

# ST



## GENERALITÀ / FEATURES

Elettropompe centrifughe per uso sommerso, di tipo multistadio con girante flottante a flusso radiale. Indicate per pozzi da 4" ed oltre. Realizzate per il sollevamento di acque chiare e limpide ed adatte ad essere utilizzate in ambito agricolo, per irrigazione, ed in ambito domestico ed industriale per pressurizzazione con autoclave della rete idrica. Portate da 0 a 24 m<sup>3</sup>/h, prevalenze da 7 a 330 metri. Massimo diametro della pompa 98 mm.

*Submersible pumps for domestic use, multistage type with floating radial impeller. Suitable for 4" wells. Designed to lift clear and clean waters, they can be used both in the agricultural field, for irrigation, and in the domestic and industrial field to pressurize the water supply with a pressure tank. Capacities from 0 to 24 m<sup>3</sup>/h, heads from 7 to 330 m. Maximum pump diameter 98 mm.*

## MATERIALI / MATERIALS

- Camicia esterna in acciaio inox AISI 304
- Flangia di accoppiamento al motore e corpo di mandata in acciaio inox AISI 304
- Albero in acciaio inox AISI 420
- Giunto di accoppiamento
- Griglia di aspirazione incorporata e Viteria in acciaio inox
- Giranti flottanti in PPO
- Diffusori in policarbonato
- Valvola di ritegno incorporata AISI 304
- Flangia di accoppiamento al motore predisposta secondo normativa NEMA

- AISI 304 stainless steel external shell
- Motor side bracket and head made of AISI 304 stainless steel
- AISI 420 stainless steel shaft
- Coupling joint
- Built-in suction grid and screws of stainless steel
- Floating impellers of PPO
- Diffusers of polycarbonate
- Built-in check valve, AISI 304
- Motor coupling flange according to NEMA standards three-phase feeding 400V with protection at user's care

## LIMITI DI IMPIEGO / OPERATING CONDITIONS

- Acqua con contenuto di sabbia 50 g/m<sup>3</sup>
- Temperatura del liquido trattato max 35°C
- Profondità max di immersione metri 350
- Tempo massimo di funzionamento a bocca chiusa: 3 min

- Maximum sand content 50 g/m<sup>3</sup>
- Maximum temperature of pumped liquid: 35°C max
- Maximum immersion depth: 350 m
- Maximum working time with closed delivery bore: 3 min

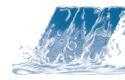

ELETTROPOMPE SOMMERSE MULTISTADIO 4"  
SUBMERSIBLE ELECTRIC PUMPS FOR 4" WELLS

CARATTERISTICHE TECNICHE A 2900 GIRI / TECHNICAL PERFORMANCE AT 2900 RPM

*Modello Model	Motore Motor		Q=Portata / Q=Capacity																		
			m³/h 0	0,3	0,6	1,5	1,8	2,1	2,4	2,7	3,0	3,6	4,2	4,8	5,4	6,0	7,2	8,4	9,6	10,8	12,0
			l/min 0	5	10	25	30	35	40	45	50	60	70	80	90	100	120	140	160	180	200
kW		HP	H=Prevalenza totale / H=Total head in meters																		
ST-0538	1,10	1,50	253	234	208	52															
ST-0552	2,20	3,00	343	315	290	84															
ST-1007	0,37	0,50	46			39	36	33	29	26	22										
ST-1010	0,55	0,75	67			58	54	49	43	36	28										
ST-1014	0,75	1,00	92			79	74	67	60	52	42										
ST-1020	1,10	1,50	139			120	111	101	90	75	60										
ST-1028	1,10	2,00	189			163	153	140	124	114	85										
ST-1040	2,20	3,00	265			225	204	187	170	148	120										
ST-1807	0,55	0,75	46			43	42	41	40	39	36	33	28	21	15	7					
ST-1809	0,75	1,00	59			55	54	52	51	49	47	43	37	28	20	10					
ST-1814	1,10	1,50	93			87	86	83	81	79	76	68	58	47	33	20					
ST-1818	1,50	2,00	120			113	111	108	105	102	98	88	75	60	42	25					
ST-1827	2,20	3,00	175			164	161	157	152	147	141	127	109	87	61	35					
ST-1835	3,00	4,00	228			212	208	203	194	191	184	166	145	119	85	46					
ST-1848	4,00	5,50	309			289	283	276	267	258	248	225	197	162	120	73					
ST-3510	1,10	1,50	62								53	51	48	45	41	38	29	18			
ST-3514	1,50	2,00	90								77	74	71	68	63	59	46	28			
ST-3520	2,20	3,00	125								107	102	97	92	86	80	62	40			
ST-3527	3,00	4,00	169								145	139	131	123	115	107	84	55			
ST-3536	4,00	5,50	221								190	181	173	164	154	143	112	72			
ST-3549	5,50	7,50	302								257	246	234	222	209	193	151	96			
ST-4006	1,10	1,50	38											35	34	33	31	28	24	19	14
ST-4008	1,50	2,00	52											47	45	44	41	37	31	25	18
ST-4013	2,20	3,00	82											75	73	71	66	59	50	40	30
ST-4017	3,00	4,00	106											98	96	94	87	79	70	58	46
ST-4023	4,00	5,50	148											134	131	127	118	108	95	79	60
ST-4032	5,50	7,50	202											182	178	172	160	143	125	105	80

*Modello Model	Motore Motor		Q=Portata / Q=Capacity																		
			m³/h 0	4,8	5,4	6,0	7,2	8,4	9,6	10,8	12,0	13,2	14,4	15,0	16,8	18,0	19,2	20,4	21,6	22,8	24,0
			l/min 0	80	90	100	120	140	160	180	200	220	240	260	280	300	320	340	360	380	400
kW		HP	H=Prevalenza totale / H=Total head in meters																		
ST-5510	1,50	2,00	58	49	48	47	44	41	37	32	27	20	13								
ST-5514	2,20	3,00	83	71	69	67	63	58	54	48	40	31	20								
ST-5518	3,00	4,00	107	92	90	87	83	77	70	62	52	39	26								
ST-5524	4,00	5,50	141	118	116	113	106	97	88	77	63	49	33								
ST-5532	5,50	7,50	189	162	157	153	144	134	122	107	90	70	47								
ST-8008	2,20	3,00	49					40	38	36	34	32	30	28	26	23	20	18	15	13	9
ST-8011	3,00	4,00	67					56	53	50	48	45	42	39	37	33	30	26	23	20	16
ST-8015	4,00	5,50	93					79	75	73	66	62	59	55	54	47	43	41	34	32	25
ST-8020	5,50	7,50	122					102	95	94	86	81	76	72	70	61	56	54	44	43	32

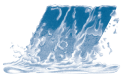

# ST

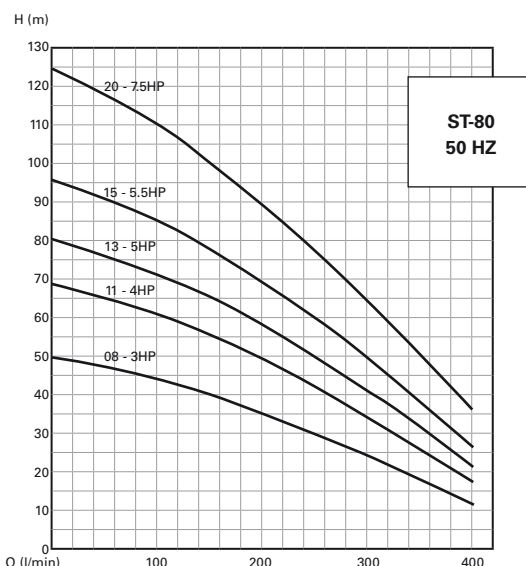
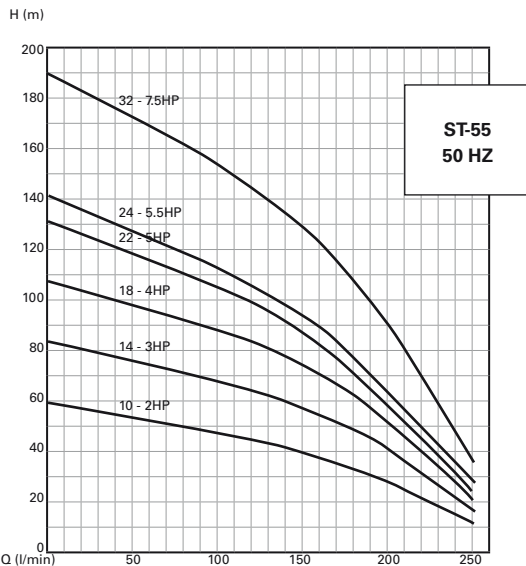
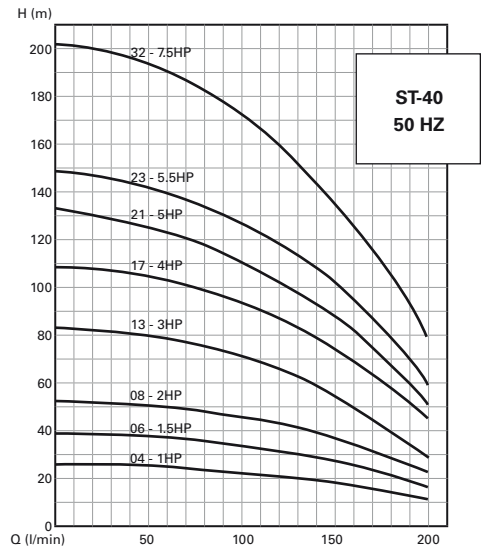
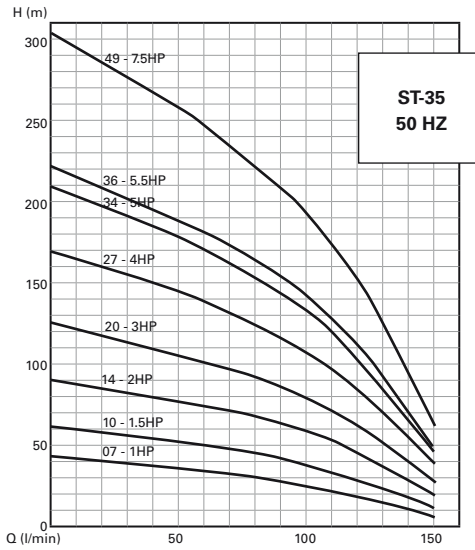
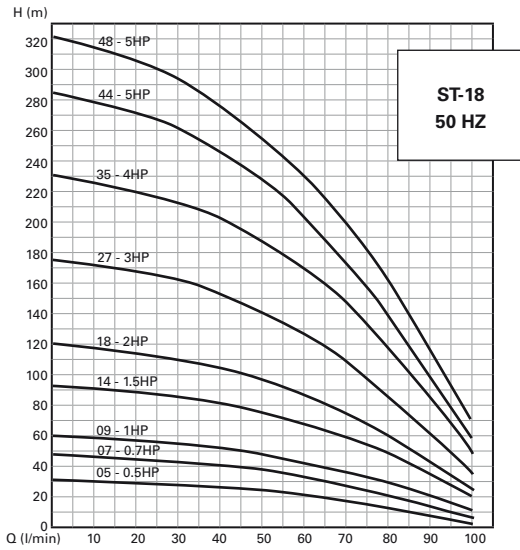
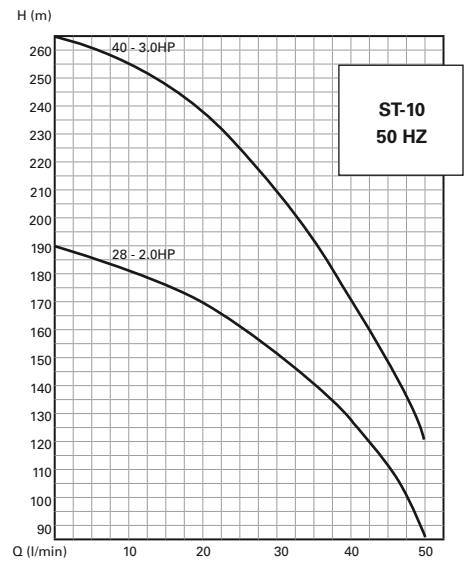
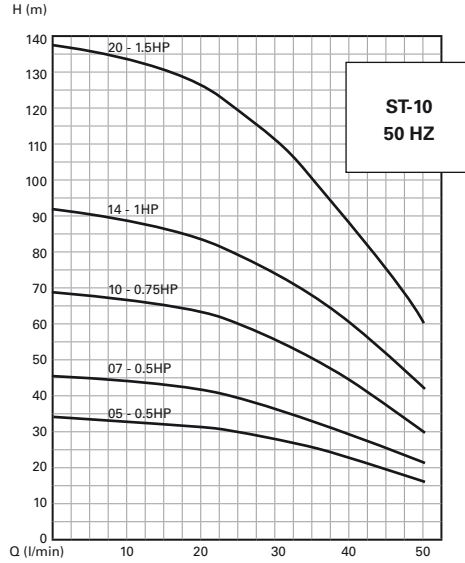
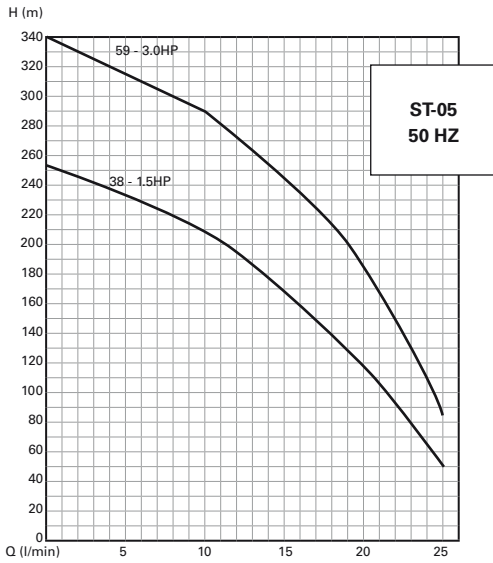

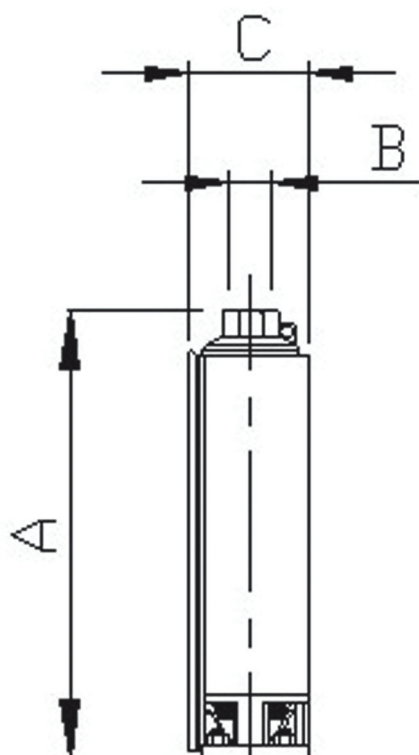
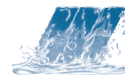

MODELLO MODEL	B	C	CORPO POMPA PUMP BODY	
			A	Peso Weight
			(mm)	(kg)
ST-0538	1" 1/4	98	864	8,20
ST-0552	1" 1/4	98	1100	12,80
ST-1007	1" 1/4	98	271	2,80
ST-1010	1" 1/4	98	324	3,40
ST-1014	1" 1/4	98	394	4
ST-1020	1" 1/4	98	499	5
ST-1028	1" 1/4	98	680	6,40
ST-1040	1" 1/4	98	880	8,80
ST-1807	1" 1/4	98	301	3,10
ST-1809	1" 1/4	98	344	3,40
ST-1814	1" 1/4	98	452	4,20
ST-1818	1" 1/4	98	538	4,90
ST-1827	1" 1/4	98	767	6,40
ST-1835	1" 1/4	98	934	8,20
ST-1848	1" 1/4	98	1253	10,3
ST-3510	2"	98	483	4,60
ST-3514	2"	98	607	5,70
ST-3520	2"	98	831	7,50
ST-3527	2"	98	1048	9,60
ST-3536	2"	98	1318	12,20
ST-3549	2"	98	1802	15,90
ST-4006	2"	98	356	3,40
ST-4008	2"	98	418	4,00
ST-4013	2"	98	573	5,50
ST-4017	2"	98	697	6,60
ST-4023	2"	98	921	8,40
ST-4032	2"	98	1238	11,00
ST-5510	2"	98	693	6,70
ST-5514	2"	98	901	8,50
ST-5518	2"	98	1147	10,40
ST-5524	2"	98	1449	13,20
ST-5532	2"	98	1866	17,00
ST-8008	2"	98	676	6,30
ST-8011	2"	98	880	8,10
ST-8015	2"	98	1149	10,10
ST-8020	2"	98	1489	13,50