



PROMOFOLDER

01/10/2023 - 31/03/2024

HERDRUK
JANUARI 2024

NIEUWIGHEDEN

Artikel	Pagina
TD002GZ04	6
HR010GZ01	7
GA050GZ	11
CE002GZ01	12
JV001GZ01	16
JV001GM201	16
ADP12	21
CF003GZ	22
CW004GZ	23
DDF489RTJ	29
DHP489RTJ	29
DBO484ZJ	42
DBO382ZJ	42
DMC300ZJ	45
DMC300RTJ	45
DDF489ZJ	54
DHP489ZJ	54
DCX200C	57
DCX201C	57
RP2302FC07	92
HW001GZ	107
DDG461Z	108
DG002GZ	108

PROMOTIES

Artikel	Promotie	Pagina
DF001GM201	E-05337 + E-05094	5
HP001GM201	E-05337 + E-05094	5
TD001GD201	DEAML006G	6
TD001GM201	DEAML006G	6
TW007GD201	E-16586	10
CE001GZ	E-12996	12
LS002GZ01	DEBWST06	17
LS004GZ01	DEBWST06	17
LS003GZ01	DEBWST06	17
DK0114G201	BL4025	18
DK0124G201	BL4025	18
DK0125G301	BL4040	18
DK0126G401	BL4040 + DC40RA	19
DK0128G601	191J97-1	19
DHR243RTJ	BL1850B	30
DHR243Z	D-42444	30
DHR243T1J	D-42444	30
DTW300RTJ	E-08458	33
DTD153RTJ	194281-7	35
DHS680RTJ	BL1850B	38
DBO380RTJ	BL1830B	42
DBO381RTJU	BL1830B	42
DCE090ZX1	E-03006-25	45
DCE090T2X1	E-03006-25	45
DGA506T1J	D-18770-10	46
DGA508T1J	D-18770-10	46
DGA506RTJ	BL1830B	46
DGA508RTJ	BL1830B	46
DTR180ZJ	191A57-9	48
DLX2289T3J	BL1830B	51
DLX2189T3J	BL1830B	51
DLX2440TJ	BL1830B	51
DLX2236TJ1	BL1830B	51
DLX2235T3J	BL1830B	51
DLX2434TJ	BL1830B	51
DLX2194PTJ	BL1830B	51
DLX2245PT1	BL1830B	51
DLX2418TJ	BL1830B	53
DLX4159TJ	2X BL1830B	53
DLX5070TJ	2X BL1830B	53
DLX5071TJ	2X BL1830B	53
DLX6115JX1	3X BL1830B	53
DLX1036TJ1	3X BL1830B	53
DLX1108TJ1	3X BL1830B	53
CLX2285AX2	DEAML103	62
DCL182Z	199491-1 + 199971-7	68
DCL280FZW	191D71-3 + 199971-7	68
DVC863LZ	2X BL1830B	74
HR4013C	P-52445	78
HR4511C	P-52445	78
HR5212C	P-52445	78
HM0871C	E-20236	79
HM1812	D-54972	80
LS1019	DEBWST06	95
LS1219	DEBWST06	95
SKR200Z	P-81315	99
SK105DZ	BL1021B + DC105B	100
SK105GDZ	BL1021B + DC105B	100
SK106DZ	BL1021B + DC105B	100
SK106GDZ	BL1021B + DC105B	100
SK10GDZ	197658-5	100
SK20GDZ	197658-5	100
SK40GDZ	197658-5	100
SK209GDZ	197658-5	100
SK312GDZ	197658-5	100
SK700DZ	197658-5	101
SK700GDZ	197658-5	101
DUC256Z001	E-08458	103
DUC356Z001	E-08458	103
DUC406Z001	E-08458	103
DUC306Z001	E-08458	103
UM600DSAEX	831253-8	103
DUM604RFEX	831253-8	103
DUM111SYX	831253-8	103
DCU180Z	199009-8	105

COMBOPACKS

Artikel	Pagina
Combopacks XGT	18-19
Combopacks LXT	51-53
Combopacks CXT	62
Combopacks slijpers	51,88
Combopacks zaagmachines	38,93
Combopacks tuin	102



Accu gereedschap

5



Stofzuigers

68



Boor- en breekhamers

77



Boormachines

81



Bevestiging

82



Metaal

83



Slijpers

84



Beton

89



Hout

90



Pneumatisch gereedschap

98



Lasers

99



Tuingereedschap

102

MAKITA WERKT VOLGENS DE RICHTLIJNEN VAN DE EPTA



EPTA staat voor European Power Tool Association en is een vereniging van de belangrijkste fabrikanten van power tools. De EPTA stelt verplichte richtlijnen op, waardoor uniforme en vergelijkbare specificaties en gegevens gegarandeerd worden. Zo zijn er richtlijnen voor het gewicht (zonder snoer maar met alle machine toebehoren die voor het normale gebruik noodzakelijk zijn), voor slagkracht, enz.

In het verleden had iedere fabrikant zijn eigen norm, daarom waren de gegevens voor de invoering van EPTA, van fabrikant tot fabrikant verschillend en niet met elkaar vergelijkbaar.

Om u zo correct mogelijk te informeren, meet Makita uitsluitend volgens de richtlijnen van de EPTA. In al onze media (catalogi, folders, website, enz.) worden daarom enkel waarden conform de EPTA-richtlijnen gebruikt.

XGT

40V **Li-ion** max



Next Generation Technology

XGT is een nieuw platform met specifieke machines, accu's en laders. De combinatie van Makita's bewezen motortechnologie, geavanceerde elektronische sturing en kwalitatieve 40Vmax-batterijen biedt een geweldig alternatief voor de meest veeleisende gebruiker. Het XGT-platform vult het bestaande CXT- en LXT platform aan maar vervangt deze niet. Het is de volgende, logische stap naar een snoerloze toekomst en zorgt voor een oplossing op accu voor de zwaarste toepassingen.

Digitale communicatie

Op het XGT-platform kunnen de machines en accu's nu ook onderling digitaal communiceren via geïntegreerde elektronica. Dat resulteert in een perfect energiemangement, optimale prestaties en bovendien een effectieve bescherming van alle componenten bij extreme belasting.

Optimaal laden

Digitaal geoptimaliseerd laadtraject met twee ventilatoren voor een perfecte temperatuurcontrole en continue actieve bijsturing van het laadtraject. Het resultaat zijn nog snellere laadtijden en een langere levensduur van de batterijen.



De nieuwste innovatie in accugereedschap



KRACHTIG



TOEKOMST-GERICHT



INTELLIGENT



BETROUW-BAAR

ACCU (KLOP-)BOOR- EN SCHROEFMACHINES



HP001G / DF001G

- Maximaal koppel tot 140 Nm
- Tot 35 % hogere snelheid
- Bestand tegen continu werken onder hoge belasting

HP / DF001 G	135
LXT 18 V	100

Laag Snelheid Hoog

Tot 35 % hogere rotatiesnelheid en meer koppel
Maakt het mogelijk om meer werk te verrichten op kortere tijd.



41 elektronische koppelinstellingen
Voor een groter instelbereik en grotere nauwkeurigheid.



Uiterst compact
In vergelijking met de LXT-variant 24 mm korter.



Active Feedback sensing Technology
Schakelt de machine uit bij een plotse zwenkbeweging.

DF001GM201 & HP001GM201: gratis gereedschapsriem E-05337 + holster E-05094

	DF001GZ01	DF001GM201	DF002GZ01	DF002GD201	HP001GZ01	HP001GM201	HP002GZ01	HP002GD201
Spanning	36 V (40Vmax)	36 V (40Vmax)	36 V (40Vmax)	36 V (40Vmax)	36 V (40Vmax)	36 V (40Vmax)	36 V (40Vmax)	36 V (40Vmax)
Bijgeleverde accu's	0	2 x BL4040	0	2 x BL4025	0	2 x BL4040	0	2 x BL4025
Lader	-	DC40RA	-	DC40RA	-	DC40RA	-	DC40RA
Max. koppel zacht / hard	68 / 140 Nm	68 / 140 Nm	30 / 64 Nm	30 / 64 Nm	68 / 140 Nm	68 / 140 Nm	30 / 64 Nm	30 / 64 Nm
Boorkop	1,5 - 13 mm	1,5 - 13 mm	1,5 - 13 mm	1,5 - 13 mm	1,5 - 13 mm	1,5 - 13 mm	1,5 - 13 mm	1,5 - 13 mm
Klopboorfunctie	-	-	-	-	✓	✓	✓	✓
Gewicht	2,7 kg	2,7 kg	2,5 kg	2,5 kg	2,7 kg	2,7 kg	2,6 kg	2,6 kg
Prijs in €	excl. btw							
	incl. btw							

NEMESIS

Makita

WWW.MAKITA.BE

4-snijder hamerboren met lasergelaste hardmetalen boorpunt

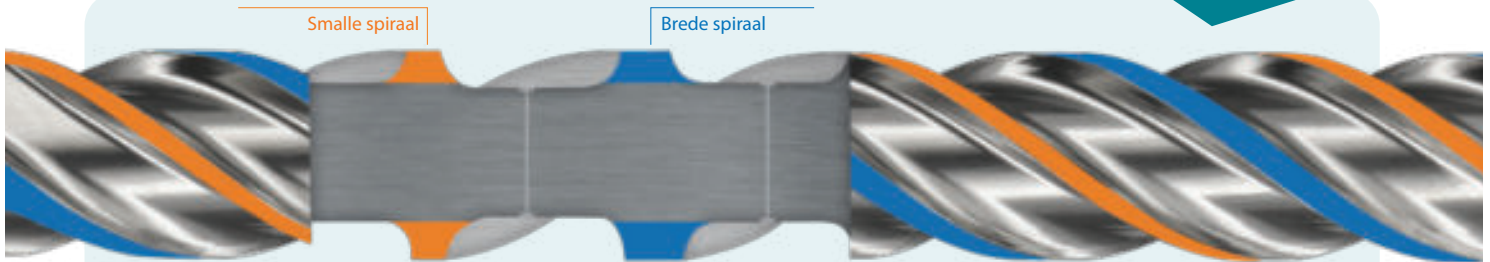

Hogere Snelheid

- > De smalle spiraal zorgt voor minder wrijving en snellere boorprestaties!
- > Vlottere afvoer van het boorgruis dankzij het lasergelaste boorpunt en de dubbele spiraal.
- > Lasergelaste carbide boorpunten t.e.m. 10 mm.

Zware klus

- > De brede spiraal zorgt voor een structurele versterking van de kern en minder last van slijtage.
- > Dankzij het robuust ontwerp is de Nemesis II-boor veilig, geschikt voor de zwaaste klus en loopt ze niet vast op betonstaal.

Langere levensduur

- > Verhoogde weerstand tegen oververhitting dankzij het lasergelaste boorpunt.
- > Het solide uit 1 stuk vervaardigd hardmetalen boorpunt zorgt voor lage vibraties en optimale boorprestaties.



ACCU SLAGSCHROEVENDRAAIERS



BL MOTOR

XGT 40V Li-ion max

TD002G

- Hamermechanisme met een dubbele veer, dit levert meer comfort op over een groot bereik van toepassingen van licht tot zwaar werk.
- Uitstekende verlichting van het werkstuk met 4 LED's



TD003GZ01



TD002GZ04



TD001GD201

Promo: gratis DEAML006G bij TD001GD201 en TD001GM201

TD003G

- Minder extra functies dan TD001G/TD002G maar uitstekende prijs/kwaliteitsverhouding
- Eenvoudige keuze van het slagenergie: 4 modi en één T-modus (voor het schroeven van zelftappende schroeven in dun metaal)



NIEUW

	TD003GZ01	TD001GZ02	TD001GD201	TD001GM201	TD002GZ04
Spanning	36 V (40Vmax)	36 V (40Vmax)	36 V (40Vmax)	36 V (40Vmax)	36 V (40Vmax)
Bijgeleverde accu's	-	-	2 x BL4025	2 x BL4040	-
Lader	-	-	DC40RA	DC40RA	-
Bitopname	1/4 " hex	1/4 " hex	1/4 " hex	1/4 " hex	1/4 " hex
Max. koppel	210 Nm	220 Nm	220 Nm	220 Nm	220 Nm
Slagkrachtniveaus	4	4	4	4	4
Hulpfuncties	1	6	6	6	6
Gewicht	1,7-2,9 kg	1,7-2,9 kg	1,7-2,9 kg	1,7-2,9 kg	1,7-2,9 kg
Prijs in €	excl. btw				
	incl. btw				

NEXT GENERATION TECHNOLOGY

ACCU HAAKSE BOORMACHINE



DA001GM101

- Zeer hoog koppel (136 Nm)
- Twee mechanische snelheden
- Ingebouwde mechanische slipkoppeling

	DA001GZ01	DA001GM101
Spanning	36 V (40Vmax)	36 V (40Vmax)
Bijgeleverde accu's	-	1 x BL4040
Bijgeleverde lader	-	DC40RA
Toerental	0 - 400 t.p.m. 0 - 1500 t.p.m.	0 - 400 t.p.m. 0 - 1500 t.p.m.
Hard koppel	70/136 Nm	70/136 Nm
Boorkop	13 mm	13 mm
Gewicht	5,3 - 6,2 kg	5,3 - 6,2 kg
Prijs in €	excl. btw	
	incl. btw	

ACCU COMBIHAMERS SDS-PLUS



HR010GZ01



HR007GM201

HR010G

- Licht, compact en toch krachtig
- Speciale behuizing en handgreep reduceren de trillingen
- Optioneel verkrijgbaar: DX16 stofafzuigingsunit
- De perfecte oplossing voor de kleinere diameters!



HR002GM204



HR009GZ02

NIEUW

	HR010GZ01	HR007GZ01	HR007GM201	HR002GZ02	HR002GM204	HR009GZ02	HR009GM202
Spanning	36 V (40Vmax)	36 V (40Vmax)	36 V (40Vmax)	36 V (40Vmax)	36 V (40Vmax)	36 V (40Vmax)	36 V (40Vmax)
Bijgeleverde accu's	-	-	2 x BL4040	-	2 x BL4040	-	2 x BL4040
Lader	-	-	DC40RA	-	DC40RA	-	DC40RA
Slagenergie	2,0 J	3,0 J	3,0 J	2,9 J	2,9 J	3,9 J	3,9 J
Max. Ø beton	20 mm	28 mm	28 mm	28 mm	28 mm	30 mm	30 mm
Trillingsniveau (ah)	10,0 m/s ²	7,5 m/s ²	7,5 m/s ²	6,0 m/s ²	6,0 m/s ²	9,1 m/s ²	9,1 m/s ²
Stofafzuigingsunit	DX16: optioneel	DX15: optioneel	DX15: optioneel	DX14: optioneel	DX14: inbegrepen	DX11: inbegrepen	DX11: inbegrepen
AWS	✓ (excl. Bluetooth unit)	✓ (excl. Bluetooth unit)	✓ (excl. Bluetooth unit)	✓	✓	✓ (excl. Bluetooth unit)	✓ (excl. Bluetooth unit)
Gewicht	2,9 - 4,5 kg	3,8 - 4,8 kg	3,8 - 4,8 kg	4,1 - 4,6 kg	4,1 - 4,6 kg	5,3 - 6,7 kg	5,3 - 6,7 kg
Prijs in €	excl. btw						
	incl. btw						

AFT Active feedback sensing technology

Deze technologie schakelt de motor onmiddellijk uit bij het plots blokkeren van de machine. De HR002G, HR007G en HR009G maken daarbij gebruik van een accelerometer die de zwenkbeweging van de machine detecteert. De AFT-technologie verhoogt de veiligheid enorm.



HR005G

- Uitstekende vermogen/gewichtsverhouding
- Beveiliging tegen terugslag (AFT met accelerometer)
- Actieve trillingsdemping (AVT)

Slagenergie
8,0 J



HR005GM202

HR006G

- 2 x 40Vmax accu's in serie zorgen voor extreme kracht
- Beveiliging tegen terugslag (AFT met accelerometer)
- Actieve trillingsdemping (AVT)



HR006GZ

Slagenergie
20,0 J



	HR005GZ01	HR005GM202	HR006GZ
Spanning	36 V (40 V _{max})	36 V (40 V _{max})	2 x 36 V (40 V _{max})
Bijgeleverde Accu's	-	2 x BL4040	-
Slagenergie	8,0 J	8,0 J	20,0 J
Slagfrequentie	1450 - 2900 min ⁻¹	1450 - 2900 min ⁻¹	1100 - 2250 min ⁻¹
Trillingsniveau (ah)	5 m/s ²	5 m/s ²	8,5 m/s ²
Capaciteit beton	40 mm	40 mm	52 mm
Toerental onbelast	250 - 500 min ⁻¹	250 - 500 min ⁻¹	250 - 310 min ⁻¹
AWS	✓	✓	✓ (excl. Bluetooth unit)
Gewicht	7,4 kg - 8,2 kg	7,4 kg - 8,2 kg	12,9 - 14,3 kg
Prijs in €	excl. btw		
	incl. btw		

NEXT GENERATION TECHNOLOGY

ACCU BREEKHAMERS SDS-MAX

BL
MOTOR

XGT
40V LITHIUM
max

XGT X2
80V max

HM001G



- Evenaart de kracht van modellen op netstroom
- Hoge slagenergie (9,4 J)
- Uitzonderlijk laag trillingsniveau dankzij actieve trillingsdemping (AVT) en een anti-vibratie behuizing



HM001GM205

Slagenergie
9,4 J



HM002GZ03

Slagenergie
20,0 J

HM002G



- Extreem krachtig dankzij twee 40Vmax accu's in serie
- Zeer hoge slagenergie (20 J)
- Uitzonderlijk laag trillingsniveau dankzij actieve trillingsdemping (AVT) en een anti-vibratie behuizing

	HM001GZ04	HM001GM205	HM002GZ03
Spanning	36 V (40Vmax)	36 V (40Vmax)	2 x 36 V (40Vmax)
Bijgeleverde accu's	-	2 x BL4040	-
Bijgeleverde lader	-	DC40RA	-
Slagenergie	9,4 J	9,4 J	20 J
Slagfrequentie	0 - 2650 min ⁻¹	0 - 2650 min ⁻¹	950 - 1900 min ⁻¹
Triax. vibratie beitelten (ah)	6,0 m/s ²	6,0 m/s ²	8,0 m/s ²
AWS	✓	✓	✓ excl. Bluetoothunit
Gewicht	6,3 - 7,1 kg	6,3 - 7,1 kg	12,0 - 13,3 kg
Prijs in €	excl. btw		
	incl. btw		

ACCU MINIBRADPISTOOL 18 GA



FN001GZ02

	FN001GZ02	FN001GA202
Spanning	36 V (40Vmax)	36 V (40Vmax)
Bijgeleverde accu's	-	2x BL4020
Bijgeleverde lader	-	DC40RA
Lengte nagels	15 - 40 mm	15 - 40 mm
Capaciteit magazijn	100	100
Makpac	✓	✓
Gewicht	2.6 - 3.2 kg	2.6 - 3.2 kg
Prijs in €	excl. btw	
	incl. btw	

ACCU PINPISTOOL 23 GA



PT001GZ01

- Werkt sneller dankzij BL motor en herontworpen indrijvingsveer
- Mechanisme met bewegend tegengewicht voor lage terugslag

	PT001GZ01	PT001GD101
Spanning	36 V (40Vmax)	36 V (40Vmax)
Bijgeleverde accu's	-	1x BL4025
Bijgeleverde lader	-	DC40RA
Lengte nagels	15 - 35 mm	15 - 35 mm
Capaciteit magazijn	120	120
Makpac	✓	✓
Gewicht	2.4 - 3.0 kg	2.4 - 3.0 kg
Prijs in €	excl. btw	
	incl. btw	

ACCU SLAGMOERSLEUTELS



TW001G

BL-motor



TW004GD201



TW007GD201



Robuust slagmechanisme

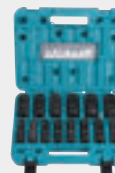

Promo: gratis 14-delige doppenset IMPACT BLACK E-16586 bij TW007GD201



Uiterst compact



217 mm TW001G



3 hulpfuncties voor het automatisch stoppen van de rotatie, zowel bij het vastdraaien als het losdraaien.

HULPFUNCTIES VOOR HET VASTDRAAIEN EN LOSDRAAIEN VAN BOUTEN

	Rechtsom (vastdraaien)	Linksom (losdraaien)
Bouffunctie	Deze functie helpt om continu schroeven erin te draaien met hetzelfde aandraaimoment. Deze functie helpt ook de kans te verkleinen dat de bouten/ moeren breken als gevolg van te strak vastdraaien.	Deze functie helpt voorkomen dat een bout eraf valt. Bij het losdraaien van een bout, zal het gereedschap automatisch stoppen of langzamer gaan draaien zodra de bout/moer voldoende los zit.
mode 1	Het gereedschap stopt automatisch zodra de slagwerking is begonnen.	Het gereedschap stopt automatisch zodra de slagwerking is gestopt.
mode 2	Het gereedschap stopt automatisch ongeveer 0,5 seconde na het moment waarop de slagwerking is begonnen.	Het gereedschap stopt automatisch ongeveer 0,2 seconde na het moment waarop de slagwerking is gestopt.
mode 3	Het gereedschap stopt automatisch ongeveer 1 seconde na het moment waarop de slagwerking is begonnen.	Het gereedschap gaat langzamer draaien nadat de slagwerking is gestopt.

	TW004GZ	TW004GD201	TW007GZ01	TW007GD201	TW001GZ01
Spanning	36 V (40Vmax)	36 V (40Vmax)	36 V (40Vmax)	36 V (40Vmax)	36 V (40Vmax)
Bijgeleverde accu's	0	2 x BL4025	0	2x BL4025	0
Bijgeleverde lader	-	DC40RA	-	DC40RA	-
Toerental	0-3200 tpm	0-3200 tpm	600-2300 tpm	600-2300 tpm	0-1800 tpm
Max. koppel	350 Nm	350 Nm	760 Nm	760 Nm	1800 Nm
Dopaansluiting	1/2"	1/2"	1/2"	1/2"	3/4"
Verpakking	-	Makpac	Makpac	Makpac	Makpac
Gewicht	1,9 - 2,2 kg	1,9 - 2,2 kg	2,7 - 3,3 kg	2,7 - 3,3 kg	3,9 - 4,2 kg
Prijs in €	excl. btw				
	incl. btw				

NEXT GENERATION TECHNOLOGY

ACCU HAAKSE SLIJPERS 125 MM



GA050G

- Compact, zeer hoog vermogen en hoog toerental
- Speciale motorbehuizing in één stuk en trillings-absorberende rubbers tussen de binnen- en buitenkant
- Vernieuwd ontwerp met kleine greepomtrek



GA023GM201



GA050GZ

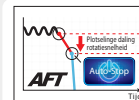

Active Feedback sensing Technology
Schakelt de motor uit bij het plots blokkeren van de schijf

STOFAFZUIGING VOOR SLIJPERS



191F81-2



191G06-2

Gereedschapsloze beschermkap

- Er is geen gereedschap nodig om de kap te monteren of te verwijderen.
- De beschermkap kan via een kliksysteem in de gewenste stand geplaatst worden.

NIEUW

	GA005GZ01	GA005GM201	GA013GZ01	GA013GM201	GA050GZ	GA023GZ	GA023GM201	GA029GZ	GA029GM201
Spanning	36 V (40Vmax)	36 V (40Vmax)	36 V (40Vmax)	36 V (40Vmax)	36 V (40Vmax)	36 V (40Vmax)	36 V (40Vmax)	36 V (40Vmax)	36 V (40Vmax)
Bijgeleverde accu's	0	2 x BL4040	0	2 x BL4040	-	0	2 x BL4040	0	2 x BL4040
Bijgeleverde lader	-	DC40RA	-	DC40RA	-	-	DC40RA	-	DC40RA
Toerental onbelast	8500 t.p.m.	8500 t.p.m.	8500 t.p.m.	8500 t.p.m.	11000 t.p.m.	3000 - 8500 t.p.m.	3000 - 8500 t.p.m.	3000 - 8500 t.p.m.	3000 - 8500 t.p.m.
Regelbaar toerental	-	-	-	-	-	✓	✓	✓	✓
Type schakelaar	Schuifschakelaar met vergrendeling	Schuifschakelaar met vergrendeling	Lepelschakelaar zonder vergrendeling	Lepelschakelaar zonder vergrendeling	Lepelschakelaar zonder vergrendeling	Schuifschakelaar met vergrendeling	Schuifschakelaar met vergrendeling	Lepelschakelaar zonder vergrendeling	Lepelschakelaar zonder vergrendeling
AWS	-	-	-	-	-	✓	✓	✓	✓
Verpakking	Makpac	Makpac	Makpac	Makpac	-	-	Makpac	-	Makpac
Gewicht	3,0 kg	3,0 kg	3,0 kg	3,0 kg	3,0 kg	3,0 kg	3,0 kg	3,0 kg	3,0 kg
Prijs in €	excl. btw								
	incl. btw								

ACCU HAAKSE SLIJPERS 125 MM X-LOCK



XLOCK

Snel en veilig schijven bevestigen via een kliksysteem.



GA044GM201



191G05-4
STOFAFZUIGKAP X-LOCK

	GA041GZ	GA041GM201	GA044GZ	GA044GM201	GA047GZ	GA047GM201
Spanning	36 V (40Vmax)	36 V (40Vmax)	36 V (40Vmax)	36 V (40Vmax)	36 V (40Vmax)	36 V (40Vmax)
Bijgeleverde accu's	-	2x BL4040	-	2x BL4040	-	2x BL4040
Bijgeleverde lader	-	DC40RA	-	DC40RA	-	DC40RA
Schijfdiameter	125 mm	125 mm	125 mm	125 mm	125 mm	125 mm
Toerental onbelast	3,000 - 8,500 min ⁻¹	3,000 - 8,500 min ⁻¹	3,000 - 8,500 min ⁻¹	3,000 - 8,500 min ⁻¹	8,500 min ⁻¹	8,500 min ⁻¹
Slijpdiepte	31 mm	31 mm	31 mm	31 mm	31 mm	31 mm
Type schakelaar	Schuifschakelaar	Schuifschakelaar	Lepelschakelaar	Lepelschakelaar	Lepelschakelaar	Lepelschakelaar
Dodemannschakelaar	-	-	✓	✓	✓	✓
AWS	✓	✓	✓	✓	-	-
Verpakking	-	Makpac	-	Makpac	-	Makpac
Gewicht	3,0 - 5,3 kg	3,0 - 5,3 kg	3,0 - 5,3 kg	3,0 - 5,3 kg	3,0 - 5,3 kg	3,0 - 5,3 kg
Prijs in €	excl. btw					
	incl. btw					

CE001G

- Uiterst krachtig dankzij 2x 40Vmax technologie
- Met soft start, AFT en elektrische rem
- Geïntegreerde watertoevoer
- XPT en Wetguard (IPX4) bescherming
- De combinatie van AVT technologie en een trillingsabsorberende behuizing zorgen voor een zeer laag vibratieniveau.



CE002GZ01

CE002G

- Versie zonder wateraansluiting, ontworpen voor droog zagen
- Met AWS & stofzuigaansluiting
- Incl. diamantschijf



CE001GZ

Promo: gratis
diamantschijf
355 mm E-12996
bij CE001GZ



NIEUW

	CE001GZ	CE002GZ01
Spanning	72 V (80Vmax)	72 V (80Vmax)
Bijgeleverde accu's/lader	-	-
Ø zaagblad	355 mm	355 mm
Toerental onbelast	5300 min ⁻¹	4200 min ⁻¹
Max. zaagdiepte	127 mm	127 mm
Trillingsniveau (ah) vooraan / achteraan	2,5 m/s ² / 1,8 m/s ²	2,5 m/s ² / 1,8 m/s ²
AWS	-	✓
Gewicht	12,3 - 14,1 kg	13,1 - 15,1 kg
Prijs in €	excl. btw	
	incl. btw	



GA038GM201



Compacte afmetingen en kleine omtrek van de handgreep

	GA035GZ	GA036GZ	GA037GZ01	GA037GM201	GA037GT201	GA038GZ01	GA038GM201	GA038GT201
Spanning	36 V (40Vmax)	36 V (40Vmax)	36 V (40Vmax)	36 V (40Vmax)	36 V (40Vmax)	36 V (40Vmax)	36 V (40Vmax)	36 V (40Vmax)
Bijgeleverde accu's	-	-	-	2 x BL4040	2 x BL4050F	-	2 x BL4040	2 x BL4050F
Bijgeleverde lader	-	-	-	DC40RA	DC40RA	-	DC40RA	DC40RA
Schijfdiameter	150 mm	150 mm	180 mm	180 mm	180 mm	230 mm	230 mm	230 mm
Toerental onbelast	8500 min ⁻¹	8500 min ⁻¹	7800 min ⁻¹	7800 min ⁻¹	7800 min ⁻¹	6600 min ⁻¹	6600 min ⁻¹	6600 min ⁻¹
Slijpdiepte	46 mm	46 mm	68 mm	68 mm	68 mm	73 mm	73 mm	73 mm
Type schakelaar	Schuifschakelaar met vergrendeling	Lepelschakelaar zonder vergrendeling	Lepelschakelaar zonder vergrendeling	Lepelschakelaar zonder vergrendeling	Lepelschakelaar zonder vergrendeling	Lepelschakelaar zonder vergrendeling	Lepelschakelaar zonder vergrendeling	Lepelschakelaar zonder vergrendeling
AWS	-	-	✓ excl. Bluetooth unit	✓ excl. Bluetooth unit	✓ excl. Bluetooth unit	✓ excl. Bluetooth unit	✓ excl. Bluetooth unit	✓ excl. Bluetooth unit
Verpakking	-	-	Koffer	Koffer	Koffer	Koffer	Koffer	Koffer
Gewicht	3,0 - 3,7 kg	3,0 - 3,7 kg	4,4 - 5,4 kg	4,4 - 5,4 kg	4,4 - 5,4 kg	4,6 - 7,4 kg	4,6 - 7,4 kg	4,6 - 7,4 kg
Prijs in €	excl. btw							
	incl. btw							

NEXT GENERATION TECHNOLOGY

ACCU METAALCIRKELZAAG 185 MM



- Grote snijcapaciteit dankzij de compacte tandwieloverbrenging
- Compartiment in aluminium voor het opvangen van metaalsnippers
- De AFT functie schakelt de motor onmiddellijk uit wanneer het zaagblad blokkeert

CS002GZ

Spanning	36 V (40Vmax)
Bijgeleverde accu's/lader	-
Ø zaagblad	185 mm
Toerental onbelast	3500 min ⁻¹
Max. zaagdiepte	67 mm
Trillingsniveau (ah)	2,5 m/s ²
Gewicht	4,2 - 5,4 kg
Prijs in €	excl. btw
	incl. btw

ACCU MENGERS



- Zeer krachtig, ook geschikt voor het mengen van zwaardere materialen
- Mechanische overbrenging met 2 snelheden
- Duimwiel voor het instellen van het maximaal toerental, variabel toerental regeling, aan-vergrendelknop en uit-vergrendelknop, softstart
- Inschroefbare ashouder met adapter M12 + M14 binnendraad
- Uitstekende bescherming van schakelaar en accu



Optioneel accessoire:
beschermkap "L" voor BL4050F en BL4080F (1911R6-2)

UT001GZ02

Spanning	36V (40Vmax)
Bijgeleverde accu's	-
Bijgeleverde lader	-
Toerental onbelast	0- 500min ⁻¹ 0- 920min ⁻¹
Aansluiting	1/2" - 20 UNF Male Adapter M12 & M14
Gewicht	5,7-7,0 kg
Prijs in €	excl. btw
	incl. btw

ACCU BETONTRILNAALDEN



VR001GZ



VR003G

ACCESSOIRES

Artikel	Diameter	Lengte	Prijs excl. btw	Prijs incl. btw
1910E1-5	32 mm	1,2 m		
1910E2-3	32 mm	1,7 m		
1910C2-9	32 mm	2,4 m		
1910E3-1	38 mm	1,2 m		
1910C4-5	38 mm	2,4 m		



	VR001GZ	VR003GZ	VR003GM101	VR004GZ	VR004GM101
Spanning	36 v (40Vmax)	36 v (40Vmax)	36 v (40Vmax)	36 v (40Vmax)	36 v (40Vmax)
Bijgeleverde accu's	-	-	1x BL4040	-	1x BL4040
Bijgeleverde lader	-	-	DC40RA	-	DC40RA
Ø trilflæs	-(enkel motor)	32 mm	32 mm	38 mm	38 mm
Lengte naald	-(enkel motor)	1,2 m	1,2 m	1,2 m	1,2 m
Trillingsfrequentie	12000-15000 min ⁻¹	12000-15000 min ⁻¹	12000-15000 min ⁻¹	12000-15000 min ⁻¹	12000-15000 min ⁻¹
Gewicht	4,8 - 7,8 kg	4,8 - 7,8 kg	4,8 - 7,8 kg	4,8 - 7,8 kg	4,8 - 7,8 kg
Prijs in €	excl. btw				
	incl. btw				



JR002GM201



JR002G

- Vermogen vergelijkbaar met model op netstroom
- Met pendelmechanisme (JR002G)
- Zeer laag trillingsniveau dankzij AVT technologie
- Handige bladontgrendelingshendel en verstelbare aanslag
- Ledverlichting



JR001GD201



Gedempte ophanging

De accu en de behuizing zijn verbonden met trillingsabsorberende rubbers.

Gereedschapsloze aanpassing van de aanslag

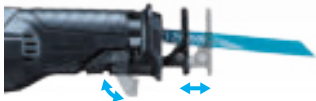

	JR001GZ	JR001GD201	JR001GM201	JR002GZ	JR002GM201
Spanning	36 V (40Vmax)	36 V (40Vmax)	36 V (40Vmax)	36 V (40Vmax)	36 V (40Vmax)
Bijgeleverde accu's	0	2 x BL4025	2 x BL4040	-	2 x BL4040
Bijgeleverde lader	-	DC40RA	DC40RA	-	DC40RA
Slaglengte	32 mm	32 mm	32 mm	32 mm	32 mm
Aantal zaagbewegingen	0 - 2300 min ⁻¹ 0 - 3000 min ⁻¹	0 - 2300 min ⁻¹ 0 - 3000 min ⁻¹	0 - 2300 min ⁻¹ 0 - 3000 min ⁻¹	0 - 3000 min ⁻¹ 0 - 3000 min ⁻¹	0 - 3000 min ⁻¹ 0 - 3000 min ⁻¹
Pendelinstelling	-	-	-	✓	✓
AVT	-	-	-	✓	✓
Gewicht	4,2 - 4,5 kg	4,2 - 4,5 kg	4,2 - 4,5 kg	4,6 - 5,8 kg	4,6 - 5,8 kg
Prijs in €	excl. btw				
	incl. btw				



PB002GM201

	PB002GZ	PB002GM201
Spanning	36 V (40Vmax)	36 V (40Vmax)
Bijgeleverde accu's	-	2x BL4040
Bijgeleverde lader	-	DC40RA
Zaagcapaciteit	127 x 127 mm	127 x 127 mm
Zaaglint	1140 x 13 x 0,5 mm	1140 x 13 x 0,5 mm
Gewicht	6,6 - 7,8 kg	6,6 - 7,8 kg
Prijs in €	excl. btw	
	incl. btw	

- Grote zaagcapaciteit tot Ø127 mm
- Variabele snelheidsregeling
- Hoge bandsnelheid
- Gemakkelijke spoorverstelling



PV001GM101



	PV001GZ	PV001GM101
Spanning	36 V (40Vmax)	36 V (40Vmax)
Bijgeleverde accu's	-	1x BL4040
Bijgeleverde lader	-	DC40RA
Diameter	180 mm	180 mm
Toerental onbelast	0 - 2200 min ⁻¹	0 - 2200 min ⁻¹
Gewicht	3,2 - 3,9 kg	3,2 - 3,9 kg
Prijs in €	excl. btw	
	incl. btw	

NEXT GENERATION TECHNOLOGY

ACCU BOVEN- EN KANTENFREES



- Compact en flexibel systeem
- Zeer hoog vermogen dankzij 40Vmax technologie
- Zachte rem
- Verschillende hulpstukken meegeleverd

RT001GM208

	RT001GZ16	RT001GM208
Spanning	36 V (40Vmax)	36 V (40Vmax)
Bijgeleverde accu's	-	2x BL4040
Bijgeleverde lader	-	DC40RA
Toerental onbelast	10000-31000 min ⁻¹	10000-31000 min ⁻¹
Max. induikdiepte	40 mm	40 mm
Ø spantang - bereik	6 - 8 mm	6 - 8 mm
Ø spantang - inbegrepen	6 mm, 8 mm	6 mm, 8 mm
AWS	✓ excl. Bluetooth unit	✓ excl. Bluetooth unit
Gewicht	2,2 - 2,5 kg	2,2 - 2,5 kg
Prijs in €	excl. btw	
	incl. btw	

ACCU SCHAAF



- Even krachtig als een machine op netstroom
- Kan tot 4,0 mm in één passage schaven
- Spaanders kunnen links of rechts uitgeworpen worden
- Zool met 3 groeven voor het afschuiven van kanten
- Sponningsdiepte tot 25 mm



KP001GM202

	KP001GZ01	KP001GM202
Spanning	36 V (40Vmax)	36 V (40Vmax)
Bijgeleverde accu's	-	2x BL4040
Bijgeleverde lader	-	DC40RA
Toerental onbelast	15000 min ⁻¹	15000 min ⁻¹
Schaafbreedte	82 mm	82 mm
Max. spaanafname	40mm	40mm
AWS	✓	✓
Gewicht	3,7 - 4,9 kg	3,7 - 4,9 kg
Prijs in €	excl. btw	
	incl. btw	

ACCU INVALCIRKELZAAG



SP001GZ03

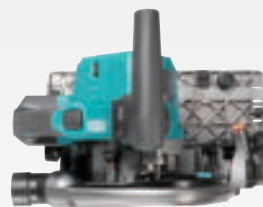

Compact en licht, perfect uitgebalanceerd.
Door het gebruik van slechts één 40Vmax accu en magnesium componenten.



Perfekte geleiding
De magnesium zool past rechtstreeks op een geleiderail.



AWS compatibel
Voor het draadloos aansturen van een AWS compatibele stofzuiger. (incl. Bluetooth unit)



Grote zaagcapaciteit
Zaagdiepte van 56 mm bij 90° en een kantelbereik van -1 tot 48°.

	SP001GZ03
Spanning	36 V (40Vmax)
Bijgeleverde accu's	-
Ø zaagblad	165 mm
Toerental onbelast	2500 - 4900 min ⁻¹
Zaagdiepte (90°)	56 mm
AWS	✓
Gewicht	4,4 - 5,0 kg
Prijs in €	excl. btw
	incl. btw

ACCU DECOUPEERZAGEN

BL
MOTOR

XGT
40V
Li-ion
max

JV001G

- Uitstekende prestaties dankzij 40Vmax technologie
- Lengte slechts 283 mm
- Breder voet voor meer stabiliteit



JV001GZ01

NIEUW

NIEUW

	JV001GZ01	JV001GM201
Spanning	36 V (40Vmax)	36 V (40Vmax)
Bijgeleverde accu's	-	2x BL4040
Bijgeleverde lader	-	DC40RA
Aantal zaagbewegingen	800 - 3500 min ⁻¹	800 - 3500 min ⁻¹
Max. capaciteit hout	135 mm	135 mm
Slaglengte	26 mm	26 mm
Gewicht	2,6 - 2,9 kg	2,6 - 2,9 kg
Verpakking	Makpac	Makpac
Prijs in €	excl. btw	
	incl. btw	

ACCU CIRKELZAGEN

BL
MOTOR

AWS
Auto-start Wireless System

XGT
40V
Li-ion
max

HS012G

- Bijzonder krachtige accucirkelzaag met links geplaatst zaagblad.
- Compact, licht en perfect uitgebalanceerd dankzij de nieuw ontwikkelde BL motor.
- Diepteregeling met duidelijk afleesbare schaal en kantelbaar tot 45°.
- De zool en beschermkap zijn uitgevoerd in hoogwaardig magnesium.
- Opgelet deze machine past niet rechtstreeks op een geleiderail.



HS012GZ01



HS003GM201



HS011GT201



HS009GT201

	HS012GZ01	HS003GZ	HS003GM201	HS004GZ	HS004GZ01	HS004GM202	HS009GZ	HS009GT201	HS010GZ	HS010GT201	HS011GZ	HS011GT201
Spanning	36 V (40Vmax)	36 V (40Vmax)	36 V (40Vmax)	36 V (40Vmax)	36 V (40Vmax)	36 V (40Vmax)	36 V (40Vmax)	36 V (40Vmax)	36 V (40Vmax)	36 V (40Vmax)	36 V (40Vmax)	36 V (40Vmax)
Bijgeleverde accu's	-	-	2 x BL4040	-	-	2 x BL4040	-	2x BL4050F	-	2x BL4050F	-	2x BL4050F
Bijgeleverde lader	-	-	DC40RA	-	-	DC40RA	-	DC40RA	-	DC40RA	-	DC40RA
Ø zaagblad	165 mm	190 mm	190 mm	190 mm	190 mm	190 mm	235 mm	235 mm	235 mm	235 mm	270 mm	270 mm
Zaagdiepte (90°)	57 mm	68,5 mm	68,5 mm	62,5 mm	62,5 mm	62,5 mm	85 mm	85 mm	85 mm	85 mm	101 mm	101 mm
Rechtstreeks op geleiderail	-	-	-	✓	✓	✓	✓	✓	-	-	✓	✓
AWS	✓	✓	✓	✓	✓	✓	✓	✓	✓	✓	✓	✓
Verpakking	Makpac	-	Makpac	-	-	Makpac	-	Koffer	-	Koffer	-	-
Gewicht	3,2 - 4,4kg	4,1 - 4,4 kg	4,1 - 4,4 kg	4,4 - 4,7 kg	4,4 - 4,7 kg	4,4 - 4,7 kg	5,1 - 5,7 kg	5,1 - 5,7 kg	6,0 - 6,4 kg	6,0 - 6,4 kg	5,5 - 6,7 kg	5,5 - 6,7 kg
Prijs in €	excl. btw											
	incl. btw											

NEXT GENERATION TECHNOLOGY

ACCU CIRKELZAGEN MET ACHTERHANDGREEP



RS001GM101



RS002GT101

RS001G / RS002G

- Speciaal ontwerp met handgreep achteraan
- Krachtig en licht (magnesium zool)



	RS001GZ	RS001GM101	RS002GZ	RS002GT101
Spanning	36 V (40Vmax)	36 V (40Vmax)	36 V (40Vmax)	36 V (40Vmax)
Bijgeleverde accu's	0	1 x BL4040	0	1 x BL4050F
Zaagdiepte (90°)	65 mm	65 mm	95 mm	95 mm
Ø zaagblad	185 mm	185 mm	260 mm	260 mm
AWS	-	-	excl Bluetooth unit	excl Bluetooth unit
Toerental onbelast	6400 min ⁻¹	6400 min ⁻¹	4000 min ⁻¹	4000 min ⁻¹
Gewicht	5,0 - 5,6 kg	5,0 - 5,6 kg	5,7 - 6,3 kg	5,7 - 6,3 kg
Prijs in €	excl. btw			
	incl. btw			

ACCU TELESCOPISCHE AFKORT - VERSTEKZAGEN



Belangrijke bedieningsknoppen zijn vooraan geplaatst



Efficiënte stofafzuiging

De geoptimaliseerde stofafzuiging met twee poorten garandeert een perfecte stofafzuiging, ook bij het zagen van dunne planken.

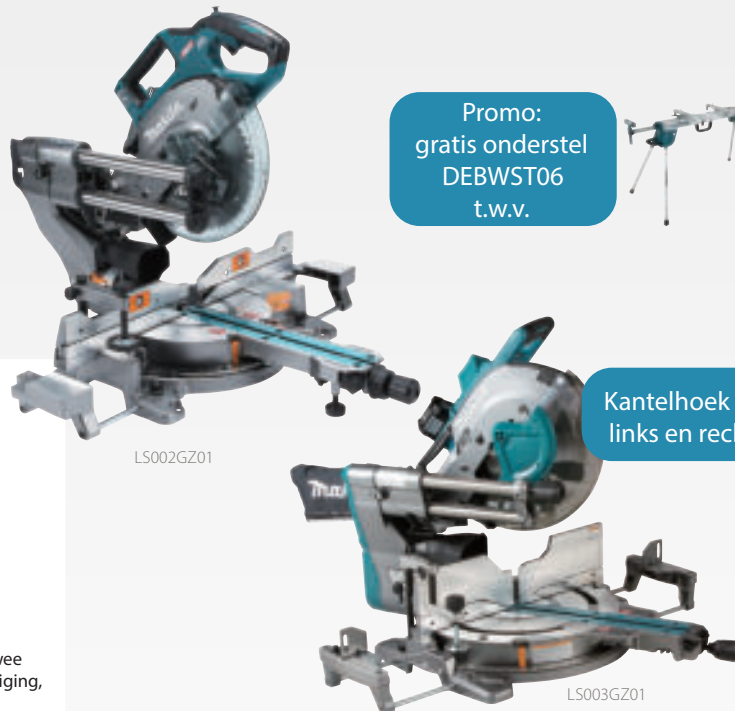

LS002GZ01

Kantelhoek 48° links en rechts

LS003GZ01

Promo:
gratis onderstel
DEBWS06
t.w.v.



Uitschuifbare zijsteunen

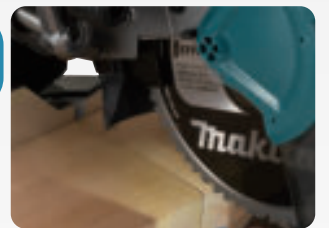

Aanduiding van de zaaglijn

Een led lamp werpt de schaduw van het zaagblad op het werkstuk, deze aanduiding is onder alle omstandigheden exact.

DXT

Deep and Exact Cutting Technology

De gepatenteerde constructie met driedubbele tandwieloverbrenging en uitsparing achter de flens laat toe om een groter deel van het zaagblad te benutten. Daardoor kunnen ook hoge plinten verticaal of in verstek afgekort worden.



Manuele bediening

De afzuiging kan via een schakelaar ook manueel gestart worden (via Bluetooth), dit is ook handig om de machine schoon te maken.

	LS002GZ01	LS004GZ01	LS003GZ01
Spanning	36 V (40Vmax)	36 V (40Vmax)	36 V (40Vmax)
Bijgeleverde accu's	0	0	0
Ø zaagblad	216 mm	260 mm	305 mm
Verstekhoek	60° L / 60° R	60° L / 60° R	60° L / 60° R
Kantelhoek	48° L / 48° R	48° L / 48° R	48° L / 48° R
Toerental onbelast	4800 min ⁻¹	3600 min ⁻¹	3600 min ⁻¹
Capaciteit	70 x 312 mm	91 x 312 mm	107 x 312 mm
AWS	✓	✓	✓
DXT	✓	✓	✓
Gewicht	16,4 - 17,0 kg	26,6 - 27,2 kg	30,5 - 31,1 kg
Prijs in €	excl. btw		
	incl. btw		

COMBOPACK XGT



Promo: gratis
extra accu 2,5 Ah

DK0114G201

Bijgeleverde accu's	2 x BL4040
Bijgeleverde lader	DC40RA
Laadadapter	ADP10
Klopboor- en schroef- machine	HP001G
Slagschroevendraaier	TD001G
Verpakking	Gereedschapstas
Prijs in €	excl. btw incl. btw

COMBOPACK XGT



Promo: gratis
extra accu 2,5 Ah

DK0124G201

Bijgeleverde accu's	2 x BL4040
Bijgeleverde lader	DC40RA
Boor- en schroefmachine	DF001G
Haakse slijper 125 mm	GA005G
Verpakking	Makpac
Prijs in €	excl. btw incl. btw

COMBOPACK XGT



Promo: gratis
extra accu 4,0 Ah

DK0125G301

Bijgeleverde accu's	2 x BL4040
Bijgeleverde lader	DC40RA
Boor- en schroefmachine	DF001G
Slagschroevendraaier	TD001G
Haakse slijper 125 mm	GA005G
Verpakking	Makpac
Prijs in €	excl. btw incl. btw

NEXT GENERATION TECHNOLOGY

COMBOPACK XGT

XGT
40V Li-ion
max

Promo: gratis extra
accu 4,0 Ah + extra
lader DC40RA



DK0126G401

Bijgeleverde accu's	2 x BL4040
Bijgeleverde lader	DC40RA
Haakse slijper 125 mm	GA005G
Reciprozaag	JR001G
Boor- en schroefmachine	DF001G
Slagschroevendraaier	TD001G
Verpakking	Gereedschapstas
Prijs in €	excl. btw
	incl. btw

COMBOPACK XGT

XGT
40V Li-ion
max



Promo: gratis
Powerpack 4,0 Ah
t.w.v.

DK0128G601

Bijgeleverde accu's	2 x BL4040
Bijgeleverde lader	DC40RA
Boor- en schroefmachine	DF001G
Slagschroevendraaier	TD001G
Haakse slijper 125 mm	GA005G
Reciprozaag	JR001G
SDS plus combihamer	HR002G
Cirkelzaag 190 mm	HS003G
Verpakking	Gereedschapstas
Prijs in €	excl. btw
	incl. btw

HET XGT-PLATFORM



AS001GZ

Blaas- en zuig-
machine 40Vmax
Prijs excl. BTW

Prijs incl. BTW



Karton

CF002GZ

Ventilator 40Vmax
Prijs excl. BTW

Prijs incl. BTW



Karton

CL001GZ05

Staalstofzuiger
40Vmax
Prijs excl. BTW

Prijs incl. BTW



Karton

CL002GZ03

Staalstofzuiger
40Vmax
Prijs excl. BTW

Prijs incl. BTW



Karton

CL002GZ07

Staalstofzuiger
40Vmax
Prijs excl. BTW

Prijs incl. BTW



Karton

CL003GZ04

Staalstofzuiger
40Vmax
Prijs excl. BTW

Prijs incl. BTW



Karton

CS002GZ

Metaalcirkel-
zaag 40Vmax
Prijs excl. BTW

Prijs incl. BTW



Karton

DA001GZ01

Haakse boor-
machine 40Vmax
Prijs excl. BTW

Prijs incl. BTW



Koffer

DF001GZ01

Boor- en schroef-
machine 40Vmax
Prijs excl. BTW

Prijs incl. BTW



Makpac

DF002GZ01

Boor- en schroef-
machine 40Vmax
Prijs excl. BTW

Prijs incl. BTW



Makpac

FN001GZ02

Minibradpistool
40Vmax
Prijs excl. BTW

Prijs incl. BTW



Makpac

GA013GZ01

Haakse slijper
125 mm 40Vmax
Prijs excl. BTW

Prijs incl. BTW



Makpac

GA029GZ

Haakse slijper
125 mm 40Vmax
Prijs excl. BTW

Prijs incl. BTW



Karton

GA038GZ01

Haakse slijper
230 mm 40Vmax
Prijs excl. BTW

Prijs incl. BTW



Koffer

GA041GZ

X-Lock haakse slijper
125 mm 40Vmax
Prijs excl. BTW

Prijs incl. BTW



Karton

GA044GZ

X-Lock haakse slijper
125 mm 40Vmax
Prijs excl. BTW

Prijs incl. BTW



Karton

HP001GZ01

Klopboor- en schroef-
machine 40Vmax
Prijs excl. BTW

Prijs incl. BTW



Makpac

HP002GZ01

Klopboor- en schroef-
machine 40Vmax
Prijs excl. BTW

Prijs incl. BTW



Makpac

HR002GZ02

SDS-PLUS Combihamer
40Vmax
Prijs excl. BTW

Prijs incl. BTW



Makpac

HR005GZ01

SDS-Max Combihamer
40Vmax
Prijs excl. BTW

Prijs incl. BTW



Koffer

HR006GZ

SDS-Max Combihamer
40Vmax
Prijs excl. BTW

Prijs incl. BTW



Koffer

HR007GZ01

SDS-PLUS Combihamer
40Vmax
Prijs excl. BTW

Prijs incl. BTW



Koffer

HR009GZ02

SDS-PLUS Combihamer
40Vmax
Prijs excl. BTW

Prijs incl. BTW



Koffer

HS004GZ

Cirkelzaag 190 mm
40Vmax
Prijs excl. BTW

Prijs incl. BTW



Karton

HS009GZ

Cirkelzaag 190 mm
40Vmax
Prijs excl. BTW

Prijs incl. BTW



Karton

HS010GZ

Cirkelzaag
235 mm 40Vmax
Prijs excl. BTW

Prijs incl. BTW



Karton

HS011GZ

Cirkelzaag 270 mm
40Vmax
Prijs excl. BTW

Prijs incl. BTW



Karton

HS012GZ01

Cirkelzaag 165 mm
40Vmax
Prijs excl. BTW

Prijs incl. BTW



Makpac

JR001GZ

Reciprozaag 40Vmax
Prijs excl. BTW

Prijs incl. BTW



Karton

JR002GZ

Reciprozaag 40Vmax
Prijs excl. BTW

Prijs incl. BTW



Karton

KP001GZ01

Schaaf 40Vmax
Prijs excl. BTW

Prijs incl. BTW



Karton

KT001GZ

Waterkoker 40Vmax
Prijs excl. BTW

Prijs incl. BTW



Karton

MP001GZ

Luchtpomp
40Vmax
Prijs excl. BTW

Prijs incl. BTW



Karton

PB002GZ

Bandzaag 40Vmax
Prijs excl. BTW

Prijs incl. BTW

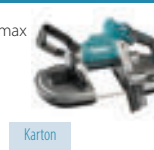

Karton

PT001GZ01

Pinpistool
40Vmax
Prijs excl. BTW

Prijs incl. BTW



Makpac

PV001GZ

Polijstmachine
40Vmax
Prijs excl. BTW

Prijs incl. BTW



Karton

RS001GZ

Wormzaag 185 mm
40Vmax
Prijs excl. BTW

Prijs incl. BTW



Karton

RS002GZ

Wormzaag 260 mm
40Vmax
Prijs excl. BTW

Prijs incl. BTW



Karton

RT001GZ16

Boven- en kan-
tenfrees 40Vmax
Prijs excl. BTW

Prijs incl. BTW



Makpac

SP001GZ03

Invalcirkelzaag
40Vmax
Prijs excl. BTW

Prijs incl. BTW



Makpac

TD003GZ01

Slagschroevendraaier
40Vmax
Prijs excl. BTW

Prijs incl. BTW



Makpac

TW001GZ01

Slagmoersleutel
40Vmax
Prijs excl. BTW

Prijs incl. BTW



Makpac

TW004GZ

Slagmoersleutel
40Vmax
Prijs excl. BTW

Prijs incl. BTW



Karton

TW007GZ01

Slagmoersleutel
40Vmax
Prijs excl. BTW

Prijs incl. BTW



Makpac

UT001GZ02

Menger 40Vmax
Prijs excl. BTW

Prijs incl. BTW



Karton

VC002GLZ01

Stofzuiger 40Vmax
Prijs excl. BTW

Prijs incl. BTW



Karton

VC003GLZ

Stofzuiger 40Vmax
Prijs excl. BTW

Prijs incl. BTW



Karton

VC005GLZ

Stofzuiger 40Vmax
Prijs excl. BTW

Prijs incl. BTW



Karton

VR003GZ

Betontrilnaald
40Vmax
Prijs excl. BTW

Prijs incl. BTW

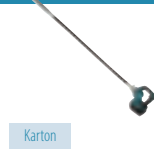

Karton

VR004GZ

Betontrilnaald
40Vmax
Prijs excl. BTW

Prijs incl. BTW

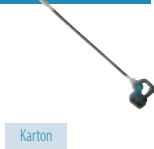

Karton



XGT
Power 2 Choose

1. CHOOSE YOUR BODY!

2. CHOOSE YOUR POWER!

3. MIX IT UP!



XGT
40V Li-ion
max



* Laadtijd met DC40RA

191E07-8
Oplader DC40RA
Snellader voor XGT 40Vmax accu's



191N09-8
Duo snellader DC40RB
Duo snellader voor het gelijktijdig laden van twee XGT 40Vmax accu's



191C10-7
ADP10 Laadadapter
Adapter om LXT 14,4 V en 18 V accu's te laden op een XGT 40Vmax lader



1911L9-4
Duo oplader DC40WA
Traaglader voor XGT 40Vmax accu's



NIEUW

1910D9-2
Communicatieadapter ADP12

Adapter om XGT-machines te verbinden met smartphone, laptop, ...
* de adapter wordt enkel tussen machine en accu geplaatst tijdens controle / bij het maken van de gewenste instellingen



NIEUW

- Diefstalbeveiliging instellen d.m.v. een pincode
- De werkingsduur van accu's instellen
- De gebruikshistoriek van de XGT-machines raadplegen

COMPRESSOR **BL MOTOR** XGT **40V^{Li-ion}max**

- Compact en lichtgewicht ontwerp, ideaal voor binnentoepassingen zoals nieten en spijkeren
- Olivrijne pomp met hoog luchtdebiet
- Manometer voor zowel tank- als uitgangsdruk
- Laag geluidsniveau
- Stevig metalen frame beschermt de motor en vergemakkelijkt het transport



AC001GZ	
Spanning	36V (40Vmax)
Bijgeleverde accu's	-
Debiet	34 l/min @ 6,0 bar
Inschakeldruk	7,2 bar
Uitschakeldruk	9,4 bar
Uitgangsdruk	0 - 9,3 bar
Geluidsdrukkniveau	68 dB(A)
Tankinhoud	7,6 L
Gewicht	10,1 - 12,8 kg
Prijs in €	excl. btw
	incl. btw

LUCHTPOMP **BL MOTOR** XGT **40V^{Li-ion}max**



- Door het hoge debiet kunnen grotere banden en bijvoorbeeld ook speelgoed voor op het water opgeblazen worden.
- Drie modi: hoog debiet, laag debiet en "ball" mode om op een veilige manier speelballen op te blazen.
- Functie voor het aflaten van lucht indien de druk te hoog is.

MP001GZ	
Spanning	36 V (40Vmax)
Bijgeleverde accu's	0
Debiet	12 - 24 l/min
Max. druk	11,1 bar
Gewicht	2,9 - 3,5 kg
Prijs in €	excl. btw
	incl. btw

BLAAS- EN ZUIGMACHINE **BL MOTOR** XGT **40V^{Li-ion}max**

- 4 vermogenstanden en variabele snelheid
- Handig kliksysteem voor het verwisselen van mondstukken
- Kan ook lucht wegzuigen via een optioneel accessoire
- Standaard geleverd met 5 blaasmonden



Toepassingen:

- Schoonblazen (gereedschap, machines, computers).
- Reinigen van luchtfilters
- Uitblazen van ankerkragen
- Opblazen/aflaten van strandballen, bootjes enz.
- Leegzuigen van verpakkingen (compacteer maken)



• Standaard



• Optioneel



AS001GZ	
Spanning	36 V (40Vmax)
Bijgeleverde accu's	-
Bijgeleverde lader	-
Blaaskracht	2,8 N
Debiet	0 - 1,3 m³/min
Max. onderdruk	103 mbar
Gewicht	1,5 - 2,3 kg
Prijs in €	excl. btw
	incl. btw

ACCU VENTILATOREN **BL MOTOR** XGT **40V^{Li-ion}max**

AC adapter inbegrepen



CF001GZ



CF002GZ



CF003GZ

CF003G

- Werkt op 40Vmax, 18V of netstroom (middels adapter)
- Extra grote schoepen zorgen voor een groot debiet en stille werking
- Traploze snelheidsregeling



CF003G

NIEUW

	CF001GZ	CF002GZ	CF003GZ
Spanning	36 V (40Vmax) XGT / AC (Incl. AC-adapter)	36 V (40Vmax) XGT / AC (Incl. AC-adapter)	36 V (40Vmax) XGT / 18 V LXT / AC (Incl. AC-adapter)
Diameter	235 mm	330 mm	450 mm
Debiet (stand 1-2-3)	5,2 / 6,5 / 8,2 m³/min	18 / 26 / 37 m³/min	38 - 120 m³/min
Luchtsnelheid	120 / 150 / 190 m/min	120 / 170 / 240 m/min	96 - 300 m/min
Gewicht	2,0 - 3,0 kg	4,5 - 5,1 kg	7,9 - 10,5 kg
Prijs in €	excl. btw		
	incl. btw		

MICROGOLFOVEN



- Ideaal om voeding op te warmen op plaatsen waar geen netstroom beschikbaar is.
- Werkt met één 40Vmax accu of twee in parallel.
- Compact, gemakkelijk te transporteren.
- Vermogenniveaus: 350W en 500W
- De verwarmingstijd kan ingesteld worden van 10 seconden tot 20 minuten.
- Met 2x BL4040 en op volle vermogen kunnen ongeveer 5 maaltijden of 8 koppen van 200 ml opgewarmd worden.

		MW001GZ
Spanning		36V (40Vmax)
Bijgeleverde accu's		-
Bijgeleverde lader		-
Inhoud		8 l
Binnenafmetingen		255 x 241 x 120 mm
Uitgangsvermogen		350 W / 500 W
Autonomie (2x BL4040)		350 W: 21 min 500 W: 15 min
Gewicht		9,5 - 12,7 kg
Prijs in €	excl. btw	
	incl. btw	

WATERKOKER



- Voeding met één XGT accu of twee in parallel
- Dubbellaagse roestvrijstalen wand
- Met voedingsstandaard en groot handvat
- Uitgerust met morsbeveiliging

		KT001GZ
Spanning		36 V (40Vmax)
Inhoud		0,8 l
Kooktijd voor 0,8 l		ca. 8 min
Verwarmcapaciteit 100 °C		1,2 l met 2 x BL4025
Gewicht		2,8 - 5,9 kg
Prijs in €	excl. btw	
	incl. btw	

VRIES-/ KOELBOX MET VERWARMFUNCTIE



CW004G

- Capaciteit van 29 l
- Uiterst efficiënt en groot koelvermogen door het gebruik van een compressor
- De ruimte kan onderverdeeld worden in twee vakken met elk een eigen temperatuurstelling, bijvoorbeeld een koel- en vriesvak. Standaard geleverd met binnenbakje en binnenmand
- Het deksel kan aan beide zijden geopend worden of volledig verwijderd voor het gemakkelijk reinigen
- Met beugel om te rollen op de wielen en ook voorzien van inklabare handvaten zijdelings om gemakkelijk te dragen



CW003GZ



CW002GZ01



CW004GZ



CW004GZ



Leverbaar vanaf januari 2024

NIEUW

	CW003GZ	CW001GZ01	CW004GZ	CW002GZ01
Voeding	36 V (40Vmax) XGT / 18 V LXT / AC / 12 V DC - 24 V DC	36 V (40Vmax) XGT / 18 V LXT / AC / 12 V DC - 24 V DC	36 V (40Vmax) XGT / 18 V LXT / AC / 12 V DC - 24 V DC	36 V (40Vmax) XGT / 18 V LXT / AC / 12 V DC - 24 V DC
Inhoud	7 l	20 l	29 l	50 l
Koelen	-18 / -15 / -10 / -5 / 0 / 5 / 10 °C	-18 / -15 / -10 / -5 / 0 / 5 / 10 °C	-18 / -15 / -10 / -5 / 0 / 5 / 10 °C	-18 / -15 / -10 / -5 / 0 / 5 / 10 °C
Verwarmen	30 / 35 / 40 / 45 / 50 / 55 / 60 °C	30 / 35 / 40 / 45 / 50 / 55 / 60 °C	30 / 35 / 40 / 45 / 50 / 55 / 60 °C	30 / 35 / 40 / 45 / 50 / 55 / 60 °C
Autonomie ca.	-18 °C: 5,5 uur, 5 °C: 13,5 uur, 60 °C: 5,5 uur (1x BL4040)	-18 °C: 8 uur, 5 °C: 22,5 uur, 60 °C: 7 uur (2x BL4040)	-18 °C: 10,0 h, 5 °C: 24,0 h (at 30 °C) 60 °C: 9,0 h (at 0 °C) Dual room mode (left -18 °C, right 5 °C): 9,0 h	-18 °C: 8 uur, 5 °C: 19,5 uur, 60 °C: 4,5 uur (2x BL4040)
Afmetingen	456 x 245 x 308 mm	663 x 341 x 372 mm	676 x 345 x 471 mm	867 x 465 x 476 mm
Gewicht		7,9 - 9,4 kg	13,8 - 17,3 kg	17,5 - 20,9 kg
Prijs in €	excl. btw			
	incl. btw			



CW004GZ

Het grootste 18 V Lithium-ion assortiment ter wereld.

Meer dan 380 machines met slechts één accu.

18V
LITHIUM-ION

3
JAAR
GARANTIE
OP MACHINES
Na registratie op
www.makita.be

LXT

Lithium-Ion Extreme Technology

- + Performante Lithium-Ion accu's
- + Een unieke en snelle oplaadtechnologie
- + Energie-efficiënte koolborstelloze motoren
- + Meervoudige bescherming tegen overbelasting





Invalcirkelzaag

Kettingzaag

Hoogsnoeier

Grastrimmer

Grasmaaiers

Hogedrukreiniger

Vacuumpomp

Slagmoersleutels

Boormachine

Slagschroevendraaiers

Schroefmachines

2x 18V

18V

Schroefautomaten

Haakse slag-schroevendraaiers

Slagschroevendraaiers

Ratelmoeisleutel

Schroefmachines

Haakse boormachines

Klopboormachines

Boor- en schroefmachines

Bijl. met

Boorhamers

Combihamers SDS-plus

Stofzuiger

Boven- en kantenfrees

Reciprozagen

Multitool

Knabbelschaar

Schuurpolijst-machine

Draadstangknippers

Zaagmachines

Bandzagen

Metaalcirkelzagen

Gipszaag

Band-schuurmachine

Cirkelzagen

Langnek-schuurmachine

Handpalm-schuurmachines

Polijstmachines

Lamellenfrees

Decoupeerzagen

Afkort-verstekzagen

18V LITHIUM-ION

LXT-Platform

Betrouwbaar – veelzijdig – krachtig

Snel en optimaal laden

Wanneer de batterijen warm zijn, dan is het belangrijk dat die eerst gekoeld worden vooraleer het laadtraject te starten. De lader is uitgerust met een ventilator die de batterijen koelt vóór en tijdens het laden om de laadtijd te verkorten.

Makita geavanceerd laadsysteem
Geforceerde koeling



Snelladen



Standaard laadsysteem
Natuurlijke warmteafvoer



Langere laadtijd



3.0Ah
Li-ion

22 minuten

3,0 Ah
BL1830B

SNELSTE LAADTIJD

4.0Ah
Li-ion

36 minuten

4,0 Ah
BL1840B

5.0Ah
Li-ion

45 minuten

5,0 Ah
BL1850B

6.0Ah
Li-ion

55 minuten

6,0 Ah
BL1860B

LANGSTE WERKDUUR



STROOMOMVORMER BAC01



EUABAC01



PDC niet inbegrepen

- Converteert de accuspanning naar een 230V/50 Hz wisselspanning voor het gebruik van machines op netstroom
- BAC01 is de omvormer, deze dient gevoed te worden met het accupack PDC1200 of PDC01
- Maximale continue belasting (met PDC1200): 1400 W (VA), piekbelasting 2800 W (VA)
- De hoogwaardige electronica produceert een zuivere sinusgolf waardoor ook gevoelige apparatuur mag aangesloten worden
- Verschillende uitgangen: 2x AC 230 V, 2x USB type A, 2x USB type C en 12V
- Duidelijke weergave van de actuele belasting
- Beveiligd tegen overbelasting

DRAAGBAAR ACCUPACK

PDC01

PDC1200

191A59-5

PDC01 ZONDER BATTERIJEN

Inclusief adapter
18 V & 2 x 18 V



191C50-5

PDC01 MET 4 x BL1850B EN
DUOSNELLADER DC18RD

PDC01 KAN TOT 4 LXT-
BATTERIJEN DRAGEN



BL1850B

DC18RD

BEAPDC1200A01

DRAAGBAAR ACCUPACK PDC1200
MET GEÏNTEGREERDE BATTERIJCELLEN

ENERGIECAPACITEIT
1206 Wh



Inclusief lader 191L00-4
(DC4001) en adapter
191J51-5 (2 x 18 V)

197280-8
accu BL1850B 18V 5,0 Ah



197288-2
TWINPACK 18V 2 x 5,0 Ah



197422-4
accu BL1860B 18V 6,0 Ah



DECADP05
USB-adapter
USB-adapter voor 14,4V/18V accu's



197494-9
POWERPACK 18V 2 x 4,0 Ah



197624-2
POWERPACK 18V 2 x 5,0 Ah



197629-2
POWERPACK 18V 2 x 5,0 Ah



197626-8
POWERPACK 18V 4 x 5,0 Ah



198116-4
Powerpack 18V 2 x 6,0 Ah



198077-8
POWERPACK 18V 2 x 6,0 Ah



198091-4
POWERPACK 18V 4 x 6,0 Ah



198170-8
Accu timer LXT BPS01
Programmeert de werkingsduur
van 14,4V & 18V accu's



195584-2
OPLADER DC18RC
Snellader voor LXT accu's van 14,4/18V



196933-6
DUBBELLADER DC18RD
Duo snellader voor LXT accu's: 14,4/18V



2 accu's BL1850 laden
in 45 minuten

198720-9
OPLADER DC18RE
Snellader voor zowel CXT als LXT accu's



LXT

CXT

196426-3
Oplader DC18SF
Traaglader voor LXT accu's, 4 poorten
Laadt twee accu's tegelijk op



ACCU BOOR- EN SCHROEFMACHINE

14.4V
LITHIUM-ION



incl. 59 accessoires

DDF343RYX2

DDF343RYX2

Spanning	14,4 V
Bijgeleverde accu's	2 x BL1415N
Hard koppel	36 Nm
Boorkop	1-10 mm
Gewicht	1,4 kg
Prijs in €	excl. btw
	incl. btw

ACCU (KLOP-)BOOR- EN SCHROEFMACHINE

18V
LITHIUM-ION



DHP453RFX2

incl. 96 accessoires

DHP453RFX2

Spanning	18 V
Bijgeleverde accu's	2 x BL1830B
Hard koppel	42 Nm
Boorkop	1,5-13 mm
Gewicht	1,7 kg
Prijs in €	excl. btw
	incl. btw

ACCU (KLOP-)BOOR- EN SCHROEFMACHINES

MAK PAC

18V
LITHIUM-ION



DDF484RT3J



DDF486RT3J

PROMO

3e accu

	DDF453RF3J	DDF482RT3J	DDF484RT3J	DDF486RT3J	DHP486RT3J
Spanning	18 V	18 V	18 V	18 V	18 V
Bijgeleverde accu's	3 x BL1830B	3 x BL1850B	3 x BL1850B	3 x BL1850B	3 x BL1850B
BL-motor	-	-	✓	✓	✓
Klopboorfunctie	-	-	-	-	✓
Hard koppel	42 Nm	62 Nm	54 Nm	130 Nm	130 Nm
Boorkop	1,5-13 mm	1,5-13 mm	1,5-13 mm	1,5 - 13 mm	1,5 - 13 mm
Gewicht	1,7 kg	1,7 kg	1,5 kg	2,3 - 2,6 kg	2,3 - 2,7 kg
Prijs in €	excl. btw				
	incl. btw				

ACCU (KLOP-)BOOR- EN SCHROEFMACHINES



DDF489/DHP489

- Uiterst krachtige en compacte machine voor all-round gebruik
- Volledig metalen boorkop



	DDF083ZJ	DDF487RAJ	DDF485RTJ
Spanning	18 V	18 V	18 V
Bijgeleverde accu's	-	2 x BL1820	2 x BL1850B
Klopboorfunctie	-	-	-
Hard koppel	40 Nm	40 Nm	50 Nm
Opname	1/4 hex	1,5 - 13 mm	1,5-13 mm
Gewicht	1,1 - 1,4 kg	1,3 - 1,6 kg	1,4 kg
Prijs in €	excl. btw		
	incl. btw		

Wist je dat er van DDF484 en DHP486 ook de voordelige uitvoeringen DDF484Z / DDF484T1J en DHP486Z / DHP486T1J bestaan? Zie p. 52 - 53 voor meer info!

NIEUW

NIEUW

	DDF484RTJ	DDF489RTJ	DDF486RTJ	DHP487RAJ	DHP485RFJ	DHP484RTJ	DHP489RTJ	DHP486RTJ
Spanning	18 V	18 V	18 V	18 V	18 V	18 V	18 V	18 V
Bijgeleverde accu's	2 x BL1850B	2 x BL1850B	2 x BL1850B	2 x BL1820	2 x BL1830B	2 x BL1850B	2 x BL1850B	2 x BL1850B
Klopboorfunctie	-	-	-	✓	✓	✓	✓	✓
Hard koppel	54 Nm	73 Nm	130 Nm	40 Nm	50 Nm	54 Nm	73 Nm	130 Nm
Opname	1,5-13 mm	1,5-13 mm	1,5-13 mm	1,5 - 13 mm	1,5-13 mm	1,5-13 mm	1,5 - 13 mm	1,5 - 13 mm
Gewicht	1,6 - 2,2 kg	1,8 - 2,5 kg	2,3 - 2,7 kg	1,3 - 1,6 kg	1,4 - 1,7 kg	1,6 - 2,2 kg	1,8 - 2,5 kg	2,3 - 2,7 kg
Prijs in €	excl. btw							
	incl. btw							

ACCU HAAKSE BOORMACHINES



	DDA350RTJ	DDA351RTJ	DDA450RTE	DDA460ZK
Spanning	18 V	18 V	18 V	2 x 18 V
Bijgeleverde accu's	2 x BL1850B	2 x BL1850B	2 x BL1850B	-
Toerental	0-1800 t.p.m.	0-1800 t.p.m.	0 - 450 t.p.m. 0 - 1400 t.p.m.	0-350 t.p.m. 0-1400 t.p.m.
BL motor	-	-	✓	✓
XPT	-	-	✓	✓
Hard koppel	13,7 Nm	13,7 Nm	26/70 Nm	70/136 Nm
Boorkop	1,5-10 mm	1,5-10 mm	1,5-13 mm	1,5-13 mm
Gewicht	1,8 kg	1,8 kg	3,2 kg	5,7 kg
Prijs in €	excl. btw			
	incl. btw			

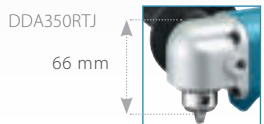

ACCU BIKHAMER SDS-PLUS



18V LITHIUM-ION

BL MOTOR

AVT

XPT
EXTREME PROTECTION TECHNOLOGY



DHK180RTJ



		DHK180ZJ	DHK180RTJ
Spanning		18V	18V
Bijgeleverde accu's		0	2 x BL1850B
Slagenergie		3,1 J	3,1 J
Slagfrequentie		0 - 3200/min	0 - 3200/min
Triaxiale vibratiewaarde (ah)		4,5 m/s ²	4,5 m/s ²
Gewicht		3,3 kg	3,3 kg
Prijs in €	excl. btw		
	incl. btw		

ACCU BOORHAMERS SDS-PLUS

AWS



18V LITHIUM-ION



DHR171RTJ



PROMO
Gratis 3e BL1850B bij DHR243RTJ



DHR202RTJ



DHR182RTWJ



DHR243RTJ



DHR183RTWJ

PROMO

Gratis 17-delige booren bitset D-42444 bij DHR243Z en DHR243T1J



Wist je dat er van DHR243 ook de voordelige uitvoeringen DHR243Z en DHR243T1J bestaan? Zie p. 52-53 voor meer info!

DHR182RTWJ
DHR243RTJW
DHR183RTWJ
incl. STOF AFZUIGING



		DHR171RTJ	DHR183RTWJ	DHR202RTJ	DHR182RTJ	DHR182RTWJ	DHR243RTJ	DHR243RTJW
Spanning		18V	18V	18V	18V	18V	18V	18V
Bijgeleverde accu's		2 x BL1850B	2 x BL1850B	2 x BL1850B	2 x BL1850B	2 x BL1850B	2 x BL1850B	2 x BL1850B
Slagenergie		1,2 J	1,7 J	2 J	1,7 J	1,7 J	2 J	2 J
Max. Ø beton		16 mm	16 mm	20 mm	18 mm	18 mm	24 mm	24 mm
BL-motor		✓	✓	-	✓	✓	✓	✓
AVT		-	✓	-	✓	✓	-	-
AWS		-	-	-	✓ excl. Bluetooth unit	✓ excl. Bluetooth unit	-	-
Stofafzuigingsysteem		-	DX16	-	-	DX05	-	DX07
Gewicht		2,1 kg	2,1 - 2,8 kg	3,5 kg	2,4 kg	3,3 kg	3,2 kg	4,7 kg
Prijs in €	excl. btw							
	incl. btw							

Technologie

AFT

Active feedback sensing technology

Deze technologie schakelt de motor onmiddellijk uit bij het plots blokkeren van de machine. Sommige machines maken daarbij gebruik van een accelerometer die de zwenkbeweging van de machine detecteert. De AFT-technologie verhoogt de veiligheid enorm.

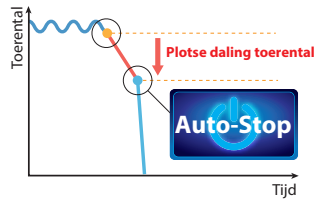

AVT

Anti-vibration technology

Het AVT-systeem reduceert trillingen drastisch door het gebruik van een systeem met bewegend tegengewicht, hetgeen het gebruikscomfort sterk verbetert.

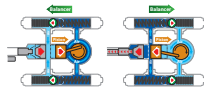

AWS

Auto-start Wireless System

Auto-start wireless system

Dankzij AWS wordt de stofafzuiging bij accu-toestellen automatisch geactiveerd d.m.v. een Bluetooth®-verbinding.



ACCU COMBIHAMERS SDS-PLUS



DHR283G2JU



DHR264PT2J

AWS AVT AFT

DHR283ZWJU
inclusief
STOFAFZUIGING



Alle modellen
INCLUSIEF extra
automatische
boorkop



	DHR264PT2J	DHR283ZJU	DHR283ZWJU	DHR283G2JU
Spanning	2 x 18V	2 x 18V	2x18V	2 x 18V
Bijgeleverde accu's	2 x BL1850B	0	0	2 x BL1860B
BL-motor	-	✓	✓	✓
Slagenergie	2,5 J	2,8 J	2,8 J	2,8 J
Max. Ø beton	26 mm	28 mm	28 mm	28 mm
AWS	-	✓	✓	✓
AVT	-	✓	✓	✓
AFT	-	✓	✓	✓
Stofafzuigstelsysteem	-	-	DX09	-
Gewicht	4,2 kg	4,0 kg	5,5 kg	4,0 kg
Prijs in €	excl. btw			
	incl. btw			

PREMIUM BEITELSET SDS-PLUS EN SDS-MAX

- ✓ 2 keer langere levensduur dan de standaard beitels!
- ✓ Zeer efficiënt: vormvast. Het afbraakwerk is veel productiever!

3-DELIGE PREMIUM BEITELSET SDS-PLUS

SDS- PLUS

E-20220

excl. btw

incl. btw



1 puntbeitel 250 mm
1 koudbeitel 20 x 250 mm
1 platte beitel 40 x 250 mm



AntiJam™ ontwerp

Verhoogt de productiviteit
Vermindert de wrijving en de kans op blokkeren
Speciaal ontworpen voor SDS-PLUS machines



5-DELIGE PREMIUM BEITELSET SDS-MAX

SDS- MAX

E-20236

excl. btw

incl. btw

NIEUW



2 puntbeitels 400 mm
2 koudbeitels 25 x 400 mm
1 platte beitel 780 mm



BreakPower™ ontwerp

Verhoogt de productiviteit
Vermindert de wrijving en de kans op blokkeren
Speciaal ontworpen voor SDS-MAX machines

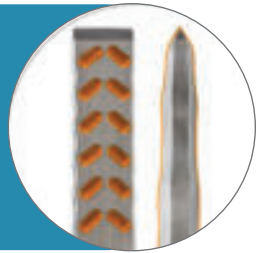

ACCU COMBIHAMER SDS-MAX

BL MOTOR AVT

AWS 18V + 18V → 36V



DHR400ZKU1
incl. stofafzuiging 199142-6

DHR400ZKUN DHR400ZKU1 DHR400G2UN

Spanning	2 x 18V	2 x 18V	2 x 18V
Bijgeleverde accu's	-	-	2 x BL1850B
Slagenergie	8 J	8 J	8 J
Max. Ø beton	40 mm	40 mm	40 mm
Vibratieniveau hamerboren	5,0 m/s ²	5,0 m/s ²	5,0 m/s ²
AWS	✓	✓	✓
AFT	✓	-	✓
Gewicht	8,1 kg	8,1 kg	8,1 kg
Prijs in €	excl. btw		
	incl. btw		

ACCU HETELUCHTPISTOLEN

18V LITHIUM-ION



DHG180RT1J



DHG181RT1J

DHG180RT1J DHG181RT1J

- Snelle wissel van het mondstuk
- Veilige schakelaar, te blokkeren in uit en aan stand
- Verschillende mondstukken zijn inbegrepen

Spanning	18V	18V
Bijgeleverde accu's	1x BL1850B	1x BL1850B
Temperatuurbereik	550 °C	6 standen, max 550 °C
Debiet	200 l/min	120 l/min, 200 l/min
Gewicht	1,0 - 1,3 kg	1,0 - 1,4 kg
Prijs in €	excl. btw	
	incl. btw	

ACCU SLAGMOERSLEUTELS



Auto-stop:
de machine stopt automatisch van zodra de bout of moer voldoende is losgedraaid

PROMO

gratis 87-delige gereedschapsset E-08458 bij DTW300RTJ

Wist je dat er van DTW300 de voordelige uitvoeringen DTW300Z en DTW300TJ bestaan? Zie p. 52-53 voor meer uitleg!



DTW1001RTJ



DTW190RTJ



DTW300RTJ



DTW700RTJ



DTW181RTJ

	DTW181RTJ	DTW190RTJ	DTW300RTJ	DTW700RTJ	DTW1001RTJ	DTW1002RTJ
Spanning	18V	18V	18V	18V	18V	18V
Bijgeleverde accu's	2 x BL1850B	2 x BL1850B	2 x BL1850B	2 x BL1850B	2 x BL1850B	2 x BL1850B
BL-motor	✓	-	✓	✓	✓	✓
XPT	✓	-	✓	✓	-	-
Toerental	0-2400 tpm.	0-2400 tpm.	0-3200 tpm.	0-2200 tpm.	0-1800 t.p.m.	0-1800 t.p.m.
Max. koppel	180 Nm	190 Nm	330 Nm	700 Nm	1050 Nm	1000 Nm
Dopaansluiting	1/2" vierkant	1/2" vierkant	1/2" vierkant	1/2" vierkant	3/4" vierkant	1/2" vierkant
Auto-stop functie	✓	-	✓	✓	-	-
Gewicht	1,2 kg	1,4 kg	1,8 kg	2,6 kg	3,4 kg	3,3 kg
Prijs in €	excl. btw					
	incl. btw					

ACCU RATELMOERSLEUTEL



Geleverd met 1/4" & 3/8" opname

Verwijderbare kop laat toe om 13 mm moeren over de lengte van een M8 draadstang te schroeven.



DWR180ZJ

	DWR180ZJ	DWR180RA1J
Spanning	18V	18V
Bijgeleverde accu's	0	1 x BL1820B
Toerental onbelast	0-800 t.p.m.	0-800 t.p.m.
Max. koppel	47,5 Nm	47,5 Nm
Gewicht	1,2 kg	1,2 kg
Prijs in €	excl. btw	
	incl. btw	

ACCU BREEKMOERSLEUTEL



- Voor het vastdraaien van torsiebreekbouten met een hoge trekvastheid (type HRC/tor-shear).
- Torsiebreekbouten worden vooral gebruikt bij industriële staalconstructies.

	DWT310ZK
Spanning	2x18V
Bijgeleverde accu's	-
Toerental onbelast	14 min ⁻¹
Max. koppel	804 Nm
Gewicht	6,5 - 7,1 kg
Prijs in €	excl. btw
	incl. btw



Impact PREMIER

ACCESSOIRES

IMPACT PREMIER

Duurzamer door de dubbele torsie!



E-13568
5-delige schroefbitset



Past zeer nauwkeurig in de schroef.

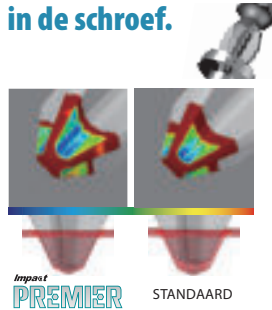

E-03567
11-delige schroefbitset



Gebruik van hoogwaardig staal. Ondersteunt een hoog koppel.

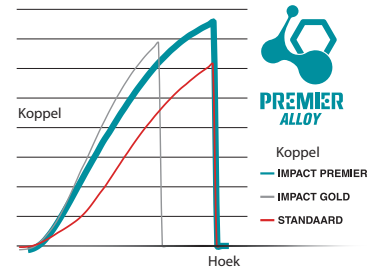

E-13552
31-delige schroefbitset



Excl. BTW / Incl. BTW

- E-03121 Schroefbit IMPACT PREMIER PH1-25 mm, 2 stks
- E-03137 Schroefbit IMPACT PREMIER PH2-25 mm, 2 stks
- E-03143 Schroefbit IMPACT PREMIER PH2(slim)-25 mm, 2 stks
- E-03159 Schroefbit IMPACT PREMIER PH3-25 mm, 2 stks
- E-03165 Schroefbit IMPACT PREMIER PZ1-25 mm, 2 stks
- E-03171 Schroefbit IMPACT PREMIER PZ2-25 mm, 2 stks
- E-03187 Schroefbit IMPACT PREMIER PZ3-25 mm, 2 stks
- E-03193 Schroefbit IMPACT PREMIER T10-25 mm, 2 stks
- E-03202 Schroefbit IMPACT PREMIER T15-25 mm, 2 stks
- E-03218 Schroefbit IMPACT PREMIER T20-25 mm, 2 stks
- E-03224 Schroefbit IMPACT PREMIER T25-25 mm, 2 stks
- E-03230 Schroefbit IMPACT PREMIER T30-25 mm, 2 stks
- E-20242 Schroefbit IMPACT PREMIER T40-25 mm, 2 stks
- E-03246 Schroefbit IMPACT PREMIER PH2-25 mm, 15 stks Flip top
- E-03252 Schroefbit IMPACT PREMIER PZ2-25 mm, 15 stks Flip top



- E-03268 Schroefbit IMPACT PREMIER PH1-50 mm, 2 stks
- E-03274 Schroefbit IMPACT PREMIER PH2-50 mm, 2 stks
- E-03280 Schroefbit IMPACT PREMIER PH3-50 mm, 2 stks
- E-03296 Schroefbit IMPACT PREMIER PZ1-50 mm, 2 stks
- E-03305 Schroefbit IMPACT PREMIER PZ2-50 mm, 2 stks
- E-03311 Schroefbit IMPACT PREMIER PZ3-50 mm, 2 stks
- E-03327 Schroefbit IMPACT PREMIER T10-50 mm, 2 stks
- E-03333 Schroefbit IMPACT PREMIER T15-50 mm, 2 stks
- E-03349 Schroefbit IMPACT PREMIER T20-50 mm, 2 stks
- E-03355 Schroefbit IMPACT PREMIER T25-50 mm, 2 stks
- E-03361 Schroefbit IMPACT PREMIER T30-50 mm, 2 stks
- E-12027 Schroefbit IMPACT PREMIER T40-50 mm, 2 stks
- E-03377 Schroefbit IMPACT PREMIER PH2-50 mm, 10 stks Flip top
- E-03383 Schroefbit IMPACT PREMIER PZ2-50 mm, 10 stks Flip top

Excl. BTW / Incl. BTW

- E-06286 Dubbelbit IMPACT PREMIER PH2-65 mm, 2 stks
- E-06292 Dubbelbit IMPACT PREMIER PZ2-65 mm, 2 stks



- E-03399 IMPACT PREMIER Torsion bithouder 68 mm
- E-03408 IMPACT PREMIER Torsion bithouder 150 mm

- E-03414 ULTRA MAG bithouder IMPACT PREMIER TORSION

- E-03420 IMPACT PREMIER Tilt adapter 1/4" voor krachtdoppen 3/8" - 50 mm
- E-03436 IMPACT PREMIER Tilt adapter 1/4" voor krachtdoppen 1/2" - 50 mm

- E-03442 IMPACT PREMIER Mag Boost magneet voor schroefbits

- E-03458 IMPACT PREMIER Torsion dopsleutel H6-65 mm
- E-03464 IMPACT PREMIER Torsion dopsleutel H8-65 mm
- E-03470 IMPACT PREMIER Torsion dopsleutel H10-65 mm
- E-03486 IMPACT PREMIER Torsion dopsleutel H13-65 mm

- E-03492 IMPACT PREMIER krachtdop H13-80 mm
- E-03501 IMPACT PREMIER krachtdop H15-80 mm
- E-03517 IMPACT PREMIER krachtdop H17-80 mm
- E-03523 IMPACT PREMIER krachtdop H19-80 mm
- E-03539 IMPACT PREMIER krachtdop H21-80 mm

- E-03573 11-delige IMPACT PREMIER schroefbitset



ACCU HAAKSE
SLAGSCHROEVENDRAAIER



DTL061RTJ

Spanning	18 V
Bijgeleverde accu's	2 x BL1850B
Toerental	0-2000 t.p.m.
Gewicht	1,8 kg
Prijs in €	excl. btw
	incl. btw

ACCU SLAGSCHROEVENDRAAIERS



Assist mode: voor het vlot aanzetten bij het schroeven.

T-modus: instelling voor zelftappende schroeven.



DTD157RTJ



DTD153RTJ



DTD172RTJ

PROMO

gratis
neusadapter
194281-7 bij
DTD153RTJ



Wist je dat er van DTD153 de voordelige uitvoeringen DTD153Z en DTD153T1J bestaan? Zie p. 52-53 voor meer info!

	DTD156RTJ	DTD153RTJ	DTD157RTJ	DTD154RTJ	DTD172RTJ
Spanning	18 V	18 V	18 V	18 V	18 V
Bijgeleverde accu's	2 x BL1850B	2 x BL1850B	2 x BL1850B	2 x BL1850B	2 x BL1850B
BL-motor	-	✓	✓	✓	✓
Toerental	0-2500 t.p.m.	0-3400 t.p.m.	0-3000 t.p.m.	0-3600 t.p.m.	0-3600 t.p.m.
Max. koppel	155 Nm	170 Nm	140 Nm	175 Nm	180 Nm
Bitopname	1/4" hex.	1/4" hex.	1/4" hex.	1/4" hex.	1/4" hex.
Slagkrachtniveau	-	-	2	3	4
T-modus	-	-	-	✓	✓
Assist mode	-	-	✓	-	✓
Gewicht	1,3 kg	1,5 kg	1,2 kg	1,5 kg	1,5 kg
Prijs in €	excl. btw				
	incl. btw				

ACCU HYBRIDE
BOOR- EN SCHROEFMACHINE



DTP141RTJ

4 modi: klopboren, boren schroeven, slagschroeven

	DTP141ZJ	DTP141RTJ
Spanning	18 V	18 V
Bijgeleverde accu's	-	2 x BL1850B
Toerental	0-2700 t.p.m.	0-2700 t.p.m.
Gewicht	1,8 kg	1,8 kg
Prijs in €	excl. btw	
	incl. btw	

ACCU HYDRAULISCHE
SLAGSCHROEVENDRAAIER



DTS141ZJ

Uiterst stil dankzij het unieke hydraulische impulssysteem

	DTS141ZJ
Spanning	18 V
Bijgeleverde accu's	-
Toerental	0-3200 t.p.m.
Max. koppel	40 Nm
Bitopname	1/4" hex
T-modus	✓
Gewicht	1,5 kg
Prijs in €	excl. btw
	incl. btw

ACCU PINPISTOOL
23 Ga



DPT353RTJ

Spanning	18 V
Bijgeleverde accu's	2 x BL1850B
Doorsnede nagel	0,6 mm
Lengte nagel	15-35 mm
Gewicht	2,0 kg
Prijs in €	excl. btw
	incl. btw

ACCU NIETMACHINES



DST221RTJ

DST221:
Aluminium magazijn

DST112RTJ DST221RTJ

Spanning	18 V	18 V
Bijgeleverde accu's	2 x BL1850B	2 x BL1850B
Rugbreedte niet	10 mm	10,5 mm
Lengte niet	7-10 mm	10-22 mm
Gewicht	1,5 kg	2,1 kg
Prijs in €	excl. btw	
	incl. btw	

ACCU MINIBRADPISTOLEN
18 Ga



DFN350RTJ



DBN500RTJ

DFN350RTJ DBN500RTJ

Spanning	18 V	18 V
Bijgeleverde accu's	2 x BL1850B	2 x BL1850B
Doorsnede nagel	1,2 mm	1,2 mm
XPT	✓	-
Lengte nagel	15-35 mm	15-50 mm
Gewicht	2,1 kg	3,2 kg
Prijs in €	excl. btw	
	incl. btw	

Voor zacht hout

ACCU BRADPISTOOL
16 Ga



Voor zacht hout

DBN600RTJ

Spanning	18 V
Bijgeleverde accu's	2 x BL1850B
Doorsnede nagel	1,6 mm
Lengte nagel	25-64 mm
Gewicht	3,4 kg
Prijs in €	excl. btw
	incl. btw

ACCU LAMELLENFREES

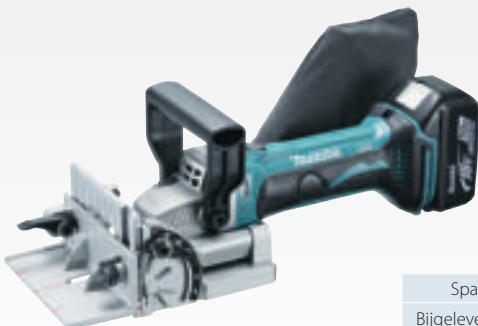

DPJ180RTJ

Spanning	18 V
Bijgeleverde accu's	2 x BL1850B
Toerental	6500 t.p.m.
Gewicht	3,2 kg
Prijs in €	excl. btw
	incl. btw

ACCU SCHAAF



DKP181RTJU



DKP181RTJU

Spanning	18 V
Bijgeleverde accu's	2 x BL1850B
Toerental	12000 t.p.m.
Schaafbreedte	82 mm
Max. spaanafname	3 mm
Sponningdiepte	25 mm
AWS	✓
Gewicht	3,3 kg
Prijs in €	excl. btw
	incl. btw

ACCU RECIPROZAGEN



DJR189

- Kan met één hand gebruikt worden
- Uitstekend geschikt voor het zagen in nauwe ruimten en in de hoogte
- Uitermate licht en toch zeer krachtig
- Trillingsarm (anti-vibratiesysteem met bewegend tegengewicht)

	DJR189ZJ	DJR183RTJ	DJR186RTE	DJR187RTE	DJR188RTJ	DJR360PT2
Spanning	18V	18V	18V	18V	18V	2 x 18V
Bijgeleverde accu's	-	2 x BL1850B	2 x BL1850B	2 x BL1850B	2 x BL1850B	2 x BL1850B
Bijgeleverde lader	-	DC18RC	DC18RC	DC18RC	DC18RC	DC18RD
BL-motor	✓	-	-	✓	✓	✓
Toerental	0-3100 /min	0-3300 /min	0-2800 /min	0-3000 /min	0-3000 /min	0-3000 /min
Slaglengthe	22 mm	13 mm	32 mm	32 mm	20 mm	32 mm
Max. capaciteit hout	255 mm	50 mm	255 mm	255 mm	255 mm	255 mm
Gewicht	2,2 - 2,5 kg	1,6 kg	3,5 kg	3,4 kg	2,9 kg	4,6 kg
Prijs in €	excl. btw					
	incl. btw					

ACCU DECOUPEERZAGEN



Wist je dat er van DJV181 en DJ182 de voordelige uitvoeringen DJV181Z / DJV181T1J en DJV182Z / DJV182T1J bestaan? Zie p. 52-53 voor meer info!

	DJV184RTJ	DJV185RTJ	DJV181RTJ	DJV182RTJ
Spanning	18V	18V	18V	18V
Bijgeleverde accu's	2 x BL1850B	2 x BL1850B	2 x BL1850B	2 x BL1850B
BL motor	✓	✓	✓	✓
Aantal zaagbewegingen	0-3000 min ⁻¹	800-3000 min ⁻¹	800-3500 min ⁻¹	800-3500 min ⁻¹
Max. capaciteit hout	135 mm	135 mm	135 mm	135 mm
Slaglengthe	23 mm	23 mm	26 mm	26 mm
Gewicht	2,1 - 2,4 kg	2,0 - 2,3 kg	2,3 - 2,6 kg	2,4 - 2,7 kg
Prijs in €	excl. btw			
	incl. btw			

ACCU INVALCIRKELZAGEN
165 mm

18v → 36v



Geleiderail
194368-5 bij PT2J1



DSP600PT2J1

DSP601ZJU DSP600PT2J DSP600PT2J1

Spanning	2 x 18 V	2 x 18 V	2 x 18 V
Bijgeleverde accu's	0	2 x BL1850B	2 x BL1850B
Zaagdiepte	56 mm	56 mm	56 mm
Diameter asgat	20 mm	20 mm	20 mm
AWS	✓	-	-
Aantal MAKPAC-koffers	1	2	2
Gewicht	4,4 kg	4,4 kg	4,4 kg
Prijs in €	excl. btw		
	incl. btw		

ACCU METAALCIRKELZAGEN



18v
LITHIUM-ION



DCS552RTJ

DCS553RTJ

DCS552RTJ DCS553RTJ

Spanning	18 V	18 V
Bijgeleverde accu's	2 x BL1850B	2 x BL1850B
BL-motor	-	✓
Ø zaagblad	136 mm	150 mm
Zaagdiepte (90°)	50,5 mm	57,5 mm
Gewicht	2,4 kg	3,0 kg
Prijs in €	excl. btw	
	incl. btw	

COMBOPACK



DSP600

BL1850B

DJV182

DC18RD

DLX2234PX1

Invalcirkelzaag	DSP600
Bijgeleverde accu's	2 x BL1850B
Decoupeerzaag	DJV182
Lader	DC18RD
Prijs in €	excl. btw
	incl. btw

ACCU CIRKELZAGEN



18v → 36v

18v
LITHIUM-ION



DHS782PT2J

DHS680RTJ

DHS660RTJ

Promo DHS680RTJ:
gratis 3e BL1850B



Wist je dat er van DHS680 de voordelige uitvoeringen DHS680Z en DHS680T1J bestaan? Zie p. 52-53 voor meer info!

DHS782, DHS783 & DHS900
passen rechtstreeks op geleiderail

	DSS501RTJ	DHS680RTJ	DHS660RTJ	DHS661RTJU	DHS630RTJ	DHS710PT2J	DHS782PT2J	DHS783T2JU	DHS900PT2	DHS900PT2U
Spanning	18 V	18 V	18 V	18 V	18 V	2 x 18 V	2 x 18 V	2 x 18 V	2 x 18 V	2 x 18 V
Bijgeleverde accu's	2 x BL1850B	2 x BL1850B	2 x BL1850B	2 x BL1850B	2 x BL1850B	2 x BL1850B	2 x BL1850B	2 x BL1850B	2 x BL1850B	2 x BL1850B
BL-motor	✓	✓	✓	✓	-	-	✓	✓	✓	✓
Zaagdiepte (90°)	51 mm	57 mm	57 mm	57 mm	66 mm	68,5 mm	62,5 mm	62,5 mm	85 mm	85 mm
Ø zaagblad	136 mm	165 mm	165 mm	165 mm	165 mm	190 mm	190 mm	190 mm	235 mm	235 mm
AWS	-	-	-	✓	-	-	-	✓	✓	✓
Gewicht	2,7 kg	3,3 kg	3,4 kg	3,4 kg	3,5 kg	4,7 kg	4,5 kg	4,5 kg	5,3 kg	5,3 kg
Prijs in €	excl. btw									
	incl. btw									

excl. Bluetooth unit

ACCU AFKORT-VERSTEKZAAG



DLS600RTE



Spanning	18 V
Bijgeleverde accu's	2 x BL1850B
Ø zaagblad	165 mm
Max. zaagcapaciteit bij 90°	46 x 92 mm
Gewicht	6,6 kg
Prijs in €	excl. btw
	incl. btw

EFFICUT

Fijner, sneller en efficiënter snijden



Scan mij voor meer info!



Meer zaagsneden per batterijlading



Snel zagen



Langere levensduur



Zuivere zaagsnede



ACCU TELESCOPISCHE AFKORT-VERSTEKZAGEN



DXT

Deep and Exact Cutting Technology

De gepatenteerde constructie met drevoudige tandwieloverbrenging en uitsparing achter de flens laat toe om een groter deel van het zaagblad te benutten. Daardoor kunnen ook hoge plinten verticaal of in verstek afgekort worden.



DLS714NPT2 DLS111ZU DLS211ZU

Spanning	2 x 18 V	2 x 18 V	2 x 18 V
Bijgeleverde accu's	2 x BL1850B	promo: B-67290	promo: B-67315
Ø Zaagblad	190 mm	260 mm	305 mm
Zaagdiepte (90°)	52 mm	91 mm	107 mm
Zaagbreedte (90°)	300 mm	310 mm	363 mm
DXT	-	✓	✓
AWS	-	✓	✓
Gewicht	13,0 kg	27,3 kg	30,7 kg
Prijs in €	excl. btw		
	incl. btw		

ACCU MENGER



Ideaal voor het mengen van vloeistoffen, verf en lichte lijmsorten.

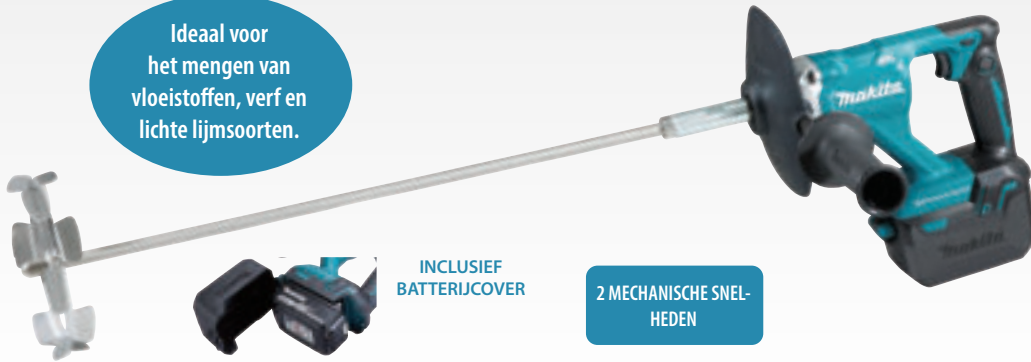

INCLUSIEF BATTERIJCOVER

2 MECHANISCHE SNELHEDEN

DUT130RTE

Spanning	18 V
Bijgeleverde accu's	2 x BL1850B
Diameter mengblad	165 mm
Aansluiting	M12-M14
Toerental	0-350 / 0-1300 t.p.m.
Gewicht	2,5 kg
Prijs in €	excl. btw
	incl. btw

ACCU LANGNEKSCHUURMACHINE 225 MM



Accessoires

Steunschijf

Type	Ref.	Prijs excl. btw	Prijs incl. btw
Zacht	199939-3		
Medium	199940-8		
Hard	199938-5		

Schuurschijf 225 mm (per 25)

Korrel	Ref.	Prijs excl. btw	Prijs incl. btw
P40	B-68389		
P80	B-68395		
P120	B-68404		
P180	B-68410		
P320	B-68426		



Telescopische buis
De totale lengte van de machine kan aangepast worden van 1100 tot 1520 mm



Verlengstuk
Met het optionele verlengstuk met steun (199937-7) kan langer comfortabel in de hoogte gewerkt worden.



DSL801RTEU

DSL800ZU



De beschermkap van de DSL800 heeft één rechte kant, dat laat toe dicht langs een muur of plafond te bewegen.



De beschermkap van de DSL801 is volledig rond, dit is gunstig voor de stofafvoer.

DSL800ZU DSL801ZU

Spanning	18 V	18 V
Bijgeleverde accu's	0	0
AWS	✓	✓
Toerental onbelast	1000-1800 t.p.m.	1000-1800 t.p.m.
Diameter schuurschijf	225 mm	225 mm
Lengte	1100 -1520 mm	1100 -1520 mm
Gewicht	4,8 kg	4,8 kg
Prijs in €	excl. btw	
	incl. btw	

ACCU GIPSFREES



DCO181Z

Spanning	18 V
Bijgeleverde accu's	0
Toerental	0 - 32000 t.p.m.
AWS	✓ excl. Bluetooth unit
BL-Motor	✓
Gewicht	1,4 kg
Prijs in €	excl. btw
	incl. btw

ACCU GIPSAZAG



DSD180ZJ

Spanning	18 V
Bijgeleverde accu's	0
Slaglengte	6 mm
Gewicht	1,7 kg
Prijs in €	excl. btw
	incl. btw

ACCU SCHROEFAUTOMATEN



• **"Push Drive"-technologie:** de motor start automatisch wanneer de neus van de machine tegen de ondergrond wordt gedrukt.



DFR551RTJ



DFR550RTJ

	DFR550RTJ	DFR750Z	DFR452RTJ	DFR551RTJ
Spanning	18V	18V	18V	18V
Bijgeleverde accu's	2xBL1850B	0	2xBL1850B	2xBL1850B
Toerental	4000 t.p.m.	4000 t.p.m.	6000 t.p.m.	6000 t.p.m.
BL motor	-	-	✓	✓
Ø Gipsplaatschroef	4,0 mm	4,0 mm	3,5-4,2 mm	3,5-4,2 mm
Schroeflengte	25-55 mm	45-75 mm	20-41 mm	25-55 mm
"Push drive" technologie	-	-	✓	✓
Gewicht	2,1 kg	2,1 kg	2,2 kg	2,2 kg
Prijs in €	excl. btw			
	incl. btw			

ACCU SCHROEVENDRAAIERS



Duw-aandraaistand ("Push drive")



In de duw-aandraaistand gaan de motor en de schroefkop automatisch draaien wanneer er druk op wordt uitgeoefend.



DFS250RTJ



DFS452FJX2

	DFS250RTJ	DFS452RAJ	DFS452FJX2
Spanning	18 V	18 V	18 V
Bijgeleverde accu's	2 x BL1850B	2 x BL1820B	2 x BL1830B
Toerental	0-2500 t.p.m.	0-4000 t.p.m.	0-4000 t.p.m.
Incl. schroeflintadapter	-	-	✓
Schroeflengte	-	-	25-55 mm
"Push drive" technologie	-	✓	✓
Gewicht	1,5 kg	1,5 kg	1,5 kg
Prijs in €	excl. btw		
	incl. btw		

ACCU BOVEN- EN KANTENFREES



	DRT50ZJX3	DRT50RTJX3
Spanning	18 V	18 V
Bijgeleverde accu's	0	2 x BL1850B
Max. induikdiepte	35 mm	35 mm
Toerental onbelast	10.000-30.000 t.p.m.	10.000-30.000 t.p.m.
Ø spantang - bereik	6 - 8 mm	6 - 8 mm
Ø spantang - inbegrepen	6 mm, 8 mm	6 mm, 8 mm
Gewicht	2,1 kg	2,1 kg
Prijs in €	excl. btw	
	incl. btw	

ACCU HANDPALMVLAKSCHUURMACHINES



DBO480: standaard met extra driehoekszool

Promo
DBO480RTJ, DBO481RTJ
en DBO482RTJ:
gratis extra accu BL1830B

NIEUW

	DBO480RTJ	DBO481RTJ	DBO482RTJ	DBO484ZJ
Spanning	18 V	18 V	18 V	18 V
Bijgeleverde accu's	2x BL1850B	2x BL1850B	2x BL1850B	-
Afmetingen schuurvoet	112 mm x 102 mm	112 mm x 102 mm	112 mm x 102 mm	112 mm x 102 mm
Papierbevestiging	Klem/Velcro	Klem	Klem	Klem/Velcro
Materiaal schuurvoet	Kunststof	Kunststof	Aluminium	Aluminium
Aantal schuurbewegingen	22000/28000 min ⁻¹	22000/28000 min ⁻¹	22000/28000 min ⁻¹	22000/28000 min ⁻¹
Schuuruitslag	1,5 mm	1,5 mm	1,5 mm	1,5 mm
AWS ready	-	-	✓	✓
Gewicht	1,4-1,8 kg	1,4-1,8 kg	1,4-1,8 kg	1,4-1,8 kg
Prijs in €	excl. btw			
	incl. btw			

ACCU VLAKSCHUURMACHINES



DBO381RTJU

DBO382ZJ

NIEUW

	DBO380RTJ	DBO381RTJU	DBO382ZJ
Spanning	18 V	18 V	18 V
Bijgeleverde accu's	2x BL1850B	2x BL1850B	2x BL1850B
Afmetingen schuurvoet	92 mm x 185 mm	92 mm x 185 mm	92 mm x 185 mm
Papierbevestiging	Klem	Klem	Klem/velcro
Materiaal schuurvoet	Aluminium	Aluminium	Aluminium
Aantal schuurbewegingen	8000/16000/24000 min ⁻¹	8000/16000/24000 min ⁻¹	8000/16000/24000 min ⁻¹
Schuuruitslag	2,0 mm	2,0 mm	2,0 mm
AWS	-	✓	-
Gewicht	1,9 - 2,2 kg	1,9 - 2,2 kg	1,9 - 2,2 kg
Prijs in €	excl. btw		
	incl. btw		

ACCU EXCENTRISCHE SCHUURMACHINE 125 MM



DBO180

DBO180RTJ

Spanning	18 V
Bijgeleverde accu's	2 x BL1850B
Diameter schuurvoet	125 mm
Aantal schuurbewegingen	14000 - 22000 mm ⁻¹
Schuuruitslag	2,8 mm
Gewicht	1,7 kg
Prijs in €	excl. btw
	incl. btw

ACCU EXCENTRISCHE POLIJSTMACHINES



DPO500Z

Vrije rotatie en
geforceerde rotatie

	DPO500Z	DPO600Z
Spanning	18 V	18 V
Bijgeleverde accu's	0	0
Oscillatiefrequentie	0-13600 min ⁻¹	0-13600 min ⁻¹
Schuurvoet	125 mm	150 mm
Schuuruitslag	5,5 mm	5,5 mm
Gewicht	3,1 kg	3,1 kg
Prijs in €	excl. btw	
	incl. btw	

ACCU BANDSCHUURMACHINE 9 MM



Hoog gebruikskomfort en perfecte balans door centrale plaatsing van de motor

Richtbare led en zijhandgreep



Werkbereik 90°
(met uiterste stand 160°
voor het opbergen)

DBS180RTJ

Spanning	18 V
Bijgeleverde accu's	2 x BL1850B
Bandsnelheid	600 - 1700 m/min
Schuurband	9 x 533 mm
Gewicht	1,8 - 2,1 kg
Prijs in €	excl. btw
	incl. btw

ACCU MULTITOOL

Wist je dat er van DTM51 de voordelige uitvoeringen DTM51Z en DTM51T1JX2 bestaan? Zie p. 52-53 voor meer info!



STARLOCK



Gereedschapsloze accessoirewissel

DTM51RTJX2

STARLOCK STARLOCK PLUS STARLOCK MAX



DTM52
incl. accessoires

DTM51

- Compatibel met OIS en Starlock (niet met Starlock Plus en Starlock Max).

Inclusief: set van 9 accessoires, 30 schuurvellen, 1 afzuigset

DTM52

- Compatibel met Starlock, Starlock Plus en Starlock Max accessoires, ideaal voor de zwaardere toepassingen.
- Grote oscillatiehoek van 1,8° links/rechts
- Zeer lage trillingswaarden dankzij AVT technologie
- Kleine greepomtrek en laag gewicht

	DTM51RTJX2	DTM52RTJX1
Spanning	18 V	18 V
Bijgeleverde accu's	2 x BL1850B	2 x BL1850B
BL motor	-	✓
Oscillatiefrequentie	6000-20000 /min	10000-20000 /min
Oscillatiehoek	3,2°	3,6°
Opname	OIS, Starlock	Starlock, Starlock Plus, Starlock Max
Gewicht	2,0 kg	1,7 kg
Prijs in €	excl. btw	
	incl. btw	

STARLOCK



STARLOCK PLUS



STARLOCK MAX



Voor het totaal overzicht van het assortiment scan hier

- ✓ Snelle wissel van accessoires door een simpele klik
- ✓ Starlock Plus zaagbladen : snel, diep en veelzijdig invallend zagen
- ✓ Starlock Max zaagbladen : zelfs voor de meest veeleisende en zware toepassingen

Starlock Plus en Starlock Max accessoires kunnen enkel gebruikt worden met de DTM52.

ACCU SCHUURPOLIJSTMACHINE 75 MM



Polijsten
Steunschijf met velcro opname voor polijst toepassingen.



Compact
Uiterst compacte machine met de handgreep kort bij de schijf voor een optimale controle.

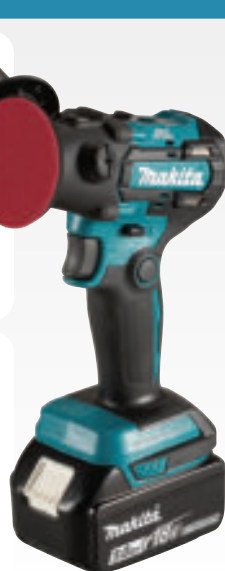

DPV300RTJ

- Zeer compacte machine ideaal voor het schuren en polijsten van kleine oppervlakken.
- Twee mechanische versnellingen en traploze snelheidsregeling.
- Geleverd met velcro steunschijf voor het polijsten en een Roloc™ opname voor schuurtoepassingen.



Schuren
Roloc™ compatibele opname voor schuurtoepassingen.

● Accessoires

Steunschijf

Referentie	Omschrijving
E-07412	Schuurschijf aluminiumoxide 50 mm A60 (25 st.)
E-07428	Schuurschijf aluminiumoxide 50 mm A80 (25 st.)
E-07434	Schuurschijf aluminiumoxide 50 mm A120 (25 st.)
E-07440	Schuurschijf zirconium 50 mm Z60 (25 st.)
E-07456	Schuurschijf zirconium 50 mm Z80 (25 st.)
E-07462	Vliesschijf zirconium Grof / Hard 50 mm (25 st.)
E-07478	Vliesschijf zirconium Medium / Hard 50 mm (25 st.)
E-07484	Vliesschijf zirconium Fijn / Hard 50 mm (25 st.)
E-07490	Vliesschijf zirconium Medium/ Zacht 50 mm (25 st.)
E-07509	Vliesschijf zirconium Fijn/Zacht 50 mm (25 st.)
E-07515	Vliesschijf zirconium Zeer fijn/ Zacht 50 mm (25 st.)

Prijs excl. btw Prijs incl. btw

		DPV300RTJ
Bijgeleverde accu's		2 x BL1850
Capaciteit polijsten		80 mm
Capaciteit schuren		50 mm
Toerental polijsten		0-2800 min ⁻¹
Toerental schuren		0-9500 min ⁻¹
Gewicht		1,3 kg
Prijs in €	excl. btw	
	incl. btw	

ACCU BANDZAGEN

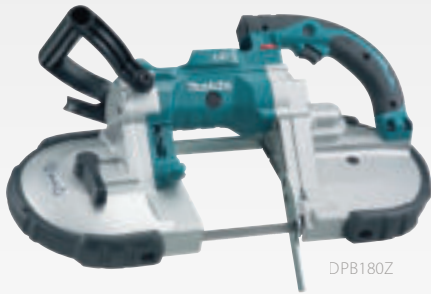

DPB180Z

Aluminium
behuizing



DPB183Z



DPB184Z

	DPB180Z	DPB184Z	DPB183Z
Spanning	18 V	18 V	18 V
Bijgeleverde accu's	-	-	-
Bijgeleverde lader	-	-	-
Max. bandsnelheid	162 m/min	192 m/min	192 m/min
Capaciteit stalen buis	120 x 120 mm	51 x 51 mm	66 x 66 mm
BL-motor	-	✓	✓
Gewicht	6,8 kg	3,2 kg	3,8 kg
Prijs in €	excl. btw		
	incl. btw		

ACCU METAALAFKORTMACHINE



DLW140PG2

Gereedschapsloze (hoek)-
verstelling van de geleider.

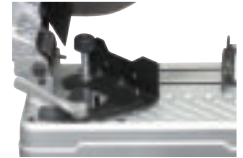

	DLW140Z	DLW140PG2
Spanning	2 x 18 V	2 x 18 V
Bijgeleverde accu's	0	2 x BL1860B
Toerental onbelast	3800 t.p.m.	3800 t.p.m.
Diameter schijf	355 mm	355 mm
Gewicht	16,9 kg	16,9 kg
Prijs in €	excl. btw	
	incl. btw	

ACCU BLINDKLINKNAGELPISTOLEN



DRV150Z



Scan deze code
voor uitgebreide
technische info.

	DRV150Z	DRV250Z
Bijgeleverde accu's/lader	-	-
Trekkraft	10 kN	20 kN
Compatibel met blindklinknagel Ø	24/32/40/48mm	48/60/64mm
Slaglengthe	25 mm	30 mm
Gewicht	1,9 kg	2,1 kg
Prijs in €	excl. btw	
	incl. btw	

ACCU AFKORTSLIJPMACHINES

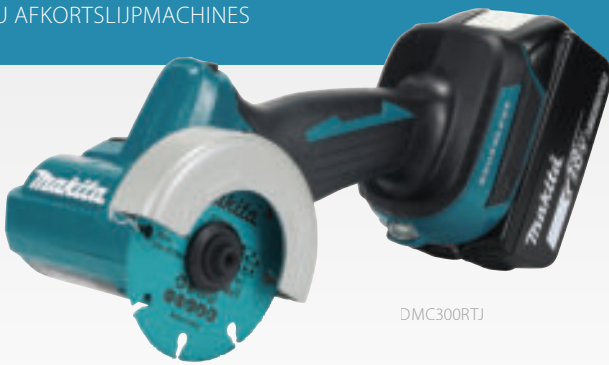

DMC300RTJ

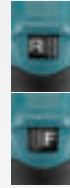

DMC300

- Zeer compacte slijpmachine, ideaal voor het zagen op moeilijk bereikbare plaatsen
- Goed uitgebalanceerd, kan veilig met één hand gebruikt worden
- De draairichting is omkeerbaar
- Stofkap met aansluiting voor stofafzuiging standaard bijgeleverd
- Voor het zagen in staal, keramiek en kunststoffen



D-74815-5 D-77263 D-74837

Accessoires

Ref	Type	Prijs excl. btw	Prijs incl. btw
D-74815-5	Doorslijpschijf voor RVS 76mm (5 stuks)		
D-77263	Diamantschijf 76x1,4x10mm		
D-74837	Carbide multi-snijschijf 76x10mm		

NIEUW

DMC300ZJ

NIEUW

DMC300RTJ

Spanning	18 V	18 V
Bijgeleverde accu's	-	2x BL1850B
Lader	-	DC18RC
Ø schijf	76 mm	76 mm
Toerental onbelast	20000 min ⁻¹	20000 min ⁻¹
Max. zaagdiepte	met stofkap: 13,5 mm zonder stofkap: 16,0 mm	met stofkap: 13,5 mm zonder stofkap: 16,0 mm
Gewicht	1,2 - 1,7 kg	1,2 - 1,7 kg
Prijs in €	excl. btw	
	incl. btw	

ACCU DOORSLIJPER



DCE090T2X1

Maximale zaagdiepte 88 mm

Promo
DCE090ZK1 en DCE090T2X1:
gratis 25 doorslijpschijven RVS



Accessoires

Ref	Type	Prijs excl. btw	Prijs incl. btw
E-03006-25	Doorslijpschijf RVS (25 st.) 230 x 2,0 x 22,23 mm		
E-02967	Diamantschijf 230 mm x 2,4 x 22,23 mm		

De gesegmenteerde diamantschijf E-02967 werd speciaal ontwikkeld voor het gebruik met een accu doorslijper. De diamantkorrels zijn gelijkmatig verdeeld en volgens een speciaal V-vormig patroon ingebed. Daardoor blijft de schijf continu scherp en zijn de zaagprestaties optimaal.



	DCE090ZK1	DCE090T2X1
Spanning	2 x 18 V	2 x 18 V
Bijgeleverde accu's	0	2 x BL1850B
Lader	-	DC18RD
Ø schijf	230 mm	230 mm
Toerental onbelast	6600 min ⁻¹	6600 min ⁻¹
Max. zaagdiepte	88 mm	88 mm
Max. schijfdikte	3,0 mm	3,0 mm
Gewicht	5,6 - 6,3 kg	5,6 - 6,3 kg
Prijs in €	excl. btw	
	incl. btw	

ACCU DIAMANTZAAG 125 MM



Inclusief 2 stofkappen, voor droog en nat gebruik

Ideaal voor afwerking (steen, beton, keramiek)

Kantelbaar tot 45°

	DCC501RTJ
Spanning	18 V
Toerental onbelast	8500 min ⁻¹
AWS	✓ excl. Bluetooth unit
Diameter asgat	20 mm
Bijgeleverde accu's	2 x BL1850B
Gewicht	2,7 kg
Prijs in €	excl. btw
	incl. btw

ACCU HAAKSE SLIJERS 125 MM

ADT AFT **BL MOTOR**

Wist je dat er van DGA506 en DGA508 de voordelige uitvoeringen DGA506Z / DGA506T1J en DGA508Z / DGA508T1J bestaan? Zie p. 52-53 voor meer info!

Promo
DGA506T1J en DGA508T1J:
gratis 10 doorslijpschijven
D-18770-10

18V LITHIUM-ION **MAX PAC**

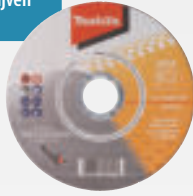

Promo
DGA506RTJ en DGA508RTJ:
gratis extra accu BL1830B

	DGA506RTJ	DGA508RTJ	DGA513RTJ	DGA514RTJU	DGA517RTJ	DGA518RTJU
Spanning	18V	18V	18V	18V	18V	18V
Bijgeleverde accu's	2 x BL1850B	2 x BL1850B	2 x BL1850B	2 x BL1850B	2 x BL1850B	2 x BL1850B
Ø schijf	125 mm	125 mm	125 mm	125 mm	125 mm	125 mm
Heropstartbeveiliging	✓	✓	✓	✓	✓	✓
Elektrische rem	✓	✓	✓	✓	✓	✓
Regelbaar toerental	-	-	✓	✓	✓	✓
AWS	-	-	-	✓	-	✓
Schakelaar	Schuifschakelaar met vergrendeling	Lepeschakelaar, zonder vergrendeling	Schuifschakelaar met vergrendeling	Schuifschakelaar met vergrendeling	Lepeschakelaar, zonder vergrendeling	Lepeschakelaar, zonder vergrendeling
Gewicht	2,5 kg	2,5 kg	2,5 kg	2,5 kg	2,5 kg	2,5 kg
Prijs in €	excl. btw					
	incl. btw					

BESCHERMKAP MET STOFAFZUIGING VOOR HAAKSE SLIJERS



	196845-3	198440-5
Diameter stofkap	125 mm	230 mm
Max. zaagdiepte	20 mm	60 mm
Prijs in €	excl. btw	
	incl. btw	

ACCU STEPELSLIJPER



DGD800RTJ

Spanning	18V
Bijgeleverde accu's	2 x BL1850B
Toerental	25000 t.p.m.
Ø spantang - bereik	6 - 8 mm
Ø spantang - inbegrepen	6 mm
Gewicht	2,1 kg
Prijs in €	excl. btw
	incl. btw

ACCU HAAKSE SLIJERS 180-230 MM

ADT AFT **18V + 18V** **36V**



DGA900PG2

DGA701ZKU

	DGA701ZKU	DGA900ZK	DGA900PG2	DGA901ZKU	DGA901PG2U
Spanning	2 x 18V	2 x 18V	2 x 18V	2 x 18V	2 x 18V
Bijgeleverde accu's	0	0	2 x BL1860B	0	2 x BL1860B
Ø schijf	180 mm	230 mm	230 mm	230 mm	230 mm
AWS	✓	-	-	✓	✓
Gewicht	5,0 kg	5,2 kg	5,2 kg	5,2 kg	5,2 kg
Prijs in €	excl. btw				
	incl. btw				

ACCU HAAKSE SLIJPER 125 MM X-LOCK



	DGA521ZX1	DGA520ZX1	DGA519ZJ	DGA519RTJ
Spanning	18 V	18 V	18 V	18 V
Bijgeleverde accu's	0	0	0	2 x BL1850B
Ø schijf	125 mm	125 mm	125 mm	125 mm
Toerental onbelast	8500 min ⁻¹	8500 min ⁻¹	3000 - 8500 t.p.m.	3000 - 8500 t.p.m.
Heropstartbeveiliging	✓	✓	✓	✓
Elektrische rem	-	✓	✓	✓
Regelbaar toerental	-	-	✓	✓
Type schakelaar	Schuifschakelaar met vergrendeling	Lepelschakelaar zonder vergrendeling	Lepelschakelaar zonder vergrendeling	Lepelschakelaar zonder vergrendeling
Gewicht	2,4 - 3,0 kg	2,4 - 3,0 kg	2,5 kg	2,5 kg
Prijs in €	excl. btw			
	incl. btw			



Snel en veilig schijven bevestigen via een kliksysteem.



ACCESSOIRES X-LOCK

Referentie	Type	Prijs excl. btw	Prijs incl. btw
E-00393	Afbraamschijf voor metaal 125 mm x 6 x 22,23		
E-00402	Afbraamschijf voor inox 125 mm x 6 x 22,23		
E-00418	Doorslijpschijf voor inox 125 mm x 1,2 x 22,23		
E-02076	Diamantdoorslijpschijf 125 mm		
191G05-4	Beschermkap met stofafzuiging 125 mm		
D-73396	Komborstel voor metaal, gegolfde draad 75 mm x 0,3		
D-73433	Komborstel voor metaal, gegolfde draad, vermessingd 75 mm x 0,3		
D-73346	Komborstel voor inox, gegolfde draad 75 mm x 0,3		
D-73374	Komborstel voor metaal, getordeerde draad 80 mm x 0,35		
D-73380	Komborstel voor metaal, getordeerde draad 80 mm x 0,5		
D-73330	Komborstel voor inox, getordeerde draad 80 mm x 0,5		
D-73449	Kegelborstel voor metaal, gegolfde draad 100 mm x 0,3		
D-73411	Schijfborstel voor metaal, getordeerde draad 115 mm x 0,5		
D-73427	Schijfborstel voor metaal, gegolfde draad 115 mm x 0,3		
E-11776	Doorslijpschijf TCG 125 mm x 2 x 22,23 X-LOCK		
NIEUW E-19738	Vacuüm gesoldeerde diamantschijf 125 mm		

ACCU KNABBELSCHAAR



		DJN161RTJ
Spanning		18 V
Bijgeleverde accu's		2 x BL1850B
Max. aantal snijbewegingen		1900 min ⁻¹
Max. dikte staal		1,6 mm
Gewicht		2,2 kg
Prijs in €	excl. btw	
	incl. btw	

ACCU PLAATSCHAREN



DJS800

- Geschikt voor het knippen van o.a. cementbeplating, brandwerende platen en geluidsisolatieplaten tot 13 mm dikte.
- Knijpt vrijwel stofvrij, snel en zonder lawaai.
- De snijkop is 360° draaibaar voor knippen op moeilijk bereikbare plaatsen.

bij alle modellen kan de kop 360° gedraaid worden

DJS131: kan bochten en gegolfde staalplaat snijden

DJS200: voor het knippen van rechte stukken met minimale vervorming

	DJS130ZJ	DJS200Z	DJS131Z	DJS800Z
Spanning	18 V	18 V	18 V	18 V
Bijgeleverde accu's	-	-	-	-
BL-motor	-	✓	✓	✓
Aantal zaagbewegingen	2800 min ⁻¹	0-3000 min ⁻¹	0-3000 min ⁻¹	0-3000 min ⁻¹
Max. dikte staal	1,3 mm	2,0 mm	1,3 mm	13 mm (vezelcement)
Gewicht	2,3 - 2,6 kg	2,2 - 2,5 kg	2,0 - 2,3 kg	2,1 - 2,5 kg
Prijs in €	excl. btw			
	incl. btw			

ACCU VLECHTMACHINE



DTR180ZJ



DTR181ZJ



Promo
DTR180ZJ :
gratis doos gegalvaniseerde
binddraad 191A57-9

DTR181

- Deze versie kan grotere verbindingen maken, tot bijvoorbeeld: (2 x 16 mm) + (2 x 13 mm) of 25 mm + 22 mm.

Optioneel accessoire:
handgreep 191M27-0



Polyester draad: 191J59-9
(100 m, Ø 0,8 mm) 50 stuks/doos



Vlechtendraad gegalvaniseerd: 191A57-9
(100 m, Ø 0,8 mm) 50 stuks/doos



Vlechtendraad staal: 199137-9
(100 m, Ø 0,8 mm) 50 stuks/doos

		DTR180ZJ	DTR181ZJ
Spanning		18 V / 14,4 V	18 V / 14,4 V
Bijgeleverde accu's		0	0
Vlechtcapaciteit		10 mm + 10 mm (2 x 13 mm) + (2 x 13 mm)	16 mm + 16 mm (2 x 16 mm) + (2 x 13 mm)
Draaddikte		0,8 mm	0,8 mm
Modus		Enkelvoudig/continu	Enkelvoudig/continu
Gewicht		2,3 kg	2,3 kg
Prijs in €	excl. btw		
	incl. btw		

ACCU VACUÛMPOMP



DVP181

- Kan continu werken dankzij twee accu's in parallel
- Tweetraps pomp met hoog debiet



DVP181ZK



DVP180Z

DVP180Z

DVP181ZK

		DVP180Z	DVP181ZK
Spanning		18 V	18 V, 2 accu's in parallel
Bijgeleverde accu/lader		-	-
Compressor		ééntraps olieafgedichte schottenpomp	Tweetraps olieafgedichte schottenpomp
Debiet		60 l/min	113 l/min
Eindvacuüm		20 Pa (150 micron)	3 Pa (22,5 micron)
Gewicht		2,9 kg	8,2 kg
Prijs in €	excl. btw		
	incl. btw		

ACCU KITPISTOOL



INCLUSIEF
kokerhouder
600 ml bij
DCG180RAX



600 ml



DCG180RAX



DCG180RA
300 ml

300 ml

DCG180RA

DCG180RAX

		DCG180RA	DCG180RAX
Spanning		18 V	18 V
Bijgeleverde accu's		1 x BL1820B	1 x BL1820B
Max. spuitdruk		5000 N	5000 N
Max. extrusiesnelheid		0-28 mm/s	0-28 mm/s
Gewicht		2,1 kg	2,4 kg
Prijs in €	excl. btw		
	incl. btw		

Voor gebruiksklaar afkorten zonder vonken

Mobiel afkorten



DSC102ZJ



DSC121ZK

Stationair afkorten



DSC102

	DSC102ZJ	DSC121ZK
Spanning	18 V	18 V
Bijgeleverde accu's	0	0
Snijcapaciteit	M6/M8/M10	M8/M10/M12
Inbegrepen messenset	M8/M10	M8
Gewicht	3,3 kg	5,7 kg
Prijs in €	excl. btw	
	incl. btw	

ACCU BETONIJSERZAAG

BL ADT
MOTOR



DSC251ZK

Spanning	18 V
Bijgeleverde accu's/lader	0
Snijcapaciteit	10-25 mm
Gewicht	3,9 kg
Prijs in €	excl. btw
	incl. btw

ACCU HYDRAULISCHE BETONIJSERKNIPPERS

BL
MOTOR **18V**
LITHIUM-ION



DSC163ZK

DSC163ZK DSC191Z

Spanning	18 V	18 V
Bijgeleverde accu's/lader	-	-
Snijcapaciteit	3 - 16 mm	3 - 20 mm
BL-motor	✓	-
Gewicht	6,9 kg	11,1 - 11,2 kg
Prijs in €	excl. btw	
	incl. btw	

ACCU PONSMACHINE



DPP200ZK

Spanning	18 V
Max. diameter ponsgat	20 mm
Inbegrepen Ø	12 mm
Max. dikte staal	8 mm
Max. dikte inox	6 mm
Gewicht	10,5 kg
Prijs in €	excl. btw
	incl. btw

Werkt met standaard 400 g patronen of vet in bulk



Debietregeling: automatisch of traag (met hoogste druk)



DGP180RT



DGP180RA

Hogedrukslang van 120 cm

	DGP180Z	DGP180RT
Spanning	18V	18V
Bijgeleverde accu's	-	1 x BL1850B
Maximale druk	690 bar	690 bar
Debiet	145-290 ml/min	145-290 ml/min
Gewicht	4,8 kg	4,8 kg
Prijs in €	excl. btw	
	incl. btw	



DVR850Z



- Voeding middels PDC01/ PDC1200 draagbaar accupack (accupack niet inbegrepen)
- Zeer comfortabel werken omdat enkel de trilnaald gehanteerd moet worden.
- Compatibel met flessen met grote diameter Ø 43 mm en Ø 52 mm
- Werktijd tot 300 minuten met PDC1200



VR004C



VR001C

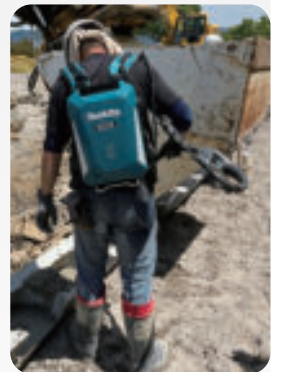

	DVR350Z	DVR450Z	DVR850Z
Spanning	18V	18V	18V
Bijgeleverde accu's	0	0	0
Lengte trilnaald	80 cm	120 cm	240 cm
Diameter trilnaald	25 mm	25 mm	25 mm
Gewicht	2,0 kg	2,3 kg	2,4 kg
Prijs in €	excl. btw		
	incl. btw		

	VR001CZ	VR002CZ	VR003CZ	VR004CZ
Spanning	36V (Direct connect)	36V (Direct connect)	36V (Direct connect)	36V (Direct connect)
Bijgeleverde accu's	-	-	-	-
Trilfrequentie	1200 min ⁻¹	1200 min ⁻¹	1200 min ⁻¹	1200 min ⁻¹
Ø trilflæs	43 mm	43 mm	52 mm	52 mm
Lengte trilnaald	1,5 m	3,0 m	1,5 m	3,0 m
Autonomie (PDC1200)	300 min	300 min	200 min	200 min
Gewicht	11,8 kg	12,9 kg	12,6 kg	13,7 kg
Prijs in €	excl. btw			
	incl. btw			

BESPAAR MET ONZE COMBOPACKS

PROMO

Gratis extra BL1830B bij al deze combopacks

MACHINES IN COMBOPACK 18 V		MACHINES 2 x 18 V	ACCU	DC18RC	MAK-PAC	PRIJS IN €
			3 x  BL1850B			DLX2289T3J
			3 x  BL1850B			DLX2189T3J
			2 x  BL1850B			DLX2440TJ
			3 x  BL1850B			DLX2236TJ1
			3 x  BL1850B		2 x 	DLX2235T3J
			3 x  BL1850B			DLX2434TJ
			4 x  BL1850B		3 x 	DLX2194PTJ
			3 x  BL1850B			DLX2245PT1

PROMO

Gratis extra BL1830B bij combopacks op deze pagina





BESPAAR MET ONZE COMBOPACKS

	DHP486	DTD153	DHR243	DGA506	DHS680	DJV181	DTM51
DLX2418TJ							
DLX4159TJ							
DLX5093TJ							
DLX5071TJ							
DLX6128JX1							
DLX1055JX1							
DLX1122JX1							

PROMO batterij BL1850B meteen geleverd in Makpac

Combineer voordelig
met deze aanbieding



DHR243T1J

DHP486T1J

DTD153T1J

DDF484T1J

DTM51T1JX2



TR0000001 TROLLEY



DJR188Z	DRT50JX3	DBO180ZJ	DDA351ZJ	BL1850B 18 V 5,0 Ah	DC18RC	KOFFER	PROMO	PRIJS IN €
				3 x 			PROMO BL1830B	
				3 x 		2 x	PROMO BL1830B 2 x	
				3 x 		3 x	PROMO BL1830B 2 x	
				3 x 		3 x	PROMO BL1830B 2 x	
				3 x 		4 x	PROMO 3x BL1830B	
				5 x 	2 x 	9 x	PROMO 3x BL1830B	
				5 x 	2 x 	10 x	PROMO 3x BL1830B	



DHS680T1J



DTW300T1J



DJV181T1J



DJV182T1J



DGA506T1J



DGA508T1J

Deze modellen bestaan ook in een voordelige 'Z-versie' zonder accu, lader, Makpac of andere extra toebehoren.



HET **LXT** -PLATFORM

DBN500ZJ

Minibradpistool 18 V
Prijs excl. BTW

Prijs incl. BTW

Makpac



DBN600ZJ

Bradpistool 18 V
Prijs excl. BTW

Prijs incl. BTW

Makpac



DBO180ZJ

Excentrische schuurmachine 18 V
Prijs excl. BTW

Prijs incl. BTW

Makpac



DBO380ZJ

Vlakschuurmachine 18 V
Prijs excl. BTW

Prijs incl. BTW

Makpac



DBO381ZJU

Vlakschuurmachine 18 V
Prijs excl. BTW

Prijs incl. BTW

Makpac



DBO480ZJ

Vlakschuurmachine 18 V
Prijs excl. BTW

Prijs incl. BTW

Makpac



DBO481ZJ

Vlakschuurmachine 18 V
Prijs excl. BTW

Prijs incl. BTW

Makpac



DBO482ZJ

Vlakschuurmachine 18 V
Prijs excl. BTW

Prijs incl. BTW

Makpac



DBS180ZJ

Bandschuurmachine 9 mm 18 V
Prijs excl. BTW

Prijs incl. BTW

Makpac



DCB200B

Verwamd deken 18 V
Prijs excl. BTW

Prijs incl. BTW

Karton



DCC501ZJ

Diamantzaag 125 mm 18 V
Prijs excl. BTW

Prijs incl. BTW

Makpac



DCG180ZK

Kitpistool 18 V
Prijs excl. BTW

Prijs incl. BTW

Koffer



DCG180ZXK

Kitpistool 18 V incl. kokerhouder
Prijs excl. BTW

Prijs incl. BTW

Koffer



DCO181Z

Gipsfrees 18 V
Prijs excl. BTW

Prijs incl. BTW

Karton



DCS552ZJ

Metaalcirkelzaag 18 V
Prijs excl. BTW

Prijs incl. BTW

Makpac



DCS553ZJ

Metaalcirkelzaag 18 V
Prijs excl. BTW

Prijs incl. BTW

Makpac



DDA351ZJ

Haakse boormachine 18 V
Prijs excl. BTW

Prijs incl. BTW

Makpac



DDA450ZK

Haakse boormachine 18 V
Prijs excl. BTW

Prijs incl. BTW

Koffer



DDF083ZJ

Boor- en schroefmachine 1/4" 18 V
Prijs excl. BTW

Prijs incl. BTW

Makpac



DDF482ZJ

Boor- en schroefmachine 18 V
Prijs excl. BTW

Prijs incl. BTW

Makpac



DDF484Z

Boor- en schroefmachine 18 V
Prijs excl. BTW

Prijs incl. BTW

Karton



DDF489ZJ

Boor- en schroefmachine 18 V
Prijs excl. BTW

Prijs incl. BTW

Makpac



NIEUW

DDF486ZJ

Boor- en schroefmachine 18 V
Prijs excl. BTW

Prijs incl. BTW

Makpac



DFN350ZJ

Minibradpistool 18 V
Prijs excl. BTW

Prijs incl. BTW

Makpac



DFR452ZJ

Schroefautomaat 18 V
Prijs excl. BTW

Prijs incl. BTW

Makpac



DFR550ZJ

Schroefautomaat 18 V
Prijs excl. BTW

Prijs incl. BTW

Makpac



DFR551ZJ

Schroefautomaat 18 V
Prijs excl. BTW

Prijs incl. BTW

Makpac



DFR750Z

Schroefautomaat 18 V
Prijs excl. BTW

Prijs incl. BTW

Karton



DFS250ZJ

Schroefmachine 18 V
Prijs excl. BTW

Prijs incl. BTW

Makpac



DFS452ZJ

Schroefmachine 18 V
Prijs excl. BTW

Prijs incl. BTW

Makpac



DGA506Z

Haakse slijper 125 mm 18 V
Prijs excl. BTW

Prijs incl. BTW

Karton



DGA508Z

Haakse slijper 125 mm 18 V
Prijs excl. BTW

Prijs incl. BTW

Karton



DGA513ZJ

Haakse slijper 125 mm 18 V
Prijs excl. BTW

Prijs incl. BTW

Makpac



DGA514ZJU

Haakse slijper 125 mm 18 V
Prijs excl. BTW

Prijs incl. BTW

Makpac



DGA517ZJ

Haakse slijper 125 mm 18 V
Prijs excl. BTW

Prijs incl. BTW

Makpac



DGA518ZJU

Haakse slijper 125 mm 18 V
Prijs excl. BTW

Prijs incl. BTW

Makpac



DGA519ZJ

Haakse slijper 125 mm X-lock 18 V
Prijs excl. BTW

Prijs incl. BTW

Makpac



DGA520ZX1

Haakse slijper 125 mm X-lock 18 V
Prijs excl. BTW

Prijs incl. BTW

Karton



DGA521ZX1

Haakse slijper 125 mm X-lock 18 V
Prijs excl. BTW

Prijs incl. BTW

Karton



DGD800ZJ

Stempelslijper 18 V
Prijs excl. BTW

Prijs incl. BTW

Makpac



DGP180Z

Vetpomp 18 V
Prijs excl. BTW

Prijs incl. BTW

Karton



DHG180ZJ

Heteluchtpistool 18 V
Prijs excl. BTW

Prijs incl. BTW

Makpac



DHG181ZJ

Heteluchtpistool 18 V
Prijs excl. BTW

Prijs incl. BTW

Makpac



DHP484ZJ

Klopboor- en schroefmachine 18 V
Prijs excl. BTW

Prijs incl. BTW

Makpac



DHP489ZJ

Klopboor- en schroefmachine 18 V
Prijs excl. BTW

Prijs incl. BTW

Makpac



DHP486Z

Klopboor- en schroefmachine 18 V
Prijs excl. BTW

Prijs incl. BTW

Karton



DHR171ZJ

SDS-PLUS Boorhamer 18 V
Prijs excl. BTW

Prijs incl. BTW

Makpac



DHR182ZJ

SDS-PLUS Boorhamer 18 V
Prijs excl. BTW

Prijs incl. BTW

Makpac



DHR182ZWJ

SDS-PLUS Boorhamer 18 V
Prijs excl. BTW

Prijs incl. BTW

Makpac



DHR183ZJ

SDS-PLUS Boorhamer 18 V
Prijs excl. BTW

Prijs incl. BTW

Makpac



DHR202ZJ

SDS-PLUS Boorhamer 18 V
Prijs excl. BTW

Prijs incl. BTW

Makpac



DHR243Z

SDS-PLUS Boorhamer 18 V
Prijs excl. BTW

Prijs incl. BTW

DHR243ZJW

SDS-PLUS Boorhamer 18 V + DX07
Prijs excl. BTW



Prijs incl. BTW

Makpac

DHR264ZJ

Combiamer SDS+ 2 x 18 V
Prijs excl. BTW



Prijs incl. BTW

Makpac

DHS630ZJ

Cirkelzaag 165 mm 18 V
Prijs excl. BTW



Prijs incl. BTW

Makpac

DHS660ZJ

Cirkelzaag 165 mm 18 V
Prijs excl. BTW



Prijs incl. BTW

Makpac

DHS661ZJU

Cirkelzaag 165 mm 18 V
Prijs excl. BTW



Prijs incl. BTW

Makpac

DHS680Z

Cirkelzaag 165 mm 18 V
Prijs excl. BTW



Prijs incl. BTW

Karton

DHS710ZJ

Cirkelzaag 190 mm 2 x 18 V
Prijs excl. BTW



Prijs incl. BTW

Makpac

DHS782ZJ

Cirkelzaag 190 mm 2 x 18 V
Prijs excl. BTW



Prijs incl. BTW

Makpac

DHS783ZJU

Cirkelzaag 190 mm 2 x 18 V
Prijs excl. BTW



Prijs incl. BTW

Makpac

DHS900Z

Cirkelzaag 235 mm 2 x 18 V
Prijs excl. BTW



Prijs incl. BTW

Karton

DHS900ZU

Cirkelzaag 235 mm 2 x 18 V
Prijs excl. BTW



Prijs incl. BTW

Karton

DJN161ZJ

Knabberschaar 18 V
Prijs excl. BTW



Prijs incl. BTW

Makpac

DJR183ZJ

Reciprozaag 18 V
Prijs excl. BTW



Prijs incl. BTW

Makpac

DJR186ZK

Reciprozaag 18 V
Prijs excl. BTW



Prijs incl. BTW

Koffer

DJR187ZK

Reciprozaag 18 V
Prijs excl. BTW



Prijs incl. BTW

Koffer

DJR188ZJ

Reciprozaag 18 V
Prijs excl. BTW



Prijs incl. BTW

Makpac

DJR189ZJ

Reciprozaag 18 V
Prijs excl. BTW
€ 215,00
Prijs incl. BTW



Prijs incl. BTW

Makpac

DJR360ZK

Reciprozaag 2 x 18 V
Prijs excl. BTW



Prijs incl. BTW

Koffer

DCV202ZL

Bodywarmer 18 V (maat: L)
Prijs excl. BTW



Prijs incl. BTW

Makpac

DCJ205ZL

Verwarmde jas 18 V (maat: L)
Prijs excl. BTW



Prijs incl. BTW

Karton

DCJ206ZXL

Verwarmde jas 18 V (maat: XL)
Prijs excl. BTW



Prijs incl. BTW

Karton

DJV181Z

Decoupeerzaag 18 V
Prijs excl. BTW



Prijs incl. BTW

Karton

DJV182Z

Decoupeerzaag 18 V
Prijs excl. BTW



Prijs incl. BTW

Karton

DJV184Z

Decoupeerzaag 18 V
Prijs excl. BTW



Prijs incl. BTW

Karton

DJV185Z

Decoupeerzaag 18 V
Prijs excl. BTW



Prijs incl. BTW

Karton

NIEUW

DKP181ZU

Schaaf 18 V
Prijs excl. BTW



Prijs incl. BTW

Karton

DLS600Z

Afkort-verstekzaag 165 mm 18 V
Prijs excl. BTW



Prijs incl. BTW

Karton

DPJ180ZJ

Lamellenfrees 18 V
Prijs excl. BTW



Prijs incl. BTW

Makpac

DPT353ZJ

Pinpistool 18 V
Prijs excl. BTW



Prijs incl. BTW

Makpac

DPV300ZJ

Schuur- en polijst-
machine 75 mm 18 V
Prijs excl. BTW



Prijs incl. BTW

Makpac

DRT50ZJ

Boven- en kantenfrees 18 V
Prijs excl. BTW



Prijs incl. BTW

Makpac

DRV150ZJ

Blindklinknagel-
pistool 18 V
Prijs excl. BTW



Prijs incl. BTW

Makpac

DRV250ZJ

Blindklinknagel-
pistool 18 V
Prijs excl. BTW



Prijs incl. BTW

Makpac

DSD180ZJ

Gipszaag 18 V
Prijs excl. BTW



Prijs incl. BTW

Makpac

DSP600ZJ

Invalcirkelzaag 165 mm 2 x 18 V
Prijs excl. BTW



Prijs incl. BTW

Makpac

DSS501ZJ

Cirkelzaag 136 mm 18 V
Prijs excl. BTW



Prijs incl. BTW

Makpac

DST112ZJ

Nietmachine 18 V
Prijs excl. BTW



Prijs incl. BTW

Makpac

DST221ZJ

Nietmachine 18 V
Prijs excl. BTW



Prijs incl. BTW

Makpac

DTD153Z

Slagschroeven-
draaier 18 V
Prijs excl. BTW



Prijs incl. BTW

Karton

DTD154ZJ

Slagschroeven-
draaier 18 V
Prijs excl. BTW



Prijs incl. BTW

Makpac

DTD156Z

Slagschroeven-
draaier 18 V
Prijs excl. BTW



Prijs incl. BTW

Karton

DTD157ZJ

Slagschroeven-
draaier 18 V
Prijs excl. BTW



Prijs incl. BTW

Makpac

DTD172ZJ

Slagschroeven-
draaier 18 V
Prijs excl. BTW



Prijs incl. BTW

Makpac

DTL061ZJ

Haakse
slagschroevendraaier 18 V
Prijs excl. BTW



Prijs incl. BTW

Makpac

DTM51Z

Multitool 18 V
Prijs excl. BTW



Prijs incl. BTW

Karton

DTM52ZJ

Multitool 18 V
Prijs excl. BTW



Prijs incl. BTW

Makpac

DTW1001ZJ

Slagmoersleutel 18 V
Prijs excl. BTW



Prijs incl. BTW

Makpac

DTW1002ZJ

Slagmoersleutel 18 V
Prijs excl. BTW



Prijs incl. BTW

Makpac

DTW180ZJ

Slagmoersleutel 18 V
Prijs excl. BTW



Prijs incl. BTW

Makpac

DTW181ZJ

Slagmoersleutel 18 V
Prijs excl. BTW



Prijs incl. BTW

Makpac

DTW190ZJ

Slagmoersleutel 18 V
Prijs excl. BTW



Prijs incl. BTW

Makpac

DTW300Z

Slagmoersleutel 18 V
Prijs excl. BTW



Prijs incl. BTW

Karton

DTW700ZJ

Slagmoersleutel 18 V
Prijs excl. BTW



Prijs incl. BTW

Makpac

DUT130Z

Menger 18 V
Prijs excl. BTW



Prijs incl. BTW

Karton

ACCU KOFFIEZETAPPARAAT



Ideaal voor op de bouw- en werkplaats. Werkt zowel met koffiepads als met gemalen koffie. Met één accu (LXT 5,0 Ah) maak je 3 koppen koffie van 160 ml.

DCM501Z

Spanning	10,8V/14,4V/18V	
Bijgeleverde accu's	0	
Inhoud waterreservoir	240 ml	
Bereidingstijd met 18 V accu (150 ml)	5 min.	
Gewicht	1,9 - 2,2 kg	
Prijs in €	excl. btw	
	incl. btw	

Promo
DCM501Z:
gratis extra accu BL1830B

ACCU WATERKOKER



- Dubbellaagse roestvrijstalen wand
- Met voedingsstandaard en groot handvat
- Uitgerust met morsbeveiliging

DKT360Z

Spanning	2x18V	
Inhoud	0,8 l	
Kooktijd voor 0,8 l	ca. 8 min	
Verwarmcapaciteit 100 °C	1,2 l met 2 x BL1850	
Gewicht	2,7 - 3,4 kg	
Prijs in €	excl. btw	
	incl. btw	

LUCHTPOMP



DMP180Z



Standaard met verschillende ventieladapters



Bedieningspaneel

De DMP181 is uitgerust met een groot display met achtergrondverlichting.



DMP181Z

DMP181

- Drie modi: hoog debiet, laag debiet en "ball" mode om op een veilige manier speelballen op te blazen.
- Functie voor het aflaten van lucht indien de druk te hoog is.

DMP180Z DMP181Z

Spanning	18V	18V
Bijgeleverde accu/lader	-	-
Debiet	10 l/min	11 - 22 l/min
Max. druk	8,3 bar	11,1 bar
Gewicht	1,5 kg	2,5 - 2,8 kg
Prijs in €	excl. btw	
	incl. btw	

BLAAS- EN ZUIGMACHINE



- Traploos regelbare snelheid met vario-schakelaar en voorkeuze van 4 maximumsnelheden.
- Verschillende mondstukken beschikbaar voor uiteenlopende toepassingen. Standaard worden 5 mondstukken meegeleverd.
- Kan ook gebruikt worden om lucht weg te zuigen via een speciaal opzetstuk (optioneel).
- Ideaal voor het reinigen van gereedschap en onderdelen. Kan ook gebruikt worden om bijvoorbeeld speelgoed voor op het water op te blazen of snel af te laten.



DAS180RT



DAS180Z DAS180RT

Spanning	18V	18V
Bijgeleverde accu	-	1x BL1850B
Max. debiet	1,1 m³/min	1,1 m³/min
Blaaskracht	2,8 N	2,8 N
Max. onderdruk	93 mbar	93 mbar
Gewicht	1,2 - 1,7 kg	1,2 - 1,7 kg
Prijs in €	excl. btw	
	incl. btw	

ACCU VERWARMD ONDERHEMD

DCX200 - DCX201

- DCX200 serie: met open ronde hals. DCX201 serie: met rechtopstaande kraag en halve ritssluiting
- Voeding middels 14,4V/18V LXT-batterij of compacte BL1055B
- Zeer dunne en elastische stof, waardoor het hemd onder andere kleding gedragen kan worden
- Vier warmtezones en 3 warmtestanden
- Machinewasbaar en geschikt voor droogkast



DEABL1055B
Powerbank



DCX200C

DCX201C

NIEUW **NIEUW**
DCX200C **DCX201C**

Maat	S-M-L-XL-2XL-3XL	
Voeding	14.4V/18V LXT BL1055B	14.4V/18V LXT BL1055B
Incl. batterijadapter	TD00000111	TD00000111
Model	Open hals	Met kraag en halve ritssluiting
Vermogenniveaus	2,3 W / 4,5 W / 9,5 W	2,3 W / 4,5 W / 9,5 W
Verwarmingszones	4	4
Materiaal	100% polyester	100% polyester
Machine wassen/ drogen	✓	✓
Prijs in €	Excl. BTW	
	Incl. BTW	

VERWARMD JASSEN / BODYWARMERS CXT & LXT



CJ106
DCJ206



CJ106
DCJ206



CV102
DCV202

CJ106 EN DCJ206:
HIGH VISIBILITY
(CONFORM
ISO 20471/ANSI107)

CV102 EN DCV202:
ZONDER MOUWEN
(BODYWARMER)

	CJ105DZ	DCJ205Z	CJ106DZ	DCJ206Z	CV102DZ	DCV202Z
Maat	S-M-L-XL-2XL-3XL					
Spanning	10,8 V	18 V	10,8 V	18 V	10,8 V	18 V
Model	Jas - zwart	Jas - zwart	Jas - High Visibility	Jas - High Visibility	Bodywarmer	Bodywarmer
Vermogen	2,3W - 7W - 11,5W	2,3W - 7W - 11,5W	2,3W - 7W - 11,5W	2,3W - 7W - 11,5W	2,3W - 4,5W - 9,5W	2,3W - 4,5W - 9,5W
Verwarmingszones	5	5	5	5	4	4
Materiaal buitenzijde	Polyester	Polyester	Polyester	Polyester	Polyester Spandex	Polyester Spandex
Materiaal binnenzijde	Fleece	Fleece	Fleece	Fleece	Fleece	Fleece
Water- & windresistent	✓	✓	✓	✓	✓	✓
Machine wassen/ drogen	✓	✓	✓	✓	✓	✓
Aantal zakken	6	6	6	6	4	4
Prijs in €	Excl. BTW					
	Incl. BTW					

ACCU VERWARMD DEKEN



DCB200B

**GESCHIKT VOOR
WASMACHINE &
DROOGKAST**

	CB100DB	DCB200B
Bijgeleverde accu's	0	0
Afmetingen (LxB)	700 x 1400 mm	
Vermogen	2,3 W - 4,5 W - 9,5 W	
Materiaal	Polyester	
Spanning	10,8 V	14,4 V / 18 V
Prijs in €	excl. btw	
	incl. btw	

ACCU BLUETOOTH-SPEAKERS

12V max
LITHIUM-ION

18V
LITHIUM-ION



USB

Bluetooth

DMR202
BLUETOOTH-SPEAKER
MET MEDIASPELER

LCD-display

USB-
mediaspeler



Bluetooth

Equalizer

DMR203
BLUETOOTH-SPEAKER
MET KOPPELFUNCTIE

Koppelbaar
per 2: True Wireless Stereo
tot 10: simultaan luisteren

ACCU RADIO'S

XGT
40V max
Li-ION

12V max
LITHIUM-ION

14.4V
LITHIUM-ION

18V
LITHIUM-ION

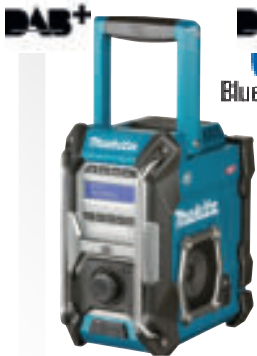

MR03GZ
WERFRADIO
XGT/ LXT



MR04GZ
WERFRADIO
XGT/ LXT



MR07GZ
WERFRADIO
XGT/ LXT



DMR301
WERFRADIO
CXT/LXT



DMR056
RADIO MET
LANTAARN LXT



MR009GZ
RADIO MET
LANTAARN XGT



GEREEDSCHAPSETS IN KOFFER

Onze favoriet!
E-10883 : 221-delige gereedschapskoffer voor kleine herstellingen



Scan mij voor meer info!



E-10883
GEREEDSCHAPSET
221-DELIG



E-06616
GEREEDSCHAPSKOFFER
120-DELIG

MAKPAC OPBERGSYSTEEM



- Inclusief 5 types van bakjes : 150x150 mm (1), 150x100 mm (1), 100x100 mm (2), 100x50 mm (3) en 50x50 mm (6)
- Bijkomende inzetbakjes zijn apart te verkrijgen
- Flexibel indeelbaar
- Koppelbaar met Makita Makpacs, Makstors, Makpac trolley TR00000001 en Makpac transportkar P-83886

191X80-2
395 x 295 x 110 mm
2.3 kg

MAKSTORS



P-84311 Makstor nr. 3 met 4 lades.



P-84333 Makstor nr. 3 met 6 lades



P-84327 Makstor nr. 3 met 12 lades



P-84349 Makstor nr. 4 met 5 lades

Koppelbaar met alle Makita Makpacs, alsook met Makpac IV koelbox 198253-4, de Makpac trolley TR00000001 en de Makpac transportkar P-83886

De lades van de Makstor zijn flexibel indeelbaar. Standaard worden er bij deze Makstor 8 verdelers / tussenschotten geleverd. De lades zijn voorzien van een vergrendelingssysteem en kunnen gelabeld worden

IDEAAL OM LOS MATERIAAL IN TE BEWAREN ZOALS BOREN EN BITSEN

Omschrijving	Ref.	Indeling	Afmetingen	Prijs excl. btw	Prijs incl. btw
Makstor nr. 3-4	P-84311	4 lades (1 groot / 2 klein / 1 middelgrote)	395 (L) x 295 (B) x 210 (H) mm		
Makstor nr. 3-12	P-84327	12 kleine lades	395 (L) x 295 (B) x 210 (H) mm		
Makstor nr. 3-6	P-84333	6 middelgrote lades	396 (L) x 295 (B) x 210 (H) mm		
Makstor nr. 4-5	P-84349	5 lades (2 groot / 2 klein / 1 middelgrote)	395 (L) x 295 (B) x 320 (H) mm		

LAMPEN

ZAKLAMPEN CXT



	DEAML103	DEAML104	DEAML105	DEAML106
Spanning	10,8 V (12Vmax)	10,8 V (12Vmax)	10,8 V (12Vmax)	10,8 V (12Vmax)
Max. lichtstroom	100 lm	710 lm	190 lm	190 lm
Verlichtingssterkte op 1 m	50 lx	340 lx (0,5 m, lantaarn)	5500 lx	170 - 4500 lx
Werkingsduur bij max intensiteit, accu BL1041B	28 u.	5,5 u.	14 u.	12 u.
Specifieke functionaliteiten	Uiterst compact	Lantaarn (360°) en zaklamp (gericht) USB uitgang	Reflector in 12 posities verstelbaar	Zoom functie
Afmetingen	77 x 54 x 28 mm	414 x 66 x 132 mm	249 x 66 x 93 mm	271 x 66 x 93 mm
Gewicht	0,27 - 0,43 kg	0,61 - 0,78 kg	0,53 - 0,7 kg	0,61 - 0,78
Prijs in €	excl. btw			
	incl. btw			

DEADML105 - DEADML815 - DEAML001G

Reflector 170° kantelbaar in 12 stappen

170°



DEADML104 - DEBDML806 - DEBDML807 - DEAML002G

3 modi: 360° zijdelings licht, 180° zijdelings licht en gericht licht (bovenaan).
USB uitgang Type A: 5V 2,4 A (behalve DEBDML806)

3 MODI

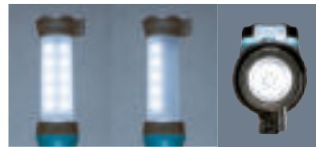

USB uitgang



DEADML810

Ontwerp met laag zwaartepunt zodat de lamp niet kan omvallen



WERFLAMPEN LXT



	DEADML805	DEADML811	DEADML809	BEADML810	DML813	DML814
Spanning	18 V / 14,4 V / AC	18 V / 14,4 V / AC	18 V / 14,4 V / AC	18 V / 14,4 V / AC	18 V / 14,4 V	18 V / 14,4 V
Max. lichtstroom	750 lm	3000 lm	10000 lm	5500 lm	3000 lx	3000 lx
Verlichtingssterkte op 1 m	300 lx	1800 lx	3800 lx	550 lx	1250 lx	1250 lx
Verlichtingssterkte op 3 m	-	200 lx	380 lx	70 lx	130 lx	130 lx
Verlichtingssterkte op 5 m	-	85 lx	150 lx	25 lx	50 lx	50 lx
Verlichtingscapaciteit naar voor/zijdelings	-	6 m/6 m	10 m/10 m	360°, ± 4 m	4,5 m/5,3 m	4,7 m/5,6 m
Werkingsduur bij max intensiteit, accu BL1850B	8,5 u.	3 u.	1,4 u (2x BL1850B)	3,5 u.	3 u. (2x BL1850B)	3 u. (2x BL1850B)
Specifieke functionaliteiten	DC/AC 2 helderheidsniveaus	DC/AC 3 helderheidsniveaus	DC/AC 3 helderheidsniveaus	DC/AC 3 helderheidsniveaus	Geïntegreerd statief	Geïntegreerd statief Met 3 afzonderlijk richtbare lichtunits
Afmetingen	214 x 261 x 328 mm	249 x 302 x 361 mm	249 x 379 x 370 mm	420 x 420 x 787 mm	573 x 658 x 1250-2240 mm	573 x 658 x 1250-2240 mm
Gewicht	2,3 - 2,7 kg	4,1 - 4,8 kg	5,7 - 7,0 kg	13,9 - 15,3 kg	7,2 - 7,9 kg	7,4 - 8,1 kg
Prijs in €	excl. btw					
	incl. btw					

DML813-DML814

Uitschuifbaar van 1250 mm tot 2240 mm
Gemakkelijk opvouwbaar voor transport



ZAKLAMPEN LXT



	DEADML803	DEBDM186	DEBDM1800	DEBDM1815	DEBDM1808	DEADML816	DEBDM1806	DECDML807	DEADML817	DEBDM1812
Spanning	18V/ 14,4V	18V/ 14,4V	18V/ 14,4V	18V/ 14,4V	18V/ 14,4V	18V / 14,4V	18V/ 14,4V	18V/ 14,4V	18V/ 14,4V	18V/ 14,4V
Max. lichtstroom	170 lm	-	100 lm	160 lm	190 lm	500 lm	620 lm (lantaarn)	710 lm (lantaarn)	300 lm	1000 lm (flood)
Verlichtingssterkte op 1 m	270 lx (0,5 m)	500 lx	2000 lx	3000 lx	170 - 4500 lx	800 lx (1m)	310 lx (0,5 m, lantaarn)	340 lx (0,5 m, lantaarn)	240 lx (0,5 m)	520 lx (0,5 m flood)
Werkingsduur bij max intensiteit, accu BL1850B	26 u.	83 u.	33 u.	45 u.	26 u.	75 h	21 u.	23 u.	23 u.	6,5 u (flood)
Specifieke functionaliteiten	Batterijhouder met riembevestiging	Met handriem	Hoofdlamp	Reflector in 12 posities kantelbaar	Zoom functie	Reflector draaibaar en kantelbaar	Lantaarn (360°) en zaklamp (gericht)	Lantaarn (360°) en zaklamp (gericht) USB uitgang	3 verlichtingsmodi USB uitgang	Modi: spot, flood, spot + flood
Afmetingen	133 x 81 x 72 mm	151 x 81 x 61 mm	133 x 76 x 88 mm	256 x 79 x 99 mm	280 x 79 x 10 mm	383 x 79 x 110 mm	365 x 78 x 119 mm	414 x 79 x 155 mm	107 x 77 x 50mm	313 x 119 x 115 mm
Gewicht	0,56 - 0,92 kg	0,51 - 0,83 kg	0,58 - 0,64 kg	0,26 - 0,93 kg	0,73 - 1,09 kg	0,70 - 1,1 kg	0,69 - 1,1 kg	0,72 - 1,1 kg	0,51 - 0,88 kg	1,2 - 1,6 kg
Prijs in €	excl. btw									
	incl. btw									

DEADML801- DEADML006G

De lichtkop is draaibaar, kantelbaar en opvouwbaar



Lichtstroom (Lumen, lm): de hoeveelheid uitgestraald licht per tijdseenheid. Het is een maat voor het vermogen van de lamp.

Verlichtingssterkte (Lux, lx): de lichtstroom per oppervlakte of dus de mate waarin een vlak verlicht wordt. De verlichtingssterkte is afhankelijk van de afstand tot de lichtbron.

Verlichtingscapaciteit: de zone waar de verlichtingssterkte minstens 70 lx is (de verlichtingssterkte die minimaal nodig is om veilig te kunnen werken).



4.5^{Front} m
(side: 5.3m)



DML813

Verlichtingscapaciteit

WERFLAMPEN LXT & XGT



NIEUW

EUAML010GZ
Voeding middels XGT accu's, LXT accu's of netstroom
• Tot 4 accu's kunnen tegelijkertijd gemonteerd worden
• Kan tot 80° kantelen zonder om te vallen
• Werktijd bij maximum intensiteit: 8,5 uur (2x BL4050F)
• Beschermingsklasse IP54 (bij werking op accu)



	DEAML003G	DEAML005G	DEAML009G	EUAML010G
Spanning	36V (40Vmax) /18V	36V (40Vmax) /18V	36V (40Vmax) /18V	40Vmax /18V/ 14,4 V / AC
Max. lichtstroom	1100 lm	3600 lm	10000 lm	5500 lm
Verlichtingssterkte op 1 m	500 lx	2100 lx	4300 lx	550 lx
Verlichtingssterkte op 3 m	-	230 lx	500 lx	70 lx
Verlichtingssterkte op 5 m	-	90 lx	110 lx	25 lx
Verlichtingscapaciteit naar voor/zijdelings	2,8 m/3,0 m	6,0 m/6,4 m	9,7 m/11,4 m	360°, ± 4 m
Werkingsduur bij max intensiteit, accu BL4040	10 u.	3,5 u.	2,4 u.	6,5 u (2x BL4040)
Specifieke functionaliteiten	2 helderheidsinstellingen	3 helderheidsinstellingen	3 helderheidsinstellingen	DC/AC 3 helderheidsniveaus
Afmetingen	249 x 298 x 280 mm	248 x 309 x 296 mm	248 x 386 x 305 mm	490 x 490 x 814 mm
Gewicht	3,7 - 4,7 kg	4,6 - 6,5 kg	6,4 - 9,9 kg	14,4 - 19,2 kg
Prijs in €	excl. btw			
	incl. btw			

ACCESSOIRES



Statief voor DML805
GM00002283



Spanvijs voor DML805
GM00001396



Statief voor DML809 / DML811 / ML003G-
GM00002073



ACCU BL1021B
12Vmax 2,0 Ah



197396-9
excl. btw
incl. btw

ACCU BL1041B
12Vmax 4,0 Ah



197406-2
excl. btw
incl. btw

OPLADER DC105B



197363-4
excl. btw
incl. btw

OPLADER DC18RE



LXT CXT
198720-9
excl. btw
incl. btw

Krachtig Compact Lichtgewicht

POWERPACK 12Vmax
2 x 2,0 Ah



197658-5
excl. btw
incl. btw

POWERPACK 12Vmax
2 x 4,0 Ah



197641-2
excl. btw
incl. btw

POWERPACK LXT + CXT



199026-8
excl. btw
incl. btw

POWERPACK LXT + CXT



199029-2
excl. btw
incl. btw

COMBOPACK CXT



CLX228SAX2



CLX206SAX3



CLX400SAJ1

PROMO

gratis lamp
DEAML103 bij
CLX228SAX2



CLX228SAX2 CLX206SAX3 CLX400SAJ1

Spanning	10,8V	10,8V	10,8V
Bijgeleverde accu's	3x BL1021B	2x BL1020B	3x BL1020B
Lader	DC105B	DC105A	DC105A
Samenstelling	HP333D TD110D	TM30D DF331D	DF331D TD110D HS301D JR103D
Makpac	-	-	1
Prijs in €	excl. btw		
	incl. btw		

ACCU BOOR- EN SCHROEFMACHINES

1/4" BITOPNAME



DF032DSAJ



DF033DWAJ

DF033DWAJ DF033DWMJ DF032DSAJ DF032DSMJ

Spanning	10,8 V	10,8 V	10,8 V	10,8 V
Bijgeleverde accu's	2 x BL1021B	2 x BL1040B	2 x BL1020B	2 x BL1040B
Hard koppel	30 Nm	30 Nm	35 Nm	35 Nm
BL-motor	-	-	✓	✓
Gewicht	0,9 kg	0,9 kg	0,9 kg	0,9 kg
Prijs in €	excl. btw			
	incl. btw			

ACCU BOOR- EN SCHROEFMACHINES



DF331DSMJ



DF333DNX10

DF333DNX10

Accu boor- & schroefmachine	DF333
Bijgeleverde accu's	2 x BL1850B
Bijgeleverde accu's	1 x BL1021B
Lader	DC18RE
BL-motor	-
Prijs in €	excl. btw
	incl. btw

DF333DWAJ DF333DWMJ DF332DSAJ DF332DSMJ

Spanning	10,8 V	10,8 V	10,8 V	10,8 V
Bijgeleverde accu's	2 x BL1021B	2 x BL1041B	2 x BL1020B	2 x BL1040B
Hard koppel	30 Nm	30 Nm	35 Nm	35 Nm
BL-motor	-	-	✓	✓
Gewicht	1,1 kg	1,1 kg	1,2 kg	1,2 kg
Prijs in €	excl. btw			
	incl. btw			

ACCU KLOPBOOR- EN SCHROEFMACHINES



HP332DSMJ



HP333DWAJ

HP333DWAJ HP332DSAJ HP332DSMJ

Spanning	10,8 V	10,8 V	10,8 V
Bijgeleverde accu's	2 x BL1021B	2 x BL1020B	2 x BL1040B
Hard koppel	30 Nm	35 Nm	35 Nm
BL-motor	-	✓	✓
Gewicht	1,1 kg	1,1 kg	1,3 kg
Prijs in €	excl. btw		
	incl. btw		

ACCU SLAGSCHROEVENDRAAIERS



TD111DSMJ



TD110DSAJ



Assist modus voor het vlot aanzetten bij het schroeven.

TD110DSAJ TD110DSMJ TD111DZJ TD111DSAJ TD111DSMJ

Spanning	10,8 V	10,8 V	10,8 V	10,8 V	10,8 V
Bijgeleverde accu's	2 x BL1020B	2 x BL1040B	0	2 x BL1020B	2 x BL1040B
Max. koppel	110 Nm	110 Nm	135 Nm	135 Nm	135 Nm
BL-motor	-	-	✓	✓	✓
Assist modus	-	-	✓	✓	✓
Gewicht	1,0 kg	1,0 kg	1,0 kg	1,0 kg	1,0 kg
Prijs in €	excl. btw				
	incl. btw				

SCHROEFBITSET (35 STUKS) IMPACT BLACK



Schroefbitset B-66880
35 stuks Impact Black

ACCU BOORHAMERS SDS-PLUS



HR166DSMJ

HR140DSAJ

		HR140DSAJ	HR140DSMJ	HR166DSMJ
Spanning		10,8 V	10,8 V	10,8 V
Bijgeleverde accu's		2 x BL1020B	2 x BL1040B	2 x BL1040B
Slagenergie		1,0 J	1,0 J	1,1 J
Max. Ø beton		14 mm	14 mm	16 mm
BL-motor		-	-	✓
Gewicht		1,9 kg	1,9 kg	1,8 kg
Prijs in €	excl. btw			
	incl. btw			

ACCU HAAKSE BOORMACHINES

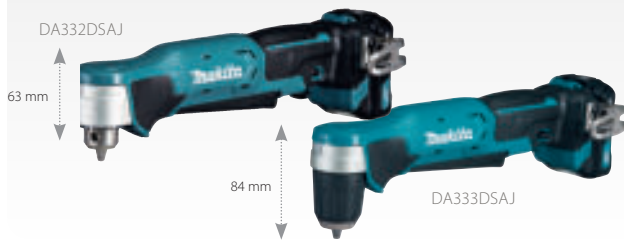

DA332DSAJ

DA333DSAJ

		DA332DSAJ	DA332DSMJ	DA333DSAJ	DA333DSMJ
Spanning		10,8 V	10,8 V	10,8 V	10,8 V
Bijgeleverde accu's		2 x BL1020B	2 x BL1040B	2 x BL1020B	2 x BL1040B
Boorkop		1,5-10 mm	1,5-10 mm	1,5-10 mm	1,5-10 mm
Gewicht		1,2 kg	1,2 kg	1,2 kg	1,2 kg
Prijs in €	excl. btw				
	incl. btw				

ACCU HAAKSE SLAGSCHROEVENDRAAIERS



TL064DZJ

TL065DZJ

Opname
1/4"

Opname
3/8"

		TL064DZJ	TL065DZJ
Spanning		10,8 V	10,8 V
Bijgeleverde accu's		0	0
Toerental		0-2000 t.p.m.	0-2000 t.p.m.
Gewicht		1,2 kg	1,2 kg
Prijs in €	excl. btw		
	incl. btw		

ACCU SLAGMOERSLEUTELS



TW141DSMJ

TW161DSMJ

Reverse Auto-stop:
Rotatie stopt automatisch
wanneer de bout of moer is
losgedraaid

		TW140DZJ	TW140DSAJ	TW140DSMJ	TW141DZJ	TW141DSMJ	TW160DZJ	TW160DSAJ	TW160DSMJ	TW161DZJ	TW161DSMJ
Spanning		10,8 V	10,8 V	10,8 V	10,8 V	10,8 V	10,8 V	10,8 V	10,8 V	10,8 V	10,8 V
Bijgeleverde accu's		0	2 x BL1021B	2 x BL1041B	0	2 x BL1041B	0	2 x BL1021B	2 x BL1041B	0	2 x BL1041B
Toerental		0-2600 t.p.m.	0-2600 t.p.m.	0-2600 t.p.m.	0-2600 t.p.m.	0-2600 t.p.m.	0-1300 t.p.m. 0-2400 t.p.m.	0-1300 t.p.m. 0-2400 t.p.m.	0-1300 t.p.m. 0-2400 t.p.m.	0-1300 t.p.m. 0-2400 t.p.m.	0-1300 t.p.m. 0-2400 t.p.m.
Max. koppel		140 Nm	140 Nm	140 Nm	145 Nm	145 Nm	165 Nm	165 Nm	165 Nm	165 Nm	165 Nm
Snelheden		1	1	1	1	1	2	2	2	2	2
Auto-stop functie		-	-	-	-	-	✓	✓	✓	✓	✓
Opname		3/8"	3/8"	3/8"	1/2"	1/2"	3/8"	3/8"	3/8"	1/2"	1/2"
BL-motor		-	-	-	-	-	✓	✓	✓	✓	✓
Gewicht		1,0 kg	1,0 kg	1,0 kg	1,1 kg	1,1 kg	1,0 kg	1,0 kg	1,0 kg	1,1 kg	1,1 kg
Prijs in €	excl. btw										
	incl. btw										

ACCU RATELMOERSLEUTEL



Geleverd met 1/4" & 3/8" opname

Verwijderbare kop laat toe om 13 mm moeren over de lengte van een M8 draadstang te schroeven.



		WR100DZ
Spanning		10,8V
Toerental onbelast		800 t.p.m.
Max. koppel		47,5 Nm
Bijgeleverde accu's		-
Gewicht		1,0 kg
Prijs in €	excl. btw	
	incl. btw	

ACCU NIETMACHINE



ST113DSAJ

Met repeteerfunctie en anti-droogschietmechanisme

		ST113DZJ	ST113DSAJ	ST113DSMJ
Spanning		10,8V	10,8V	10,8V
Bijgeleverde accu's		-	2 x BL1020B	2 x BL1040B
Rugbreedte niet		10 mm	10 mm	10 mm
Ladercapaciteit		150 stuks	150 stuks	150 stuks
Gewicht		1,3 kg	1,3 kg	1,5 kg
Prijs in €	excl. btw			
	incl. btw			

ACCU PINPISTOOL



PT354DZJ

		PT354DZJ
Spanning		10,8V
Bijgeleverde accu's		-
Draadkaliber		23 Ga
Doorsnede nagel		0,6 mm
Lengte nagel		15-35 mm
Gewicht		2,0 kg
Prijs in €	excl. btw	
	incl. btw	

LUCHTPOMP



MP100DZ

Spanning		10,8V
Bijgeleverde accu's		-
Debiet		10 l/min (bij 2 bar)
Max. druk		8,3 bar
Gewicht		1,2 kg
Prijs in €	excl. btw	
	incl. btw	

ACCU SCHUUR-/POLIJSTMACHINE 75 MM



- Geleverd met adapter voor Roloc™ voor schuurtoepassingen en een velcro steunschijf voor het polijsten
- Ideaal voor oppervlaktebehandeling en voor het polijsten van kleine oppervlakken



		PV301DZJ	PV301DSAEJ
Spanning		10,8V	10,8V
Bijgeleverde accu's		-	2x BL1021B
Capaciteit polijsten		80 mm	80 mm
Capaciteit schuren		50 mm	50 mm
Toerental polijsten		0-2800 min ⁻¹	0-2800 min ⁻¹
Toerental schuren		0-9500 min ⁻¹	0-9500 min ⁻¹
Gewicht		1,1 kg	1,1 kg
Prijs in €	excl. btw		
	incl. btw		

ACCU CIRKELZAAG 85 MM



HS301DSAJ

		HS301DSAJ	HS301DSMJ
Spanning		10,8V	10,8V
Bijgeleverde accu's		2 x BL1020B	2 x BL1040B
Max. zaagdiepte bij (90°)		25,5 mm	25,5 mm
Ø Zaagblad		85 mm	85 mm
Gewicht		1,6 kg	1,6 kg
Prijs in €	excl. btw		
	incl. btw		

ACCU TEGELSNIJDER 85 MM



CC301DSMJ



		CC301DZJ	CC301DSMJ
Spanning		10,8V	10,8V
Bijgeleverde accu's		-	2 x BL1040B
Zaagdiepte (90°)		25,5 mm	25,5 mm
Ø Zaagblad		85 mm	85 mm
Gewicht		1,9 kg	1,9 kg
Prijs in €	excl. btw		
	incl. btw		

ACCU DRAADSTANGKNIPPER



Voor gebruiksklaar afkorten zonder vonken!

SC103DZJ

Spanning		10,8V
Bijgeleverde accu's		-
Afkorten		Mobiel
Snijcapaciteit		M6 - M8 - M10
Inbegrepen mes		M8, M10
Gewicht		2,7 kg
Prijs in €	excl. btw	
	incl. btw	

ACCU MULTICUTTER



CP100DZJ

Spanning		10,8V
Bijgeleverde accu's		-
Snijcapaciteit		6 mm
Gewicht		0,72 kg
Prijs in €	excl. btw	
	incl. btw	

ACCU GIPSZAAG



SD100DZJ

Spanning		10,8V
Bijgeleverde accu's		-
Slaglengte		6 mm
Snijcapaciteit		30 mm
Gewicht		1,5 kg
Prijs in €	excl. btw	
	incl. btw	

ACCU DECOUPEERZAGEN

10.8v CXT



JV102DSAJ



JV103DSAJ

	JV101DSAJ	JV102DZJ	JV102DSAJ	JV102DSMJ	JV103DZJ	JV103DSAJ	JV103DSMJ
Spanning	10,8V	10,8V	10,8V	10,8V	10,8V	10,8V	10,8V
Bijgeleverde accu's	2 x BL1020B	0	2 x BL1020B	2 x BL1040B	0	2 x BL1020B	2 x BL1040B
Aantal zaagbewegingen	0-2900 /min	800-3000 /min	800-3000 /min	800-3000 /min	800-3000 /min	800-3000 /min	800-3000 /min
Max. capaciteit hout	65 mm	90 mm	90 mm	90 mm	90 mm	90 mm	90 mm
BL-motor	-	✓	✓	✓	✓	✓	✓
Gewicht	1,8 kg	1,8 kg	1,8 kg	1,8 kg	1,8 kg	1,8 kg	1,8 kg
Prijs in €	excl. btw						
	incl. btw						

ACCU RECIPROZAAG

10.8v CXT



JR103DSAJ

	JR103DSAJ	JR103DSMJ
Spanning	10,8V	10,8V
Bijgeleverde accu's	2 x BL1020B	2 x BL1040B
Max. zaagcapaciteit hout/stalen buis	50 mm	50 mm
Gewicht	1,3 kg	1,5 kg
Prijs in €	excl. btw	
	incl. btw	

ACCU MULTITOOl

10.8v CXT



TM30DSAJX3

Spanning	10,8V
Bijgeleverde accu's	2 x BL1020B
Oscillatiehoek	3,2°
Oscillatiefrequentie	6000-20000 min ⁻¹
Opname	OIS, Starlock
Gewicht	1,1 kg
Prijs in €	excl. btw
	incl. btw

ACCU KITPISTOOL

CXT 10.8v



CG100DSAEA

CG100DSAEB

CG100DSAEB met aluminium kokerhouder 600 ml (voor worsten of kit in bulkverpakking)

	CG100DSAEA	CG100DSAEB
Spanning	10,8V	10,8V
Bijgeleverde accu's	2 x BL1020B	2 x BL1020B
Max. extrusiekracht	5000 N	5000 N
Max. extrusiesnelheid	0-28 mm/s	0-28 mm/s
Prijs in €	excl. btw	
	incl. btw	

STEELOFZUIGERS MET GEÏNTEGREERDE ACCU



	CL114DWIX	CL117FDX2	CL117FDX5	CL117FDX8
Spanning	10,8 V	10,8V	10,8 V	10,8 V
Bijgeleverde accu's	Geïntegreerd	Geïntegreerd	Geïntegreerd	Geïntegreerd
Max. debiet	1,4 m³/min	1,0 m³/min	1,0 m³/min	1,0 m³/min
Max. onderdruk	34 mbar	50 mbar	50 mbar	50 mbar
Stofopvang	Stofzak	Capsule	Capsule	Capsule
Klikvergrendeling	✓	✓	✓	✓
Kleur	Beige	Turquoise	Groen	Purper
Promo	-	-	-	-
Gewicht	0,94 kg	1,0 kg	1,0 kg	1,0 kg
Prijs in €	excl. btw			
	incl. btw			
	btw			

CYCLONMODULE

- ✓ Het grove stof wordt van het fijne stof gescheiden.
- ✓ Stofzak of capsule voor het fijn stof tot 80 % minder vaak ledigen!
- ✓ Het reservoir van de module is zeer gemakkelijk te ledigen en uit te wassen.

Gemakkelijk te ledigen

Extra opvangcapaciteit
400 ml



OPTIONELE ACCESSOIRES



Ref.	Kleur	Prijs excl. btw	Prijs incl. btw
Cyclonmodule met klikvergrendeling			
191D71-3	wit		
191D73-9	zwart		
Cyclonmodule zonder klikvergrendeling			
199491-1	wit		
191d75-5	zwart		

STEELOFZUIGERS CXT/ LXT



PROMO:
DCL182Z: gratis cyclon 199491-1 + muurbevestiging
DCL280FZW: gratis cyclon 191D71-3 + muurbevestiging

DCL284, DCL285 & DCL286:

- Nieuwe brushless motor levert hoge zuigkracht.
- Laag geluidsniveau door vernieuwd ontwerp van luchtuitlaat.
- De DCL286 heeft een ingebouwde cyclonmodule: deze vangt grove stofdeeltjes op waardoor de optimale zuigkracht langer behouden blijft.



	CL102DW	CL107FDZW	DCL180ZB	DCL182Z	DCL280FZW	DCL282FZ	DCL284FZB	DCL284FRFB	DCL285FZ	DCL285FRF	DCL286FZW	DCL286FRFW
Spanning	10,8 V	10,8 V (CXT)	18 V (LXT)	18 V (LXT)	18 V (LXT)	18 V (LXT)	18 V (LXT)	18 V (LXT)	18 V (LXT)	18 V (LXT)	18 V (LXT)	18 V (LXT)
Bijgeleverde accu's	1 x BL1013	-	-	-	-	-	-	1x BL1830	-	1x BL1830	-	1x BL1830
Max. debiet	0,9 m³/min	1,4 m³/min	1,4 m³/min	1,4 m³/min	1,5 m³/min	1,5 m³/min	1,2 m³/min	1,2 m³/min	1,2 m³/min	1,2 m³/min	1,0 m³/min	1,0 m³/min
Max. onderdruk	23 mbar	50 mbar	42 mbar	54 mbar	60 mbar	82 mbar	180 mbar	180 mbar	180 mbar	180 mbar	180 mbar	180 mbar
Stofopvang	Stofzak	Stofzak	Capsule	Stofzak	Capsule	Stofzak	Capsule	Capsule	Stofzak	Stofzak	Cyclon	Cyclon
Klikvergrendeling	-	-	-	-	✓	✓	✓	✓	✓	✓	✓	✓
BL motor	-	-	-	-	✓	✓	✓	✓	✓	✓	✓	✓
Kleur	Wit	wit	Zwart	Blauw	Wit	Blauw	zwart/turquoise	zwart/turquoise	Blauw	Blauw	Wit	Wit
Gewicht	1,1 kg	1,1 - 1,3 kg	1,2 kg	1,3 kg	1,2 - 1,6 kg	1,3 - 1,6 kg	1,3 - 1,6 kg	1,3 - 1,6 kg	1,4 - 1,7 kg	1,4 - 1,7 kg	1,6 - 1,9 kg	1,6 - 1,9 kg
Prijs in €	excl. btw											
	incl. btw											

XGT STEELSTOFZUIGERS



CL002GD205

CL001GD208



CL002GD212

	CL001GZ05	CL001GD208	CL002GZ03	CL002GD205	CL002GZ07	CL002GD212	CL003GZ04
Spanning	40Vmax	40Vmax	40Vmax	40Vmax	40Vmax	40Vmax	40Vmax
Bijgeleverde accu's	-	2x BL4025	-	2x BL4025	-	2x BL4025	-
Bijgeleverde lader	-	DC40RA	-	DC40RA	-	DC40RA	-
Max. debiet	1,2 m³/min	1,2 m³/min	1,2 m³/min	1,2 m³/min	1,2 m³/min	1,2 m³/min	1,0 m³/min
Max. onderdruk	210 mbar	210 mbar	210 mbar	210 mbar	210 mbar	210 mbar	200 mbar
Stofopvang	Capsule	Capsule	Stofzak	Stofzak	Stofzak	Stofzak	Cycloon-capsule
Klikvergrendeling	✓	✓	✓	✓	✓	✓	✓
Kleur	Turquoise	Turquoise	Zwart	Zwart	Wit	Wit	Zwart
Gewicht	1,7 - 2,3 kg	1,7 - 2,3 kg	1,7 - 2,3 kg	1,7 - 2,3 kg	1,7 - 2,3 kg	1,7 - 2,3 kg	1,9 - 2,5 kg
Prijs in €	excl. btw						
	incl. btw						

CLEANING COMBOPACK



CLX245SAX1

Spanning	10,8V
Meegeleverde accu's	1 x BL1021B
Lader	DC10SB
Steelstofzuiger	CL108FDZW
Blaas-/ zuigmachine	UB100DZ
Gereedschapstas	✓
Prijs in €	excl. btw
	incl. btw

ACCU CYCLOONSTOFZUIGER



DCL501Z

DCL501Z

Spanning	18V
Bijgeleverde accu's	0
Max. debiet	1,3 m³/min
Max. onderdruk	66 mbar
Gewicht	3,1 kg
Prijs in €	excl. btw
	incl. btw

Technologie



Auto-start wireless system

Geniet van stofvrij werken met AWS!

Bij het starten van de accu-machine wordt de stofzuiging automatisch geactiveerd d.m.v. een Bluetooth verbinding. Wanneer het verbonden toestel uitgeschakeld wordt, gaat de stofzuiger weer in stand-by modus. Sommige accustofzuigers zoals VC009 of DVC867 hebben AWS reeds standaard ingebouwd en kunnen dus rechtstreeks communiceren met AWS-compatibele gereedschappen.

Via de optionele adapter WUT02U kunnen nu ook stofzuigers op netstroom draadloos aangestuurd worden, ongeacht het merk. De enige vereiste is dat de stofzuiger met een startautomatiek uitgerust is.

AWS-compatibele stofzuiger



DVC867L



Stofzuiger met startautomatiek



+



Adapter WUT02U 199773-1



Bluetooth unit 198900-7



ACCU BLAAS- EN ZUIGMACHINE



UB101DZ & DUB186:
uitvoering met lange pijp,
ideaal om laag bij de grond
te blazen.

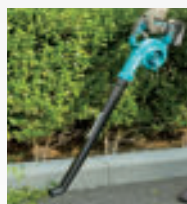

DUB186Z

DUB185Z

	UB100DZ	UB101DZ	DUB185Z	DUB186Z
Spanning	10,8V	10,8V	18V	18V
Max. luchtsnelheid	75 m/s	65 m/s	98 m/s	68 m/s
Max. debiet	2,6 m³/min	2,6 m³/min	3,2 m³/min	3,2 m³/min
Gewicht	1,4 kg	1,4 kg	1,6 kg	1,6 kg
Prijs in €	excl. btw			
	incl. btw			

BLAAS- EN ZUIGMACHINE



Multifunctionele schakelaar met snelheidsinstelling

	UB1103
Vermogen	600 W
Max. luchtsnelheid	91 m/s
Max. debiet	4,1 m³/min
Gewicht	2,0 kg
Prijs in €	excl. btw
	incl. btw

ACCU RUGGEDRAGEN STOFZUIGERS



DVC660

DVC665



DVC660
Uitvoering speciaal voor schoonmaak,
geleverd met diverse accessoires.

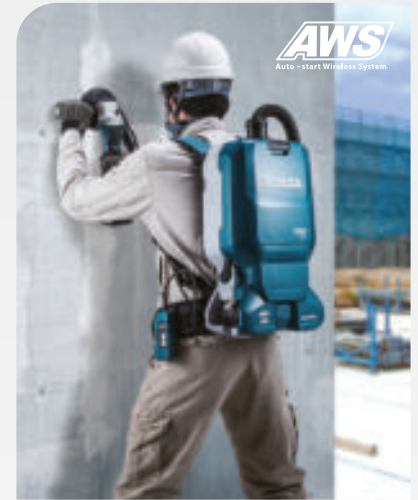

DVC665
Uitvoering voor stofafzuiging in
combinatie met machines.



HEPA-filter

Als hoofdfilter wordt een HEPA-filter gebruikt die zeer fijne stofdeeltjes effectief tegenhoudt. De filter kan tot 99,97 % van de deeltjes tussen 0,3 en 1 µm filteren, waardoor de uitgeblazen lucht zeer zuiver is.



Filterreiniging

Door de trillingen van het stappen of het manueel indrukken van de hendel wordt het fijn stof van de papierfilter geschud. Daardoor blijft de zuigkracht langer optimaal bij het opzuigen van fijn stof.



DVC265ZXU DVC261ZX11 DVC660Z DVC665ZX1U

Spanning	2 x 18V	2 x 18V	2 x 18V	2 x 18V
Max. debiet	1,8-2,2 m³/min	1,8-2,2 m³/min	1,8-2,2 m³/min	1,8-2,2 m³/min
Max. onderdruk	110 mbar	110 mbar	110 mbar	110 mbar
Uitvoering	Stofafzuiging machines	Schoonmaak	Schoonmaak	Stofafzuiging machines
Capaciteit stofzak	2l	2l	6l	6l
AWS	✓	-	-	✓
Gewicht	3,9 kg	3,8 kg	6,1 kg	6,1 kg
Prijs in €	excl. btw			
	incl. btw			

ACCU RUGGEDRAGEN STOFZUIGERS



VC008GZ



VC009GZ
(Geleverd zonder batterijen en zonder oplader)

- Hogere zuigkracht dankzij de 40Vmax accutechnologie
- Geluidsarm door een hertekend design van de luchtuitlaat en gebruik van geluidsabsorberend materiaal.
- VC008GZ wordt standaard geleverd met accessoires voor schoonmaakt toepassingen.
- VC009GZ01 wordt geleverd met twee zuigslangen en hulpstukken voor stofafzuiging in combinatie met machines.

VC008GZ VC009GZ01

Spanning	40Vmax	40Vmax
Max. debiet	2,4 m³/min	1,9 m³/min
Max. onderdruk	180 mbar	180 mbar
Uitvoering	Schoonmaak	Stofafzuiging machines
Capaciteit stofzak	2,0l	2,0l
AWS	-	✓
Gewicht	4,1 - 5,3 kg	4,1 - 5,3 kg
Prijs in €	excl. btw	
	incl. btw	

ACCU RECHTOPSTAANDE STOFZUIGER

18V + 18V → 36V

Met roterende borstel, ideaal voor tapijt
 Aparte motor voor het aandrijven van de borstel
 Telescopische aluminium steel



Met aparte aluminium buis om moeilijk bereikbare plaatsen te reinigen



Zeer wendbaar, geen voedingskabel en geen zuigslang!

3 vermogenstanden



Instelbare hoogte van de borstel (4 hoogtes, max 10 mm)



DVC560Z

Spanning	2 x 18V	
Bijgeleverde accu's	0	
Max. debiet	1,9 m³/min	
Max. onderdruk	120 mbar	
Gewicht	8,3 kg	
Prijs in €	excl. btw	
	incl. btw	

ACCU COMPACTE STOFZUIGER

LXT 18V LITHIUM-ION



Inclusief draagriem, vloerzuigmond & kierzuigmond

DVC750LZX1

Spanning	18V	
Bijgeleverde accu's	0	
Max. debiet	1,4 m³/min	
Max. onderdruk	64 mbar	
Gewicht	4,2 kg	
Prijs in €	excl. btw	
	incl. btw	

ACCU COMPACTE STOFZUIGER

12V max LITHIUM-ION

18V LITHIUM-ION

IDEAAL VOOR DE AUTO



DCL184Z

Met blaasfunctie

Inclusief accessoires

CL121DZJ DCL184Z

Spanning	10,8V	18V
Bijgeleverde accu's	-	-
Lader	-	-
Max. debiet	1,3 m³/min	1,3 m³/min
Max. onderdruk	44 mbar	47 mbar
Gewicht	1,7	2,1 kg
Prijs in €	excl. btw	
	incl. btw	

Zuigmond voor matten



Zuigmond voor zetels



Rubberen zuigmond



Zachte borstel



Blaasmond



DRC200

- Verschillende sensoren voor obstakel- en grensdetectie
- Patroonmodus voor grote vloeroppervlakken met weinig obstakels, zoals een magazijn of een lange gang
- Willekeurige modus voor vloeroppervlakken met veel obstakels, zoals in een kantoor.
- Door middel van grenstape kan de gebruiker de zone afbakenen waarbinnen de robot mag werken.
- Modi "alleen borstelen" of "stofzuigen + borstelen"
- Bediening op het toestel zelf of met bijgeleverde afstandsbediening
- Werkt op één 18 V accu of twee in parallel. De accu's moeten uit het toestel verwijderd worden om op te laden.



DRC200PTJ

OPPERVLAKTE
TOT 500 m²

Patroonmodus

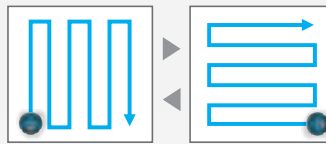

Willekeurige modus

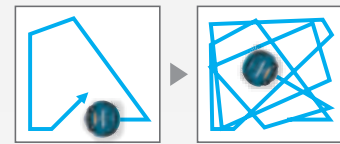

OPPERVLAKTE
TOT 600 m²



DRC300Z



De camera maakt beelden van het plafond ter ondersteuning van de navigatie



DRC300

- Kan ruimtes in kaart brengen door gebruik te maken van LiDAR module en beeldcamera. Tot 5 ruimtes kunnen in het geheugen bewaard worden. Dankzij de intelligente positiebepaling kan een ruimte efficiënter gereinigd worden en kan de machine ook automatisch terugkeren naar het beginpunt
- Verschillende sensoren voor obstakel- en grensdetectie
- Modi "alleen borstelen" of "stofzuigen + borstelen"
- Bediening op het toestel zelf, met de afstandsbediening of met de smartphone app (Wifi verbinding)
- Via de smartphone app kunnen de bewaarde kaarten weergegeven en geoptimaliseerd worden (bv. het definiëren van verboden zones) en kan ook schoonmaakstatus en -historiek gecontroleerd worden
- Werkt op één 18 V accu of twee in parallel. De accu's moeten uit het toestel verwijderd worden om op te laden.

DRC200Z DRC200PTJ DRC300Z

Spanning	18 V (één of 2 in parallel)		
Bijgeleverde accu's	-	2 x BL1850B	-
Lader	-	DC18RD	-
Capaciteit opvangbak	2,5 l	2,5 l	3,0 l
Max. registreerbare oppervlakte	-	-	10000 m ²
Max. snelheid	0,3 m/s	0,3 m/s	0,3 m/s
Navigatie	Willekeurig of vast patroon	Willekeurig of vast patroon	Intelligent op basis van kaart
LiDAR sensor	-	-	✓
Camera	-	-	✓
Configuratie en besturing met app	-	-	✓
Afbakenen van verboden zones	Tape	Tape	Tape of via app
Terugkeren naar beginpunt	-	-	✓
Gewicht	6,8 - 7,8 kg	6,8 - 7,8 kg	9,6 - 10,6 kg
Prijs in €	excl. btw		
	incl. btw		

ACCU STOFZUIGERS L-KLASSE LXT



Promo DVC863LZ:
gratis
2 x batterij BL1830B



	DVC150LZ	DVC155LZX2	DVC863LZ	DVC867LZX4	DVC157LZX3
Spanning	2 x 18 V / 230 V	2 x 18 V	2 x 18 V	2 x 18 V	2 x 18 V
Bijgeleverde accu	-	-	-	-	-
Kuipvolume	15 l	15 l	8 l	8 l	15 l
Type	Nat & Droog	Nat & Droog	Droog	Droog	Droog
Filter	Textielfilter	Textielfilter	HEPA	HEPA	HEPA
Max. debiet	2,1 / 3,6 m ³ /min	2,1 m ³ /min	2,1 m ³ /min	2,4 m ³ /min	2,4 m ³ /min
Max. onderdruk	90 / 240 mbar	110 mbar	98 mbar	110 mbar	110 mbar
AWS	-	-	-	✓	✓
Gewicht	8,9 kg	7,9 kg	7,9 kg	7,8 kg	8,0 kg
Prijs in €	excl. btw				
	incl. btw				

ACCU STOFZUIGERS L-KLASSE XGT



- Voeding met twee 40Vmax accu's in parallel.
- Hoge zuigkracht dankzij hoger vermogen en verbeterde koeling.
- Met telescopische steel (VC001G/VC003G/VC005G)
- Vloerborstel met laag profiel en verstelling voor harde vloer of tapijt (VC001G/VC003G/VC005G).
- VC005G: hoge wendbaarheid en stabiliteit door extra grote wielen achteraan.

Toepassing:

- VC001G / VC003G: voor algemeen droog en nat gebruik (schoonmaak).
- VC002G/VC004G: ideaal voor stofafzuiging van machines (met HEPA filter en AWS).
- VC005G: voor algemeen droog gebruik (schoonmaak).

	VC001GLZ	VC003GLZ	VC002GLZ01	VC004GLZ01	VC005GLZ
Spanning	36 V (40Vmax)	36 V (40Vmax)	36 V (40Vmax)	36 V (40Vmax)	36 V (40Vmax)
Bijgeleverde accu's	-	-	-	-	-
Type	Droog/Nat	Droog/Nat	Droog	Droog	Droog
Capaciteit	8 l	15 l	8 l	15 l	8 l
Max. debiet	3,2 m ³ /min	3,2 m ³ /min	1,8 m ³ /min	1,8 m ³ /min	2,8 m ³ /min
Max. onderdruk	230 mbar	230 mbar	230 mbar	230 mbar	230 mbar
Filter	Textielfilter	Textielfilter	HEPA	HEPA	Textielfilter
AWS	-	-	✓	✓	-
Gewicht	8,1 - 10 kg	8,1 - 10 kg	8,3 - 10,2 kg	8,3 - 10,2 kg	7,9 - 9,8 kg
Prijs in €	excl. btw				
	incl. btw				

WAT BETEKEN L-, M- OF H-KLASSE?

Stofzuigers voor professioneel gebruik worden volgens EN60335-2-69 ingedeeld in risicoklassen:

L-klasse (Low risk) stofzuigers mogen gebruikt worden voor alle stof waarvan de toelaatbare blootstellingswaarde groter is dan 1 mg/m³. Deze stofzuigers laten minder dan 1 % van het opgezogen stof door.

M-klasse (Medium risk) stofzuigers mogen gebruikt worden voor alle stof waarvan de toelaatbare blootstellingswaarde groter is dan 0,1 mg/m³. Deze stofzuigers laten minder dan 0,1 % van het opgezogen stof door en voldoen bovendien aan een aantal bijkomende eisen, waaronder permanente debietcontrole en stofarme lediging.

H-klasse stofzuigers (High risk) moeten gebruikt worden voor stoffen waarvan de max. blootstellingswaarde < 0,1 mg/m³ bedraagt. Deze stofzuigers laten minder dan 0,005 % van het opgezogen stof door en moeten ook voldoen aan een aantal bijkomende eisen, zoals permanente debietcontrole en stofarme lediging.

Opgelet: stofzuigers zonder aanduiding van de stofklasse volgens EN60335-2-69 bieden geen enkele garantie op het vlak van persoonlijke veiligheid en zijn derhalve niet geschikt voor professioneel gebruik.

ACCU STOFZUIGERS L-KLASSE XGT



VC007GL, VC006GM: dubbel filtersysteem met automatisch zelfreinigende filter, zonder zuigkrachtonderbreking



- Accu stofzuiger met hoge zuigkracht, vergelijkbaar met model op netstroom
- Stofklasse L, met HEPA-filter
- Nat en droog gebruik, uitgerust met waterniveausensor en waterafvoer
- Automatisch zelfreinigende filter met dubbel filtersysteem
- Inclusief slang 28 mm en 38 mm, gebogen buis en vloerzuigmond
- AWS: de stofzuiger kan automatisch aangestuurd worden door AWS-compatibele powertools

		VC007GLZ01
Spanning	72 V (80Vmax)	
Bijgeleverde accu's	-	
Lader	-	
Kuipvolume	40 l	
Type	nat/droog	
Filterklasse	L (HEPA)	
Max. debiet (38 mm slang)	3,7 m ³ /min	
Max. debiet (28 mm slang)	2,0 m ³ /min	
Max. onderdruk	180 mbar	
Gewicht	18,3 - 20,7 kg	
Prijs in €	excl. btw	
	incl. btw	

ACCU STOFZUIGERS M-KLASSE XGT



De VG006GM heeft een instelling van de slangdiameter en waarschuwingszoemer voor te lage luchtstroom.



- Accu stofzuiger met hoge zuigkracht, vergelijkbaar met model op netstroom
- Stofklasse M
- Nat en droog gebruik, uitgerust met waterniveausensor en waterafvoer
- Automatisch zelfreinigende filter met dubbel filtersysteem
- Inclusief slang 28 mm en 38 mm, gebogen buis en vloerzuigmond
- AWS: de stofzuiger kan automatisch aangestuurd worden door AWS-compatibele powertools

		VC006GMZ01
Spanning	72 V (80Vmax)	
Bijgeleverde accu's	-	
Lader	-	
Kuipvolume	40 l	
Type	nat/droog	
Filterklasse	M	
Max. debiet (38 mm slang)	3,7 m ³ /min	
Max. debiet (28 mm slang)	2,0 m ³ /min	
Max. onderdruk	180 mbar	
Gewicht	18,4 - 20,8 kg	
Prijs in €	excl. btw	
	incl. btw	

STOFZUIGERS L-KLASSE

Klasse L
VC2512L

Klasse L
VC2000L

Klasse L
VC3011L

Klasse L
VC3012L

INCLUSIEF
1 SET ACCESSOIRES



STOFZUIGERS L-, M- EN H-KLASSE

Klasse L
VC2510LX1

Klasse L
VC3210LX1

Klasse M
VC3211MX1

Klasse H
VC3211HX1

INCLUSIEF
1 SET ACCESSOIRES



Automatische filterreininging
zonder zuigkrachtonderbreking.

Automatische filterreininging
zonder zuigkrachtonderbreking.

STOFZUIGERS L- EN M-KLASSE

Klasse M
VC2211MX1

Klasse L
VC4210LX

Klasse M
VC4210MX

INCLUSIEF
1 SET ACCESSOIRES



Automatische filterreininging
zonder zuigkrachtonderbreking.

Automatische filterreininging
zonder zuigkrachtonderbreking.

Automatische filterreininging
zonder zuigkrachtonderbreking.



	VC2000L	VC2012L	VC2512L	VC3011L	VC3012L	VC3012M	VC2211MX1
Nominaal vermogen	1000 W	1100 W	1100 W	1000 W	1200 W	1200 W	1050 W
Max. debiet	3,6 m³/min	3,6 m³/min	3,6 m³/min	3,6 m³/min	3,7 m³/min	3,7 m³/min	3,5 m³/min
Max. onderdruk	210 mbar	210 mbar	210 mbar	210 mbar	230 mbar	230 mbar	220 mbar
Bruto kuipvolume	20 l	19 l	23 l	30 l	30 l	30 l	22 l
Gewicht	7,5 kg	7,3 kg	6,3 kg	10,5 kg	10 kg	10 kg	16,3 kg
Prijs in €	excl. btw						
	incl. btw						

	VC2510LX1	VC3210LX1	VC3211MX1	VC3211HX1	VC4210LX	VC4210MX
Nominaal vermogen	1050 W	1050 W	1050 W	1050 W	1200 W	1200 W
Max. debiet	3,5 m³/min	3,5 m³/min	3,5 m³/min	3,5 m³/min	4,5 m³/min	4,5 m³/min
Max. onderdruk	220 mbar	220 mbar	220 mbar	220 mbar	250 mbar	250 mbar
Bruto kuipvolume	32 l	40 l	40 l	40 l	42 l	42 l
Gewicht	10,5 kg	14,5 kg	16,9 kg	16,9 kg	15 kg	15 kg
Prijs in €	excl. btw					
	incl. btw					

BOORHAMERS SDS-PLUS 2 FUNCTIES



HR1841FJ

HR2800



	HR2600	HR1841FJ	HR2800
Nominaal vermogen	800 W	470 W	800 W
Slagenergie	2,4 J	1,4 J	2,8 J
Max. Ø beton	26 mm	18 mm	28 mm
AVT	-	✓	-
Vibratieniveau hamerboren	15,5 m/s ²	7,5 m/s ²	20 m/s ²
Gewicht	2,8 kg	2,5 kg	3,4 kg
Prijs in €	excl. btw		
	incl. btw		

COMBIHAMERS SDS-PLUS 3 FUNCTIES



HR2630X7

Inclusief automatische boorkop bij HR2630X7

Inclusief Boor- en beitelset 17 stuks bij HR2630TX12 & HR2631FT12 t.w.v.



HR2631FT12



HR2470

	HR2470	HR2630X7	HR2630TX12	HR2631FT12	HR2811FT
Nominaal vermogen	780 W	800 W	800 W	800 W	800 W
Slagenergie	2,4 J	2,4 J	2,4 J	2,4 J	2,9 J
Max. Ø beton	24 mm	26 mm	26 mm	26 mm	28 mm
AVT	-	-	-	✓	-
Vibratieniveau hamerboren	15,5 m/s ²	15 m/s ²	15 m/s ²	11,5 m/s ²	15 m/s ²
Gewicht	3,0 kg	3,0 kg	2,9 kg	3,0 kg	3,6 kg
Prijs in €	excl. btw				
	incl. btw				

COMBIHAMERS SDS-PLUS MET STOFAFZUIGING



Inclusief boor- en beitelset 17 stuks bij HR2651TX12 t.w.v.



Inclusief stofafzuigingsunit DX11 bij HR3012FCWJ



HR2651TX12

HR3012FCWJ

	HR2651TX12	HR3012FCWJ
Nominaal vermogen	800 W	1050 W
Slagenergie	2,2 J	3,9 J
Max. Ø beton	26 mm	30 mm
AVT	✓	✓
Vibratieniveau hamerboren	11,5 m/s ²	9,5 m/s ²
Gewicht	4,2 kg	4,4 kg
Prijs in €	excl. btw	
	incl. btw	

COMBIHAMERS SDS-PLUS



HR3210FCT

HR3210FCT:
met anti-vibratie
handgreep

INCLUSIEF
1 automatische
boorkop (194568-7)
bij HR3210FCT



	HR3200C	HR3210FCT
Nominaal vermogen	850 W	850 W
Slagenergie	5,1 J	4,9 J
Max. Ø beton	32 mm	32 mm
AVT	-	✓
Vibratieniveau hamerboren	18 m/s ²	10 m/s ²
Gewicht	4,8 kg	5,4 kg
Prijs in €	excl. btw	
	incl. btw	

COMBIHAMERS SDS-MAX



gratis 5-delige
boor- en beitelset
P-52445 bij HR4013C, HR4511C
en HR5212C
t.w.v.

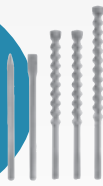

HR4013CV

CV-modellen
inclusief
stofafzuigset

	HR3541FCX	HR4013C	HR4013CV	HR4511C	HR4511CV	HR5212C
Nominaal vermogen	850 W	1100 W	1100 W	1350 W	1350 W	1500 W
Slagenergie	5,7 J	8,0 J	8,0 J	9,4 J	9,4 J	18,9 J
Max Ø beton	35 mm	40 mm	40 mm	45 mm	45 mm	52 mm
AVT	✓	✓	✓	✓	✓	✓
Vibratieniveau hamerboren	11 m/s ²	5,0 m/s ²	5,0 m/s ²	7,5 m/s ²	7,5 m/s ²	12,5 m/s ²
Gewicht	5,6 kg	6,8 kg	6,8 kg	8,8 kg	8,8 kg	12,1 kg
Prijs in €	excl. btw					
	incl. btw					

STOFAFZUIGSET VOOR BOOR-EN BREEKHAMERS

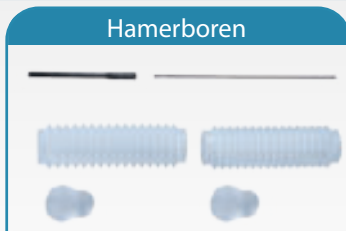

	199142-6	195866-2	196858-4
	HR4013C	HR4511C	HR5212C
Prijs in €	excl. btw		
	incl. btw		

BIKHAMERS SDS-PLUS



HK1820

	HK0500	HK1820
Nominaal vermogen	550 W	550 W
Slagfrequentie	2000-3500 /min	0-3200 /min
Slagenergie	1,8 J	3,1 J
AVT	-	-
Triaxiale vibratiewaarde (ah)	9,5 m/s ²	10 m/s ²
Gewicht	3,2 kg	3,4 kg
Prijs in €	excl. btw	
	incl. btw	

BREEKHAMERS SDS-MAX



HM1213C



HM1214C



HM0871C

PROMO
gratis 5-delige
beitelset
E-20236 bij
HM0871C



Wist u dat u tijdens de garantieperiode recht hebt op één gratis onderhoudsbeurt? Ontdek er meer over op www.makita.be

AVT
ANTI VIBRATION TECHNOLOGY

SOFT NO LOAD

CV-modellen
inclusief
stofafzuigset

	HM0870C	HM0871C	HM1101C	HM1101CV
Nominaal vermogen	1100 W	1100 W	1300 W	1300 W
Slagfrequentie	1100-2650 /min	1100-2650 /min	1100-2600 /min	1100-2600 /min
Slagenergie	7,6 J	8,1 J	11,5 J	11,5 J
AVT	-	✓	-	-
Triax. vibratie beitelen (ah)	11,5 m/s ²	8 m/s ²	13,5 m/s ²	13,5 m/s ²
Gewicht	5,1 kg	5,8 kg	7 kg	7 kg
Prijs in €	excl. btw			
	incl. btw			

	HM1111C	HM1203C	HM1213C	HM1214C
Nominaal vermogen	1300 W	1510 W	1510 W	1510 W
Slagfrequentie	1100-2600 /min	950-1900 /min	950-1900 /min	950-1900 /min
Slagenergie	11,2 J	19,1 J	18,6 J	19,9 J
AVT	✓	-	✓	✓
Triax. vibratie beitelen (ah)	8 m/s ²	15,5 m/s ²	7 m/s ²	8 m/s ²
Gewicht	7,7 kg	9,7 kg	10,8 kg	12,3 kg
Prijs in €	excl. btw			
	incl. btw			

STOFAFZUIGING BREEKHAMERS



199144-2



197168-2

		199144-2	197168-2
Geschikt voor		Breekhamers SDS-Max	HM1812 / HM1317C
Prijs in €	excl. btw		
	incl. btw		

**SOFT
NO LOAD**

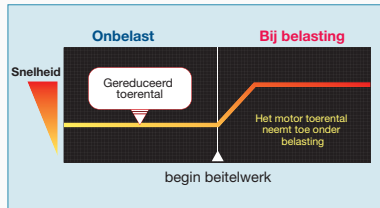

Reduceert automatisch het toerental van de machine om ongewenste trillingen verder te reduceren.

BREEKHAMERS MET ZESKANTOPNAME



**SOFT
NO LOAD** **AVT**
ANTI VIBRATION TECHNOLOGY

HM1511/HM1512:
slagenergie
48,9 J



HM1812

HM1812:
slagenergie 72,8 J

GRATIS
trolley D-54972
bij HM1812



HM1511

HM1511 / HM1512 :
Uitzonderlijk laag trillings-
niveau door anti-vibratie behuizing,
actieve trillingsdemping en de
soft-no-load regeling



	HM1317C	HM1511	HM1512	HM1812
Nominaal vermogen	1510 W	1850 W	1850 W	2000 W
Slagfrequentie	730-1450 /min	1300 /min	1300 /min	870 /min
Slagenergie	25 J	48,9 J	48,9 J	72,8 J
AVT	✓	✓	✓	✓
Triax. vibratie beetelen (ah)	8,5 m/s ²	6,5 m/s ²	6,5 m/s ²	6,5 m/s ²
Opname hex.	30 mm	30 mm	28,6 mm	28,6 mm
Gewicht	17 kg	19,2 kg	20,4 kg	31,3 kg
Prijs in €	excl. btw			
	incl. btw			

KLOPBOORMACHINES



HP2071FJ



	HP1631KSP	HP2051FHJ	HP2071FJ
Nominaal vermogen	710 W	720 W	1010 W
Toerental	0-3200 t.p.m.	0-2900 t.p.m.	0-2900 t.p.m.
Ø Max. staal	13 mm	13 mm	18 mm
Ø Max. hout	30 mm	40 mm	40 mm
Ø Max. steen	16 mm	20 mm	20 mm
Boorkop	1,5-13 mm	1,5-13 mm	1,5-13 mm
Makpac	-	✓	✓
Gewicht	2 kg	2,5 kg	2,6 kg
Prijs in €	excl. btw		
	incl. btw		

BOORMACHINES



DP4011

DP4011
Met 2 snelheden

	DP2011	DP4003	DP4011
Nominaal vermogen	370 W	750 W	720 W
Toerental	0-4200 t.p.m.	0-700 t.p.m.	0-2900 t.p.m.
Ø Max. staal	6,5 mm	13 mm	13 mm
Ø Max. hout	15 mm	38 mm	40 mm
Boorkop	0,8-6,5 mm	1,5-13 mm	1,5-13 mm
Gewicht	1,1 kg	2,4 kg	2,3 kg
Prijs in €	excl. btw		
	incl. btw		

DIAMANTKERNBOORMACHINES



DBM131W

DBM131W / DBM230W
Geleverd met boorstandaard



	DBM131	DBM131W	DBM230W
Nominaal vermogen	1700 W	1700 W	2500 W
Toerental onbelast 1	1100 t.p.m.	1100 t.p.m.	390 t.p.m.
Toerental onbelast 2	2300 t.p.m.	2300 t.p.m.	1040 t.p.m.
Toerental onbelast 3	-	-	1700 t.p.m.
Ø Max. beton	132 mm	132 mm	230 mm
Gewicht	6,1 kg	6,1 kg	6,9 kg
Prijs in €	excl. btw		
	incl. btw		

ACCESSOIRES



Diamantboren

Nieuwe beton diamantkernboren voor nat gebruik.

- Langere levensduur dankzij lasergelaste segmenten.
- Totale lengte verhoogd naar 450mm.
- Snellere boorprestatie dankzij chevron-vormige diamantdeeltjes.

Omschrijving	Best. nr..	Ø	Lengte	Opname	Stuks	Prijs excl. btw	Prijs incl. btw
Diamantkernboor	E-19869	32 mm	450 mm	1-1/4"UNC	1		
Diamantkernboor	E-19875	42 mm	450 mm	1-1/4"UNC	1		
Diamantkernboor	E-19881	52 mm	450 mm	1-1/4"UNC	1		
Diamantkernboor	E-19897	62 mm	450 mm	1-1/4"UNC	1		
Diamantkernboor	E-19906	68 mm	450 mm	1-1/4"UNC	1		
Diamantkernboor	E-19912	72 mm	450 mm	1-1/4"UNC	1		
Diamantkernboor	E-19928	82 mm	450 mm	1-1/4"UNC	1		
Diamantkernboor	E-19934	92 mm	450 mm	1-1/4"UNC	1		
Diamantkernboor	E-19940	102 mm	450 mm	1-1/4"UNC	1		
Diamantkernboor	E-19956	107 mm	450 mm	1-1/4"UNC	1		
Diamantkernboor	E-19962	112 mm	450 mm	1-1/4"UNC	1		

Omschrijving	Best. nr..	Ø	Lengte	Opname	Stuks	Prijs excl. btw	Prijs incl. btw
Diamantkernboor	E-19978	117 mm	450 mm	1-1/4"UNC	1		
Diamantkernboor	E-19984	122 mm	450 mm	1-1/4"UNC	1		
Diamantkernboor	E-19990	127 mm	450 mm	1-1/4"UNC	1		
Diamantkernboor	E-20002	132 mm	450 mm	1-1/4"UNC	1		
Diamantkernboor	E-20018	142 mm	450 mm	1-1/4"UNC	1		
Diamantkernboor	E-20024	152 mm	450 mm	1-1/4"UNC	1		
Diamantkernboor	E-20030	162 mm	450 mm	1-1/4"UNC	1		
Diamantkernboor	E-20046	172 mm	450 mm	1-1/4"UNC	1		
Diamantkernboor	E-20052	182 mm	450 mm	1-1/4"UNC	1		
Diamantkernboor	E-20068	202 mm	450 mm	1-1/4"UNC	1		
Diamantkernboor	E-20074	212 mm	450 mm	1-1/4"UNC	1		

HAAKSE BOORMACHINES

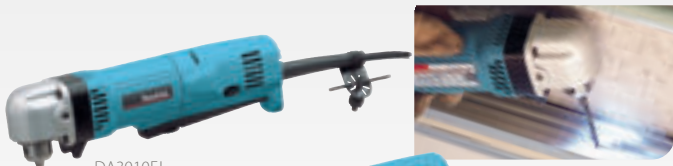

DA3010FJ

DA3011FJ

		DA3010FJ	DA3011FJ
Nominaal vermogen		450 W	450 W
Toerental		0-2400 t.p.m.	0-2400 t.p.m.
Ø Max. staal		10 mm	10 mm
Ø Max. hout		25 mm	25 mm
Boorkop		1-10 mm	1-10 mm
Gewicht		1,6 kg	1,6 kg
Prijs in €	excl. btw		
	incl. btw		

KERNBOORMACHINE MET MAGNEETVOET



		HB350	HB500
Nominaal vermogen		1050 W	1150 W
Toerental onbelast 1		450 t.p.m.	350 t.p.m.
Toerental onbelast 2		850 t.p.m.	650 t.p.m.
Ø Max. staal		35 mm	50 mm
Klemkracht magneetvoet		8000 N	9300 N
Opname		3/4" WELDON	3/4" WELDON
Gewicht		11,5 kg	18,5 kg
Prijs in €	excl. btw		
	incl. btw		

MENGRS



UT1600

		UT1400	UT1401	UT1600
Nominaal vermogen		1300 W	1300 W	1800 W
Toerental onbelast 1		0-900 t.p.m.	0-400 t.p.m.	0-440 t.p.m.
Toerental onbelast 2		-	0-730 t.p.m.	0-970 t.p.m.
Toerental belast max.		0-580 t.p.m.	0-450 t.p.m.	0-580 t.p.m.
Schroefdraad spindel		M14	M14	M14
Gewicht		5,2 kg	5,5 kg	7,1 kg
Prijs in €	excl. btw			
	incl. btw			

BOORMACHINE / MENGERS



DS4012

Nominaal vermogen		750 W
Toerental		600 t.p.m.
Ø Max. staal		13 mm
Ø Max. hout		36 mm
Boorkop		2-13 mm
Gewicht		2,8 kg
Prijs in €	excl. btw	
	incl. btw	

SCHROEFAUTOMATEN



6843J

		6844	6843J
Nominaal vermogen		470 W	470 W
Toerental		3000 t.p.m.	6000 t.p.m.
Ø gipsplaatschroef		3,5 - 4,0 mm	3,5 - 4,0 mm
Schroeflengte		45-75 mm	25-55 mm
Verpakking		Koffer	Makpac
Gewicht		2 kg	2 kg
Prijs in €	excl. btw		
	incl. btw		

SCHROEFMACHINES VOOR GIPSPLAAT



FS2500K: met 1/4" Hex bitopname



FS2500



FS2701K

FS2701K: met koppelinstelling (6 stappen)



schroeflintadapter 191L24-0

		FS2300K	FS2500K	FS2701K	FS4000JX2	FS6300RJX2
Nominaal vermogen		570 W	570 W	570 W	570 W	570 W
Toerental		0-2500 t.p.m	0-2500 t.p.m	0-2500 t.p.m	0-4000 t.p.m.	0-6000 t.p.m.
Ø gipsplaatschroef		5 mm	5 mm	5 mm	5 mm	5 mm
Incl. schroeflintadapter		-	-	-	✓	✓
Gewicht		1,7 kg	1,6 kg	1,7 kg	1,3 kg	1,4 kg
Prijs in €	excl. btw					
	incl. btw					

HETELUCHTPISTOLEN



HG6531CK



HG5030K

	HG5030K	HG6031VK	HG6531CK
Vermogen	1600 W	1800 W	2000 W
Temperatuurbereik	350-500 °C	50-600 °C	50-650 °C
Temperatuurinstelling	2 niveaus	9 niveaus	Elektronisch in stappen van 5°C
Debiet	300 / 500 l/min	250 / 500 l/min	200 / 550 l/min
Gewicht	0,56 kg	0,67 kg	0,71 kg
Prijs in €	excl. btw		
	incl. btw		

SLAGMOERSLEUTELS



TW0200J
TW0350J
6906J

TW0350J

	TW0200J	TW0350J	6906J	TW1000
Nominaal vermogen	380 W	400 W	650 W	1300 W
Max. koppel	200 Nm	350 Nm	588 Nm	1000 Nm
Bitopname	1/2" vierkant	1/2" vierkant	3/4" vierkant	1" vierkant
Gewicht	2,2 kg	3 kg	5,6 kg	8,6 kg
Prijs in €	excl. btw			
	incl. btw			

KNABELSCHAREN



JN3201J

	JN1601	JN3201J
Nominaal vermogen	550 W	710 W
Max. dikte staal	1,6 mm	3,2 mm
Gewicht	1,6 kg	3,4 kg
Prijs in €	excl. btw	
	incl. btw	

PLAATSCHAREN



JS1602J

	JS1601J	JS1602J	JS3201J
Nominaal vermogen	380 W	380 W	710 W
Aantal zaagbewegingen	4500 /min	4000 /min	1600 /min
Max. dikte staal	1,6 mm	1,6 mm	3,2 mm
Gewicht	1,4 kg	1,6 kg	3,4 kg
Prijs in €	excl. btw		
	incl. btw		

METAALCIRKELZAAG



4131

	4131
Nominaal vermogen	1100 W
Toerental	3500 t.p.m.
Zaagdiepte (90°)	63 mm
Ø Zaagblad	185 mm
Gewicht	5,1 kg
Prijs in €	excl. btw
	incl. btw

GROEFFREES



Voor aluminium / composiet platen

	CA5000XJ
Nominaal vermogen	1300 W
Toerental	2200-6400 t.p.m.
Ø Zaagblad	118 mm
Gewicht	5,1 kg
Prijs in €	excl. btw
	incl. btw

COMFORTABEL WERKEN MET SUPER JOINT SYSTEM II

Zonder SJS

Bladveer absorbeert trillingen en vermindert schokken tijdens het werken

HAAKSE SLIJPER 125 MM

		GA5034	GA5030RK	GA5030RSP2
Nominaal vermogen		720 W	720 W	720 W
Toerental		11000 t.p.m.	11000 t.p.m.	11000 t.p.m.
Ø schijf		125 mm	125 mm	125 mm
Dodemansschakelaar		✓	-	-
Gewicht		1,9 kg	1,8 kg	1,8 kg
Prijs in €	excl. btw			
	incl. btw			

HAAKSE SLIJPER 115 MM

GA4530RK

		GA4530RK
Nominaal vermogen		720 W
Toerental		11000 t.p.m.
Ø schijf		115 mm
Gewicht		1,8 kg
Prijs in €	excl. btw	
	incl. btw	

HAAKSE SLIJPER 125 MM

9558HNRGK3:
geleverd met
1 afbraamschijf en
2 diamantschijven

9558PBGY met dodemansschakelaar: motor schakelt uit bij loslaten van schakelaar voor verhoogde veiligheid

		9558HNRGZ	9558PBGY	9558HNRGK3
Nominaal vermogen		840 W	840 W	840 W
Toerental		11000 t.p.m.	11000 t.p.m.	11000 t.p.m.
Ø schijf		125 mm	125 mm	125 mm
Dodemansschakelaar		-	✓	-
Gewicht		2,1 kg	2,1 kg	2,1 kg
Prijs in €	excl. btw			
	incl. btw			

HAAKSE SLIJPER 125 MM X-LOCK



X-LOCK
Snel en veilig schijven bevestigen via een kliksysteem.



GA5080RX03

GA5080RX03

Nominaal vermogen	1400 W
Toerental	12000 t.p.m.
Ø schijf	125 mm
Verpakking	Makpac
Gewicht	2,5 – 3,6 kg
Prijs in €	excl. btw
	incl. btw

HAAKSE SLIJPERS 125 MM



GA5041CT01

GA5040CJD1



GA5041CT01
met mechanische motorrem,
instelbaar toerental, Ezynut & AVT-grip

SA5040C Traagdraaiend

	GA5040RZ	GA5040RKDJ	GA5040C	GA5040CJD	GA5040CJD1	GA5041RZ	GA5041CT01	SA5040C
Nominaal vermogen	1100 W	1100 W	1400 W	1400 W	1400 W	1100 W	1400 W	1400 W
Toerental	11000 t.p.m.	11000 t.p.m.	2800-11000 t.p.m.	2800-11000 t.p.m.	2800-11000 t.p.m.	11000 t.p.m.	2700-11000 t.p.m.	2000-7800 t.p.m.
Heropstartbeveiliging	✓	✓	✓	✓	✓	✓	✓	✓
Mechanische rem	-	-	-	-	-	✓	✓	-
Type schakelaar	Schuifschakelaar met vergrendeling	Schuifschakelaar met vergrendeling	Schuifschakelaar met vergrendeling	Schuifschakelaar met vergrendeling	Schuifschakelaar met vergrendeling	Schuifschakelaar met vergrendeling	Schuifschakelaar met vergrendeling	Schuifschakelaar met vergrendeling
Verpakking	Karton	Makpac	Karton	Makpac	Makpac	Karton	Karton	Karton
Gewicht	2,4 kg	2,4 kg	2,4 kg	2,4 kg	2,7 kg	2,4 kg	2,7 kg	2,2 kg
Meegeleverde accessoires	-	2 x diamantschijf	-	2 x diamantschijf	1 x diamantschijf + beschermkap stofafzuiging	-	AVT-greep + Ezynut sluitmoer	-
Prijs in €	excl. btw							
	incl. btw							

HAAKSE SLIJPERS 125 MM / 150 MM



9565PCV01

9565PCV01 & 9566PCV01: Antivibratiehandgreep en dodemansschakelaar.



GA5050R: grote lepelschakelaar + gereedschapsloze beschermkap

	GA5050R	9565CRX1	9565PCV01	9566PCV01	GA6040C
Nominaal vermogen	1300 W	1400 W	1400 W	1400 W	1400 W
Toerental	11000 t.p.m.	11000 t.p.m.	2800-11500 t.p.m.	4000-10000 t.p.m.	4000-9000 t.p.m.
SJS	-	✓	✓	✓	✓
Ø schijf	125 mm	125 mm	125 mm	150 mm	150 mm
Type schakelaar	Lepelschakelaar zonder vergrendeling	Schuifschakelaar met vergrendeling	Lepelschakelaar zonder vergrendeling	Lepelschakelaar zonder vergrendeling	Schuifschakelaar met vergrendeling
Gewicht	2,5 kg	2,6 kg	2,6 kg	2,7 kg	2,6 kg
Prijs in €	excl. btw				
	incl. btw				

HAAKSE SLIJPERS 125 MM



GA5021CY

GA5021CYX1:
Inclusief antivibratiegreep en Ezynut sluitmoer

	GA5021C	GA5021CY	GA5021CYX1
Nominaal vermogen	1450 W	1450 W	1450 W
Toerental	10000 t.p.m.	10000 t.p.m.	10000 t.p.m.
Ø schijf	125 mm	125 mm	125 mm
Dodemansschakelaar	-	✓	✓
Gewicht	3 kg	3 kg	3 kg
Prijs in €	excl. btw		
	incl. btw		

10x
Doorslijpschijven
in blik



Ref.	Ø (mm)	Dikte (mm)	Ø asgat (mm)	Prijs	
				excl. btw	incl. btw
D-18770-10	125	1,2	22,23		

HAAKSE SLIJPERS 125 MM

- Bestand tegen langdurige hoge belasting dankzij verbeterde koeling
- Greepomtrek van slechts 205 mm
- Mechanische rem (GA5091, GA5093, GA5094)
- De AFT functie stopt de motor ogenblikkelijk wanneer de schijf blokkeert



	GA5092X01	GA5090X01	GA5091X01	GA5095X01	GA5094	GA5093X01
Nominaal vermogen	1900 W	1900 W	1900 W	1900 W	1900 W	1900 W
Toerental	11500 min ⁻¹	2800-11500 min ⁻¹	2800-11500 min ⁻¹	11500 min ⁻¹	11500 min ⁻¹	2800-11500 min ⁻¹
Variabel toerental	-	✓	✓	-	-	✓
Mechanische rem	-	-	✓	-	✓	✓
Type Schakelaar	Schuifschakelaar	Schuifschakelaar	Schuifschakelaar	Lepelschakelaar	Lepelschakelaar	Lepelschakelaar
Dodemansschakelaar	-	-	-	✓	✓	✓
Gewicht	2,6 - 3,8 kg	2,6 - 3,8 kg	2,8 - 4,0 kg	2,7 - 3,8 kg	2,9 - 4,0 kg	2,9 - 4,0 kg
Prijs in €	excl. btw					
	incl. btw					

ACCESSOIRES

	Omschrijving	Artikel	Diameter	Dikte	Asgat	Reductiering	Specificatie	Hoogte segment	Verpakkings-eenheid	Prijs excl. btw	Prijs incl. btw
	Doorslijpschijf staal	P-53023	125 mm	1,0 mm	22,23 mm		A60R-BF		1		
	Doorslijpschijf inox	P-53045	125 mm	1,0 mm	22,23 mm		A60S-BF		1		
	Doorslijpschijf inox 'Fast cutting'	B-45733	125 mm	0,8 mm	22,23 mm		Z60T-BF		1		
	Doorslijpschijf inox 'Fast cutting'	B-45733-12	125 mm	0,8 mm	22,23 mm		Z60T-BF		12		
	Diamantschijf Comet	B-12778	125 mm	2,0 mm	22,23 mm	20 mm		10 mm	1		
	Doorslijpschijf staal	P-05773	230 mm	2,5 mm	22,23 mm		A30S4-BF		1		
	Doorslijpschijf inox	E-13764	230 mm	1,9 mm	22,23 mm		A60U-BF		1		
	Diamantschijf Comet	B-12784	230 mm	2,6 mm	22,23 mm			10 mm	1		

HAAKSE SLIJPERS 180 MM



	GA7050	GA7060	GA7082	GA7070X1	GA7070YX1
Nominaal vermogen	2000 W	2200 W	2800 W	2800 W	2800 W
Toerental	8500 t.p.m.	8500 t.p.m.	8500 t.p.m.	8500 t.p.m.	8500 t.p.m.
Dodemansschakelaar	✓	✓	-	-	✓
Draaibare achterhandgreep	-	-	-	✓	✓
Mechanische rem	-	-	-	✓	✓
Gewicht	4,5 kg	5,3 kg	6,0 kg	6,2 - 6,7 kg	6,1 - 6,6 kg
Prijs in €	excl. btw				
	incl. btw				

HAAKSE SLIJPERS 230 MM



GA9061R



GA9082



GA9060KD

Incl. diamantschijf

	GA9050	GA9060	GA9060KD	GA9082	GA9061R
Nominaal vermogen	2000 W	2200 W	2200 W	2700 W	2200 W
Toerental	6600 t.p.m.	6600 t.p.m.	6600 t.p.m.	6600 t.p.m.	6600 t.p.m.
Soft start	-	-	-	✓	✓
Dodemansschakelaar	✓	✓	✓	-	-
Draaibare achterhandgreep	-	-	-	-	-
Heropstartbeveiliging	-	-	-	-	✓
Gewicht	4,7 kg	5,6 kg	5,6 kg	6,1 kg	5,7 kg
Prijs in €	excl. btw				
	incl. btw				



HAAKSE SLIJPERS 230 MM



GA9040RF01



GA9030SF01



GA9070YX1



GA9071YX1:
Met gesloten handgreep

	GA9030SF01	GA9030RF01	GA9040SF01	GA9040RF01	GA9080X1	GA9070X1	GA9070YX1	GA9071X1	GA9071YX1
Nominaal vermogen	2400 W	2400 W	2600 W	2600 W	2700 W	2800 W	2800 W	2800 W	2800 W
Toerental	6600 t.p.m.	6600 t.p.m.	6600 t.p.m.	6600 t.p.m.	6600 t.p.m.	6600 t.p.m.	6600 t.p.m.	6600 t.p.m.	6600 t.p.m.
Dodemansschakelaar	✓	-	✓	-	-	-	✓	-	✓
Draaibare achterhandgreep	✓	✓	✓	✓	✓	✓	✓	✓	✓
Antivibratie zijhandgreep	✓	✓	✓	✓	-	✓	✓	✓	✓
Soft start	✓	✓	✓	✓	✓	✓	✓	✓	✓
Heropstartbeveiliging	-	✓	-	✓	✓	✓	✓	✓	✓
Mechanische rem	-	-	-	-	-	✓	✓	✓	✓
Gewicht	6,3 kg	6,5 kg	6,7 kg	6,9 kg	6,4 kg	6,3 kg	6,3 - 8,5 kg	6,4 kg	6,3 - 8,5 kg
Prijs in €	excl. btw								
	incl. btw								

STEMPELSLIJERS



GS5000



GD0810C



GD0811C



GD0603

	GD0600	GD0603	GD0800C	GD0810C	GD0801C	GD0811C	GS5000
Nominaal vermogen	400 W	240 W	750 W	750 W	750 W	750 W	750 W
Toerental	25000 t.p.m.	28000 t.p.m.	7000-28000 t.p.m.	1800-7000 t.p.m.	7000-28000 t.p.m.	1800-7000 t.p.m.	5600 t.p.m.
Ø spantang - bereik	6 mm	6 mm	6-8 mm	6-8 mm	6-8 mm	6-8 mm	20 mm
Ø spantang - inbegrepen	6 mm	6 mm	6 mm	6 mm	6 mm	6 mm	20 mm
Lepelschakelaar	✓	-	-	-	✓	✓	-
Dodemans	-	-	-	-	✓	✓	✓
Gewicht	1,7 kg	0,97 kg	1,7 kg	1,7 kg	1,7 kg	2,0 kg	5,0 kg
Prijs in €	excl. btw						
	incl. btw						

COMBOPACK SLIJERS



GA9060

125 mm

230 mm

9558HNRG

DK0047GX1 DK0046X1

Haakse slijper 230 mm	GA9060	GA9061R
Haakse slijper 125 mm	9558HNRG	GA5040RZ
Diamantschijf	2 x Diamak DS	2 x Diamak DS
Synthetische koffer	✓	✓
Prijs in €	excl. btw	
	incl. btw	

COMBOPACK KLOPBOORMACHINE + HAAKSE SLIJER



DK0050X1

Klopboormachine 710 W	HP1631
Haakse slijper 125 mm	GA5030R
Borensset	D-08660
Synthetische koffer	✓
Prijs in €	excl. btw
	incl. btw

COMBOPACK SCHUURMACHINE + STOFZUIGER



DK6525

Schuurmachine	BO6050J
Stofzuiger	VC2510LX1
Prijs in €	excl. btw
	incl. btw

METAALAFKORTMACHINES

LC1230N

- Inclusief HM zaagblad
- verstekhoek instelbaar op 45°



LW1400X



LC1230N

	LW1400X	LC1230N
Nominaal vermogen	2200 W	1750 W
Type schijf	doorslijpschijf	zaagblad
Toerental	3800 t.p.m.	1300 t.p.m.
Zaagdiepte (90°)	115 mm	100 mm
Ø Zaagblad	355 mm	305 mm
Gewicht	17,2 kg	19,3 kg
Prijs in €	excl. btw	
	incl. btw	

BETONSCHAVEN

PC5001C
Geleverd met komschijf B-12289



PC50001C

PC5010C

PC5010C:
Instelbaar toerental

	PC5010C	PC5001C
Nominaal vermogen	1400 W	1400 W
Ø schijf	125 mm	125 mm
Gewicht	2,5 kg	5,1 kg
Prijs in €	excl. btw	
	incl. btw	

MUURFREZEN



SG150



SG181

	SG1251J	SG150	SG181
Nominaal vermogen	1400 W	1800 W	2150 W
Max. slijpdiepte	30 mm	45 mm	60 mm
Sleufbreedte	6-30 mm	7-35 mm	7-43 mm
Ø schijf	125 mm	150 mm	180 mm
Gewicht	4,4 kg	5,7 kg	6 kg
Prijs in €	excl. btw		
	incl. btw		

DIAMANTZAAG



4114S

Nominaal vermogen	2400 W
Max. slijpdiepte	125 mm
Ø schijf	350 mm
Ø asgat	25,4 mm
Gewicht	10,8 kg
Prijs in €	excl. btw
	incl. btw

DIAMANTZAAG



4100KB

Nominaal vermogen	1400 W
Zaagdiepte (90°)	40 mm
Ø Zaagblad	125 mm
Gewicht	3,0 kg
Prijs in €	excl. btw
	incl. btw



MOTORDOORSLIJPERS



EK6100

		EK6100
Motor		2-takt
Cilinderinhoud		60,7 cc
Vermogen		3,2 kW / 4,3 pk
Maximaal nettokoppel		3,9 Nm
Ø schijf		300 mm
Decompressieklep		-
Gewicht		8,5 kg
Prijs in €	excl. btw	
	incl. btw	

DIAMANTSCHIJVEN

	Artikel	Ø	Dikte	Hoogte segment	Ø asgat	Reductiering	Prijs excl. btw	Prijs incl. btw
Quasar	 B-17588	300 mm	3,0 mm	12 mm	25,4 mm	20 mm		
	B-13465	350 mm	3,0 mm	12 mm	25,4 mm	20 mm		
	B-13471	400 mm	3,0 mm	12 mm	25,4 mm	20 mm		
Comet	 B-17619	300 mm	3,0 mm	10 mm	25,4 mm	20 mm		
	B-13552	350 mm	3,0 mm	10 mm	25,4 mm	20 mm		
	B-13568	400 mm	3,0 mm	10 mm	25,4 mm	20 mm		
Asfalt	 B-13275	350 mm	3,2 mm	10 mm	25,4 mm	20 mm		
	B-42905	400 mm	3,2 mm	10 mm	25,4 mm	20 mm		
Reductieringen	Artikel	Ø extern	Ø intern	Dikte	Prijs excl. btw	Prijs incl. btw		
	257199-4	22,23 mm	20,00 mm	3,0 mm				
	197318-9	25,4 mm	20,00 mm	5 mm				

SLIJPMOLENS



GB801



	GB602W	GB801
Nominaal vermogen	250 W	550 W
Toerental	2850 t.p.m.	2850 t.p.m.
Ø Slijpsteen	150 mm	205 mm
Gewicht	9 kg	19,8 kg
Prijs in €	excl. btw	
	incl. btw	

LINTZAAGMACHINE



B-42581
Schuurbanden 20 x 2240 mm
Rood • Korrel 80

B-42597
Schuurbanden 20 x 2240 mm
Rood • Korrel 120

JM21000330
Adapterset voor schuurbanden

		LB1200F
Nominaal vermogen		900 W
Breedte zaaglint		6-16 mm
Gewicht		81,2 kg
Prijs in €	excl. btw	
	incl. btw	

RECIPROZAGEN



JR3070CT

		JR3051TK	JR3061T	JR3070CT
Nominaal vermogen		1200 W	1250 W	1510 W
Aantal zaagbewegingen		0-3000 /min	0-2800 /min	0-2800 /min
AVT		-	-	✓
Pendelinstelling		-	-	✓
Slaglengte		30 mm	32 mm	32 mm
Vibratieniveau		19,5 m/s ²	23,5 m/s ²	8,5 m/s ²
Gewicht		3,2 kg	4,4 kg	4,4 kg
Prijs in €	excl. btw			
	incl. btw			

LAMELLENFREES



Aanslagplaat met tandheugelverstelling voor een snelle en precieze aanpassing aan de materiaaldikte.

Revolver diepte-instelling met 6 preselecties voor een snelle afstelling.



Kantelbare voetplaat met handige vergrendelingshendel en automatische stops op 0°, 45° en 90°.

		PJ7000J
Nominaal vermogen		700 W
Toerental		11000 t.p.m.
Ø zaagblad		100 mm
Asgat		22 mm
Gewicht		2,5 kg
Prijs in €	excl. btw	
	incl. btw	

MULTITOOL



INCLUSIEF:
Set van 9 accessoires,
30 schuurvellen en 1 afzuigset



GEREEDSCHAPSLOZE
ACCESSOIREWISSEL

		TM3010CX3J
Nominaal vermogen		320 W
Oscillatiefrequentie		6000-20000/min
Oscillatiehoek		3,2°
Gewicht		1,6 kg
Prijs in €	excl. btw	
	incl. btw	

VANDIKTEBANK



		2012NB
Nominaal vermogen		1650 W
Toerental		8500 t.p.m.
Breedte		304 mm
Max. doorlaathoogte		155 mm
Max. spaanafname		3 mm
Gewicht		28,1 kg
Prijs in €	excl. btw	
	incl. btw	

KETTINGFREZEN



		7104L	7104L-30
Nominaal vermogen		1140 W	1140 W
Toerental		3200 t.p.m.	3200 t.p.m.
Kettingsnelheid onbelast		5 m/s	5 m/s
Ketting		16,5 mm	30 mm
Gatbreedte		16,5-30 mm	30-45 mm
Gatlengte		54-130 mm	54-130 mm
Gewicht		17,3 kg	17,3 kg
Prijs in €	excl. btw		
	incl. btw		

BOVENFREZEN



RP1111CJ



RP2302FC07

RP2302FC07: Inclusief langsgelieder met fijnafstelling

	RP0900J	RP1111CJ	RP1802F	RP2302FC07
Nominaal vermogen	900 W	1100 W	1850 W	2300 W
Toerental	27000 t.p.m.	8000 - 27500 t.p.m.	23000 t.p.m.	9000-22000 t.p.m.
Max. induikdiepte	35 mm	57 mm	70 mm	70 mm
Ø Spantang - bereik	6-8 mm	6-8 mm	6-12 mm	6-12 mm
Ø Spantang - inbegrepen	8 mm	8 mm	6, 8, 12 mm	6, 8, 12 mm
Verpakking	Makpac	Makpac	Karton	Makpac
Gewicht	2,7 kg	3,3 kg	6,2 kg	6,1 kg
Prijs in €	excl. btw			
	incl. btw			

KANTENFREZEN



3711



3712

3712: Inclusief kantelbare zool

	3711	3712
Nominaal vermogen	530 W	530 W
Toerental	32000 t.p.m.	32000 t.p.m.
Max. induikdiepte	42 mm	42 mm
Spantang	6 mm	6 mm
Gewicht	1,5 kg	1,7 kg
Prijs in €	excl. btw	
	incl. btw	

BOVEN- EN KANTENFREES



4 MACHINES IN 1

- Rechte kantenfrees
- Verstelbare kantenfrees
- Kantenfrees met verschoven spindel
- Bovenfrees

Rechte kantenfrees
Regelbare freesdiepte van 0 tot 40 mm

Verstelbare kantenfrees
Hoekinstelling tussen -30° en 45°

Kantenfrees met verschoven spindel om zo dicht mogelijk tegen een obstakel te werken

Bovenfrees
Diepteregeling per 1/10 van een mm van 0 tot 35 mm

RT0702CX3J

Nominaal vermogen	710 W
Toerental	10000-30000 t.p.m.
Max. induikdiepte	35 mm
Ø Spantang - bereik	6 - 8 mm
Ø Spantang - inbegrepen	6 mm, 8 mm
Gewicht	1,8 kg
Prijs in €	excl. btw
	incl. btw

SCHAVEN



KP0810CJ

	KP0800J	KP0810J	KP0810CJ	1100	1911BJ	1806B	KP312S
Nominaal vermogen	620 W	850 W	1050 W	950 W	900 W	1200 W	2200 W
Toerental	17000 t.p.m.	16000 t.p.m.	12000 t.p.m.	16000 t.p.m.	16000 t.p.m.	18000 t.p.m.	12000 t.p.m.
Breedte	82 mm	82 mm	82 mm	82 mm	110 mm	170 mm	312 mm
Max. spaanafname	2,5 mm	4 mm	4 mm	3 mm	2 mm	2 mm	3,5 mm
Gewicht	2,6 kg	3,3 kg	3,4 kg	5,1 kg	4,3 kg	9,0 kg	18,4 kg
Prijs in €	excl. btw						
	incl. btw						

DECOUPEERZAGEN



4350FCTJ



4351FCTJ



JV0600J



4329K



	4326	4329K	JV0600J	4350FCTJ	4351FCTJ
Nominaal vermogen	450 W	450 W	650 W	720 W	720 W
Aantal zaagbewegingen	3100 /min	500-3100 /min	500-3100 /min	800-2800 /min	800-2800 /min
Max. capaciteit hout	65 mm	65 mm	90 mm	135 mm	135 mm
Makpac	-	-	✓	✓	✓
Gewicht	1,8 kg	1,9 kg	2,4 kg	2,6 kg	2,5 kg
Prijs in €	excl. btw				
	incl. btw				

COMBOPACK

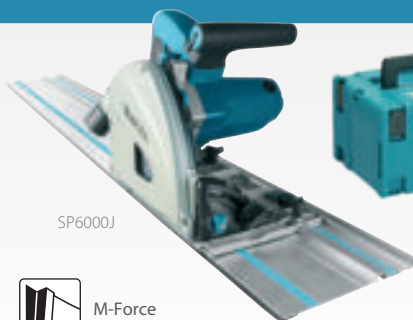

SP6000J



M-Force



4351FCTJ

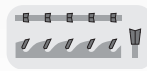

MEU029J

Invalcirkelzaag	SP6000J
Decoupeerzaag	4351FCTJ
Geleiderail 1400 mm	194368-5
Extra cirkelzaagblad	B-32007
Decoupeerzaagbladen	5
Draagtas	B-57613
Prijs in €	excl. btw
	incl. btw

INVALCIRKELZAAG



Bij model SP6000J1
2 x geleiderail 1,4 m
+ koppelstrips



	SP6000J	SP6000J1
Nominaal vermogen	1300 W	1300 W
Zaagdiepte (90°)	57 mm	57 mm
Zaagdiepte (45°)	40 mm	40 mm
Max. zaagdiepte (48°)	38 mm	38 mm
Ø Zaagblad	165 mm	165 mm
Gewicht	4,4 kg	4,4 kg
Prijs in €	excl. btw	
	incl. btw	

CIRKELZAGEN



5008MGJX



Zaagblad
gratis bij
5008MGJX
t.w.v.



HS7101JX



2 x zaagblad 12 tanden
bij HS7101JX t.w.v.
2 x zaagblad 16 tanden bij
5903RKX1 t.w.v.



HS0600



5143R

	HS6601	HS6101J	HS7601J	HS7101JX	5008MGJX	5903RKX1	HS0600	5103R	5143R
Nominaal vermogen	1050 W	1100 W	1200 W	1400 W	1800 W	2000 W	2000 W	2100 W	2200 W
Zaagdiepte (90°)	54,5 mm	54,5 mm	66 mm	67 mm	75,5 mm	85 mm	101 mm	100 mm	130 mm
Ø Zaagblad	165 mm	165 mm	190 mm	190 mm	210 mm	235 mm	270 mm	270 mm	355 mm
Gewicht	3,7 kg	3,7 kg	4,0 kg	4,0 kg	5,1 kg	7,2 kg	6,9 kg	9,4 kg	14,0 kg
Prijs in €	excl. btw								
	incl. btw								

TAFEL-, AFKORT- EN VERSTEKZAGEN



LF1000



LF1000



LH1201FL

SNELLE OMBOUW
VAN TAFEL- NAAR
AFKORTZAAGFUNCTIE

	LH1040	LH1201	LF1000
Verstekhoek	90°	45°	90°
90°	91 x 95 mm 69 x 130 mm	95 x 155 mm 62 x 200 mm	68 x 155 mm 20 x 180 mm
45°	69 x 85 mm	62 x 125 mm	50 x 150 mm

	LH1040F	LH1201FL	LF1000
Nominaal vermogen	1650 W	1650 W	1650 W
Ø Zaagblad	260 mm	305 mm	260 mm
Gewicht	14,3 kg	20,7 kg	36 kg
Prijs in €	excl. btw		
	incl. btw		

AFKORT-VERSTEKZAAG



Kantelbaar naar links tot 45°

	LS1040N	
Nominaal vermogen	1650 W	
Ø Zaagblad	260 mm	
Max. zaagdiepte 0°	91 x 95 mm	
Max. zaagdiepte 45°	91 x 67 mm	
Gewicht	12,4 kg	
Prijs in €	excl. btw	
	incl. btw	

TAFELZAAG MET ONDERSTEL



	2704NX1	
Nominaal vermogen	1650 W	
Ø Zaagblad	260 mm	
Gewicht	34,9 kg	
Prijs in €	excl. btw	
	incl. btw	

TAFELZAAG



	MLT100N	
Nominaal vermogen	1500 W	
Ø Zaagblad	260 mm	
Gewicht	34,7 kg	
Prijs in €	excl. btw	
	incl. btw	



BOUWCIRKELZAAG



	2712	
Nominaal vermogen	2000 W	
Ø Zaagblad	315 mm	
Gewicht	52,9 kg	
Prijs in €	excl. btw	
	incl. btw	

TELESCOPISCHE AFKORT-VERSTEKZAGEN

PROMO

Gratis onderstel DEBWST06 t.w.v. bij LS1019L/LS1219L

Model	DEBWST06 - Onderstel
LS1019	✓ 
LS1219	✓ 

Max. lengte: 2550 mm

Nieuwe bevestigingsklemmen voor het bevestigen van verstekzagen op onderstellen DEBWST06 en DEAWST07



JM00000219

DXT

Deep and Exact Cutting Technology

De gepatenteerde constructie met drievoudige tandwieloverbrenging en uitsparing achter de flens laat toe om een groter deel van het zaagblad te benutten. Daardoor kunnen ook hoge plinten verticaal of in verstek afgekort worden.



LS1019L

LS1018L

Verstekhoek	LS1219L - Snijhoek		
	45° links	0°	45° rechts
0°	71x363 mm	107x363 mm	54x363 mm
45° L EN R	71x255 mm	107x255 mm	54x255 mm
60° L EN R	-	107x178 mm	-
PLINTEN	-	171 mm	-

Verstekhoek	LS1019L - Snijhoek		
	45° links	0°	45° rechts
0°	61x279 mm	91x279 mm	43x279 mm
45° L EN R	61x197 mm	91x197 mm	43x197 mm
60° L EN R	-	91x139 mm	-
PLINTEN	-	133 mm	-

Verstekhoek	LS0815FL - Snijhoek		
	45° links	0°	5° rechts
0°	50x305 mm	65x305 mm	60x305 mm
45° L EN R	50x215 mm	65x215 mm	-
60° R	-	65x150 mm	-

Verstekhoek	LS1018LN - Snijhoek		
	45° links	90°	45° rechts
0°	50x310 mm	91x310 mm	31x310 mm
45° L EN R	50x220 mm	91x220 mm	31x220 mm
60° R	-	91x153 mm	-

Verstekhoek	LS0714FLB - Snijhoek		
	45° links	90°	45° rechts
0°	40x300 mm	52x300 mm	40x300 mm
45° L EN R	40x212 mm	52x212 mm	-
57° R	-	52x163 mm	-

	LS0815FLN	LS1018LN	LS0714LN	LS1019L	LS1219L
Nominaal vermogen	1400 W	1430 W	1010 W	1510 W	1800 W
Ø zaagblad	216 mm	260 mm	190 mm	260 mm	305 mm
DXT	-	-	-	✓	✓
Gewicht	14,2 kg	19,9 kg	13,4 kg	26,3 kg	29,5 kg
Prijs in €	excl. btw				
	incl. btw				

ONDERSTEL AFKORT-VERSTEKZAGEN



Verbeterde bevestigingsklemmen!

- Ideaal voor het zagen van lange materialen
- Vernieuwde bevestigingsklemmen met een veilig en handig kliksysteem om moeiteloos verstekzagen te installeren en te demonteren.
- Gemakkelijk te transporteren

		DEAWST07
Afmetingen		1765 (l) x 750 (b) x 850 (h) mm
Max. lengte		3830 mm
Prijs in €	excl. btw	
	incl. btw	

HANDPALMVLAKSCHUURMACHINES



	BO4556K	BO4555K	BO4558	BO4565K
Nominaal vermogen	200 W	200 W	200 W	200 W
Afmetingen schuurvoet	112 x 102 mm	112 x 102 mm	112 x 102 mm	112 x 190 mm
Bevestiging	Klem	Velcro & klem	Klem	Velcro Driehoekspunt
Materiaal schuurvoet	Kunststof	Kunststof	Aluminium	Kunststof
Aantal schuurbewegingen	14000/min	14000/min	14000/min	14000/min
Schuuruitslag	1,5 mm	1,5 mm	1,5 mm	1,5 mm
Gewicht	1,1 kg	1,1 kg	1,2 kg	1,2 kg
Prijs in €	excl. btw			
	incl. btw			



VLAKSCHUURMACHINES MET VARIABLE SNELHEID



	BO3711	BO4900VJ
Nominaal vermogen	190 W	330 W
Afmetingen schuurvoet	93 x 185 mm	115 x 232 mm
Aantal schuurbewegingen	4000-11000/min	4000-10000/min
Schuuruitslag	2,0 mm	2,6 mm
Gewicht	1,6 kg	2,7 kg
Prijs in €	excl. btw	
	incl. btw	

BANDSCHUURMACHINES



	9911J	9924DB	9903J	9031	9032	9920J	9404J	9403J
Nominaal vermogen	650 W	850 W	1010 W	550 W	500 W	1010 W	1010 W	1200 W
Bandsnelheid	75-270 m/min	400 m/min	210-440 m/min	200-1000 m/min	300-1700 m/min	210-440 m/min	210-440 m/min	500 m/min
Schuurband	75 x 457 mm	75 x 610 mm	75 x 533 mm	30 x 533 mm	9 x 533 mm	75 x 610 mm	100 x 610 mm	100 x 610 mm
Gewicht	2,7 kg	4,8 kg	4,3 kg	2,1 kg	1,6 kg	4,5 kg	4,8 kg	5,7 kg
Prijs in €	excl. btw							
	incl. btw							

EXCENTRISCHE SCHUURMACHINES



BO5031K



BO5041K



BO6050J

	BO5031K	BO5041K	BO6030JX	BO6050J
Nominaal vermogen	300 W	300 W	310 W	750 W
Aantal schuurbewegingen	8000-24000/min	8000-24000/min	8000-20000/min	3200-13600/min
Schuuruitslag	2,8 mm	2,8 mm	3 mm	5,5 mm
Ø Schuurvoet	123 mm	123 mm	147 mm	147 mm
Gewicht	1,3 kg	1,4 kg	2,4 kg	2,6 kg
Prijs in €	excl. btw			
	incl. btw			

HAAKSE SCHUURMACHINE



SA7000C

SA7000C	
Nominaal vermogen	1600 W
Toerental onbelast	0-4000 t.p.m
Ø schijf	180 mm
Gewicht	3,4 kg
Prijs in €	excl. btw
	incl. btw

EXCENTRISCHE POLIJSTMACHINE



PO6000C

PO6000C	
Nominaal vermogen	890 W
Aantal schuurbewegingen	0-13600/min.
Ø schijf	150 mm
Schuuruitslag	5,5 mm
Gewicht	2,7 kg
Prijs in €	excl. btw
	incl. btw

SCHUUR- EN POETSMACHINE



9237CB

9237CB	
Nominaal vermogen	1200 W
Toerental	0-3200 t.p.m.
Ø schijf	180 mm
Gewicht	3,4 kg
Prijs in €	excl. btw
	incl. btw

BORSTELSCUURMACHINE



9741J

9741J	
Nominaal vermogen	860 W
Toerental	3500 t.p.m.
Gewicht	4,2 kg
Prijs in €	excl. btw
	incl. btw

GASNAGELPISTOOL VOOR
AFWERKNAGELS 16 GA



GF600SE

Accu	7,2 V / 1,0 Ah
Gemiddelde laadtijd	30 min
Doorsnede nagel	1,6 mm
Lengte nagel	15-64 mm
Gewicht	2,2 kg
Prijs in €	excl. btw
	incl. btw

GASNAGELPISTOOL
VOOR BETON



GN420CSE

Accu	7,2 V / 1,0 Ah
Gemiddelde laadtijd	30 min
Doorsnede nagel	2,6-3,0 mm
Lengte nagel	15-40 mm
Gewicht	3,5 kg
Prijs in €	excl. btw
	incl. btw

GASNAGELPISTOOL VOOR HOUT



GN900SE

Accu	7,2 V / 1,0 Ah
Gemiddelde laadtijd	30 min
Doorsnede nagel	2,9-3,3 mm
Lengte nagel	50-90 mm
Gewicht	3,3 kg
Prijs in €	excl. btw
	incl. btw

PNEUMATISCH NIETPISTOOL 18 GA



AT638A

Werkdruk	4,2 - 8 bar
Draadkaliber	18 Ga
Doorsnede niet	1,1x1,3 mm
Rugbreedte niet	5 mm
Lengte niet	15-38 mm
Gewicht	1,5 kg
Prijs in €	excl. btw
	incl. btw

PNEUMATISCH ROLNAGELPISTOOL



AN454

Werkdruk	4,9-8,3 bar
Doorsnede nagel	3,05 mm
Lengte nagel	19-45 mm
Gewicht	2,4 kg
Prijs in €	excl. btw
	incl. btw

PNEUMATISCH CONSTRUCTIE-
NAGELPISTOOL 21°



AN924

Werkdruk	4,9-8,3 bar
Doorsnede nagel	3,76 mm
Lengte nagel	50-90 mm
Gewicht	3,8 kg
Prijs in €	excl. btw
	incl. btw

MINIBRADPISTOOL 18 GA



AF506

Werkdruk	4,8-8,3 bar
Draadkaliber	18 Ga
Ø Nagelkop	2,0 mm
Doorsnede nagel	1,2 mm
Lengte nagel	15-50 mm
Gewicht	1,4 kg
Prijs in €	excl. btw
	incl. btw

BRADPISTOOL 16 GA



AF601

Werkdruk	0,49 - 8,3 bar
Draadkaliber	16 Ga
Doorsnede nagel	1,6 mm
Lengte nagel	25 - 64 mm
Gewicht	1,7 kg
Prijs in €	excl. btw
	incl. btw

PNEUMATISCH
CONSTRUCTIENAGELPISTOOL 34°



AN943K

Werkdruk	4,5-8,5 bar
Ø Nagelkop	7,0 mm
Doorsnede nagel	2,9-3,3 mm
Lengte nagel	50-90 mm
Gewicht	3,9 kg
Prijs in €	excl. btw
	incl. btw

LASERAFSTANDSMETER



LD080PI



LD030P



	LD030P	LD050P	LD080PI
Bereik	30 m	50 m	80 m
Gewicht	0,1 kg	0,1 kg	0,1 kg
Prijs in €	excl. btw		
	incl. btw		

ROTARENDE LASER



PROMO
gratis statief 2,7 m
t.w.v.



Inclusief ontvanger, bril voor laser, afstandsbediening en wandbevestiging

		SKR200Z
Rotatiesnelheid		0-600 t.p.m.
Bereik		100 m
Gewicht		1,6 kg
Prijs in €	excl. btw	
	incl. btw	

ACCU MUURSCANNER



De DWD181 gebruikt radartechnologie om nauwkeurig metaal, hout, elektrische bekabeling en andere objecten in wanden en vloeren te detecteren

4,1 inch kleurenscherm

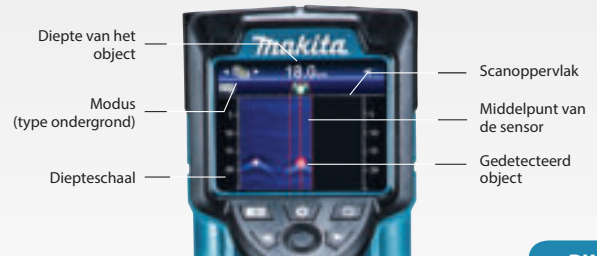

		DWD181ZJ
Spanning		14,4V/18V
Max. detectiediepte		25 - 180 mm
Tolerantie detectiediepte		± 5 mm
Minimum detecteerbare afstand tussen objecten		40 mm
Bijgeleverde lader/accu		-
Gewicht zonder accu		1,0 kg
Prijs in €	excl. btw	
	incl. btw	

KRUISLIJN- EN LIJNLASERS (CXT)

SK105DZ, SK105GDZ,
SK106DZ & SK106GDZ
PROMO
Incl. BL1021B + DC105B



SK105DZ

SK106GDZ

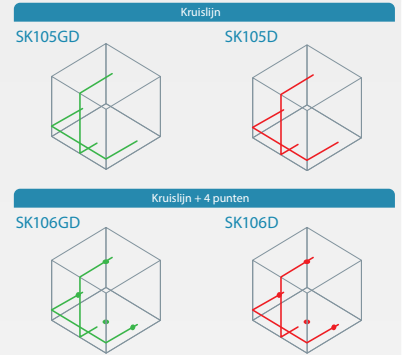

	SK105DZ	SK105GDZ	SK106DZ	SK106GDZ
Kleur	Rood	Groen	Rood	Groen
Projecties	1 H - 1 V	1 H - 1 V	1 H - 1 V + 4 punten	1 H - 1 V + 4 punten
Nauwkeurigheid	+3 mm / 10 m	+3 mm / 10 m	+3 mm / 10 m	+3 mm / 10 m
Bereik	25 m	25 m	25 m	25 m
Bijgeleverde accu's	1 x BL1021B + DC105B	1 x BL1021B + DC105B	1 x BL1021B + DC105B	1 x BL1021B + DC105B
Gewicht	0,67 kg	0,67 kg	0,69 kg	0,69 kg
Prijs in €	excl. btw			
	incl. btw			

SK10GD/SK20GD/SK40GD

- Groene laser met hoge helderheid
- Uiterst nauwkeurig
- Stevige constructie, beschermingsklasse IP54

Horizontaal / 4-Verticale lijnen

Horizontaal / 2-Verticale lijnen

Kruislijn + Punt

SK40GD

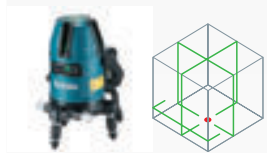

SK20GD

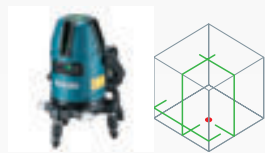

SK10GD

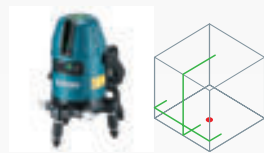

SK10GDZ, SK20GDZ, SK40GDZ
SK209GDZ & SK312GDZ
PROMO
gratis powerpack 197658-5



SK209GDZ



SK312GDZ

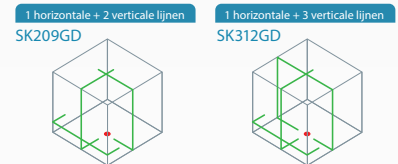

	SK10GDZ	SK20GDZ	SK40GDZ	SK209GDZ	SK312GDZ
Kleur	Groen	Groen	Groen	Groen	Groen
Projecties	1 H - 1 V + loodpunt	1 H - 2 V + loodpunt	1 H - 4 V + loodpunt	1 H - 2 V + loodpunt	1 H - 3 V + loodpunt
Nauwkeurigheid	±1 mm/10m	±1 mm/10m	±1 mm/10m	+1 mm / 10 m	+1 mm / 10 m
Bereik	-	-	-	-	-
Bijgeleverde accu's	2x BL1021B + DC105B	2x BL1021B + DC105B	2x BL1021B + DC105B	2x BL1021B + DC105B	2x BL1021B + DC105B
Gewicht	1,4 - 1,6 kg	1,4 - 1,6 kg	1,4 - 1,6 kg	1,5 - 1,6 kg	1,5 - 1,6 kg
Prijs in €	excl. btw				
	incl. btw				

KRUISLIJN- EN LIJNLASERS (CXT)

SK700DZ/SK700GDZ:

- 3x 360° laser (3 stralen: 1 horizontaal 360° + 2 verticaal 360°).
- Zeer hoge nauwkeurigheid.
- Blokkeerstand voor projectie van schuine lijnen en voor transport.
- Zeer grote autonomie dankzij de 12Vmax CXT batterij.
- IP54 bescherming.

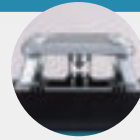

Via een sneldraaiende conische spiegel wordt de laserstraal over 360° geprojecteerd.

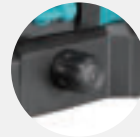

Fijnafstelling: Via een knop op de basis kan de unit zeer precies over een bereik van 10° gedraaid worden. De bevestiging is excentrisch zodat de kruising van de lijnen bij het draaien op hetzelfde punt blijft.

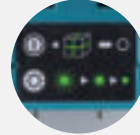

Helderheidsinstelling
Via de 3 helderheidsinstellingen (100% – 75% – 50%) kan de intensiteit van de laser perfect aangepast worden aan de omstandigheden.

Hoge intensiteit

De SK700GDZ met krachtige groene laser biedt een uitstekende zichtbaarheid, ook in een omgeving met invallend daglicht.



SK700DZ



SK700GDZ



SK700DZ & SK700GDZ
INCLUSIEF:
Powerpack 197658-5



OPTIONEEL CP00000001
ADP09 Batterij adapter voor SK700
Werkt met 8 x 1,5V AA-batterijen
excl btw:
incl btw:



	SK700DZ	SK700GDZ
Kleur	Rood	Groen
Projecties	3 x 360° rood	3 x 360° groen
Nauwkeurigheid	±2mm/10m	±2mm/10m
Bereik	25 m	35 m
Bijgeleverde accu's	2x BL1021B + DC105B	2x BL1021B + DC105B
Gewicht	0,99 – 1,2 kg	0,99 – 1,2 kg
Prijs in €	excl. btw	
	incl. btw	

Accessories

TK0LM2000F

Statief 400 - 1140 mm
excl btw:
incl btw:



TK0LM4001F

Statief 680 - 1800 mm
excl btw:
incl btw:



TK0LM5030F

Statief 780 - 2900 mm
excl btw:
incl btw:



LE00870137

Muur- en plafondbevestiging SK105, SK106, SK700
excl btw:
incl btw:



TK00ET03F1

Muur- en plafondbevestiging SK10, SK20, SK40, SK209, SK312
excl btw:
incl btw:



LE00855702

Laserlijntonvanger (80 m) SK105, SK106, SK700
excl btw:
incl btw:



TK0LDG501G

Laserlijntonvanger SK10,SK20, SK40
excl btw:
incl btw:



TK0LDG301G

Laserlijntonvanger SK209, SK312
excl btw:
incl btw:



DECADP05

Adapter voor LXT batterijen
excl btw:
incl btw:



199178-5

USB voedingskabel voor ADP05 (SK105 / SK106)
excl btw:
incl btw:



199010-3

USB voedingskabel voor ADP05 (SK209 / SK312)
excl btw:
incl btw:



DLX4181PT2

ACCU COMBOPACK TUIN

36V

18V LITHIUM-ION



DLX4181PT2

Bijgeleverde accu's	2 x accu 5,0 Ah
Duo snellader	DC18RD
Heggenschaar	DUH507
Bladblazer	DUB184
Grastrimmer	DUR193
Grasmaaier	DLM432
Prijs in €	excl. btw
	incl. btw

DLX5057PTJ

ACCU COMBOPACK TUIN

36V

XPT

BL MOTOR

18V LITHIUM-ION



DLX5057PTJ

Bijgeleverde accu's	4 x accu 5,0 Ah
Duo snellader	DC18RD
Heggenschaar	DUH601
Kettingzaag	DUC353
Grastrimmer	DUR368
Grasmaaier	DLM463
Bladblazer	DUB362
Prijs in €	excl. btw
	incl. btw



DUC353Z DUC405Z

DUR368LZ

DUR190UT11

DUR369AZ

DUR368AZ

DUC405Z

DLM481CT2

DUR368AZ

DLM539CT2

DLM536Z

DLM537Z

DLM463Z

DLM463PT2

DLM465Z

DLM465PT2

DLM539CT2

UM600DSAEX

DUM604RFEX

DUM111SYX

DUM604ZX



LM003GM102

LM004GM102



PROMO BL1850B
1 accu 5,0 Ah gratis na online registratie
Bij aankoop van een LXT machine



Z-versies
geleverd zonder
batterijen of lader

Promo: gratis artikelen direct geleverd bij de machines 1 accu 4,0 Ah na online registratie



GRATIS
Gereedschapset



DUC256Z001

DUC256Z001

DUC356Z001

DUC406Z001

DUC306Z001



GRATIS
Opbergtas

Bij aankoop van een 40Vmax machine hieronder

Gratis promo na online registratie



GRATIS
Blaas- en zuigmachine

UC003GM101 UC004GM101

UC002GM101 UC010GT101

UC011GT101

UC012GT102

UC013GT102



UC003GM101



UB001GM101

UB001GM101

UH007GM201

UH014GM101



DG001GM105

DG001GM105

UH004GM201

UH006GM201

UH013GM101

UH007GM201

UH005GM201



GRATIS
Lantaarn met
radio en
Bluetooth



DUH501RTE

DUH501RTE

Deze XGT machines
zijn geleverd met
batterij(en) en lader



Ontvang een gratis cadeau!

Van 01 januari 2024 t.e.m. 31 maart 2024 kan u bij aankoop van de bovenstaande producten een gratis cadeau aanvragen! Voor de gratis producten na online registratie: surf naar www.makita.be en vul het formulier in dat u kan terug vinden in 'Mijn Makita'. Na ontvangst van de correcte gegevens sturen we het gratis product zo snel mogelijk naar u toe.

De actie is uitsluitend van toepassing op aankopen bij een officieel erkende Makitaverdeler. Deze kan u terugvinden in de dealerlocator op www.makita.be. De complete voorwaarden van deze actie zijn na te lezen op de actiepagina in 'Mijn Makita'. Actie niet cumuleerbaar met andere acties en niet van toepassing op machines die deel uitmaken van een combokit of een omruiling in het kader van een reparatie.

DUP362

ACCU SNOEISCHAAR 2 x 18 V



Inclusief
harnas & holster

		DUP362Z	DUP362PT2
Bijgeleverde accu's		-	2 x accu 5,0 Ah
Bijgeleverde lader		-	DC18RD
Max. takdikte		33 mm	33 mm
Gewicht		3,3 kg	3,3 kg
Prijs in €	excl. btw		
	incl. btw		

UP100D

SNOEISCHAAR 12VMAX



		UP100DSMJ
Spanning		10,8 V
Bijgeleverde accu's		1x BL1041B
Bijgeleverde lader		DC10SB
Maximaal afgegeven vermogen		170 W
Snijcapaciteit		25 mm
Afmetingen (L x B x H)		259 x 53 x 98 mm
Gewicht		0,89 - 1,1 kg
Prijs in €	excl. btw	
	incl. btw	



UD2500

ELEKTRISCHE HAKSELAAR



		UD2500
Nominaal vermogen		2500 W
Max. toerental onbelast		40 t.p.m
Max. takdikte		45 mm
Geluidsdruk		84 dB(A)
Gewicht		29,7 kg
Prijs in €	excl. btw	
	incl. btw	



DCU180Z

ACCU KRUIWAGEN 18 V



Elektronische snelheidsregeling



Demonteerbare achterwielen



Geïntegreerde ledverlichting



PROMO

GRATIS BUIZENFRAME
(199009-8)

18V
LITHIUM-ION

XPT
EXTREME PROTECTIVE TECHNOLOGY

BL
MOTOR

LXT



Optionele accessoires

199008-0

Kipbak
(excl. btw) / (incl. btw)



DCU180Z

Rijsnelheid	0 - 3,5 km/u	
Draagvermogen	130 kg	
Max. helling	12 °	
Prijs in €	excl. btw	
	incl. btw	

DCU603 / DCU604 / DCU605

ACCU KRUIWAGEN 2 X 18 V

36V

WG
NET GUARD

BL
MOTOR

LXT

- Roestvrije kunststof kuip.
- De binnenzijde en de voorkant zijn onder een hoek geplaatst om het uitkiepen te vergemakkelijken.



DCU603

Met kuip en manuele kiepfunctie

- Ideaal voor het transporteren van materiaal in dozen, kisten of zakken.
- Met een verstelbaar buizenframe.
Lengte: 945 mm-1090 mm
Breedte: 625 mm-1015 mm



DCU604

Met frame en manuele kiepfunctie

- Roestvrije kunststof kuip
- De kuip heeft een volledig vlakke bodem en afsluitbare afvoeropening onderaan.
- Ideaal voor het transport van vloeistoffen of korrelig materiaal.



DCU605

Met vaste, vlakke kuip

	DCU603Z	DCU604Z	DCU605Z
Spanning	2 x 18V	2 x 18V	2 x 18V
Type	Kantelbare kuip	Kantelbaar frame	Vaste kuip
Volume kuip	100 l	-	250 l
Max. lading vlak terrein	300 kg	300 kg	300 kg
Max. lading helling (3° - 12°)	180 kg	180 kg	180 kg
Rijsnelheid voorruit	1,5 - 3,5 - 5,0 km/h	1,5 - 3,5 - 5,0 km/h	1,5 - 3,5 - 5,0 km/h
Rijsnelheid achterruit	1,0 km/h	1,0 km/h	1,0 km/h
Gewicht	122 - 124 kg	122 - 124 kg	122 - 124 kg
Prijs in €	excl. btw		
	incl. btw		

PF0800 / PF1100

DOMPELPOMPEN VOOR ZUIVER WATER



PF0800

PF1010

PF1100

PF1110

PF1010 / PF1110

DOMPELPOMPEN VOOR VUIL WATER

	PF0800	PF1010	PF1100	PF1110
Nominaal vermogen	800 W	1100 W	1100 W	1100 W
Max. debiet	220 l/min	240 l/min	250 l/min	250 l/min
Max. opvoerhoogte	9 m	10 m	9 m	10 m
Gewicht	6,1 kg	6,6 kg	6,7 kg	7,0 kg
Prijs in €	excl. btw			
	incl. btw			

DUS108Z / DUS158Z

ACCU RUGSPROEIERS



DUS108Z

DUS158Z

	DUS108Z	DUS158Z
Spanning	18V	18V
Bijgeleverde accu's	-	-
Tankinhoud	10 l	15 l
Debiet	0,8 - 1,3 l/min	0,8 - 1,3 l/min
Max. druk	3,0 bar	3,0 bar
Afmetingen	325 x 237 x 439 mm	325 x 237 x 517 mm
Gewicht	4,6 kg	4,6 kg
Prijs in €	excl. btw	
	incl. btw	



PM001GZ01

ACCU RUGGEDRAGEN VERNEVELAAR



	PM001GZ01
Spanning	36V (40Vmax)
Tankinhoud	15,0 l
Luchtdebiet	9,0 - 11,0 - 13,3 m ³ /min
Blaaskracht	6,0 - 9,5 - 15 N
Verstuifcapaciteit	500 - 1400 ml/min
Geluidsdruk	87 dB(A)
Gewicht	13,2 - 15,7 kg
Prijs in €	excl. btw
	incl. btw

US053DZ / DUS054Z

ACCU COMPACTE SPROEIER

UITSCHUIFBARE SPUITLANS: 0,5 - 0,7 M



DUS054Z

	US053DZ	DUS054Z
Spanning	10,8V (12Vmax)	18V
Bijgeleverde accu's	-	-
Tankinhoud	5 l	5 l
Debiet	0,2 l/min	0,2 l/min
Max. druk	2,6 bar	2,6 bar
Afmetingen	340 x 183 x 360 mm	340 x 183 x 360 mm
Gewicht	2,9 - 3,0 kg	3,2 - 3,5 kg
Prijs in €	excl. btw	
	incl. btw	

HW001GZ

ACCU HOGEDRUKREINIGER
40VMAX



HW001G

- Hoge reinigingskracht met goede balans tussen druk en debiet
- Voeding middels één of twee 40Vmax accu's
- 3 vermogensstanden
- Telescopisch handvat en compartiment voor de accessoires
- Autonomie bij max. vermogen: 18 min (2x BL4050F)

NIEUW

HW001GZ

Spanning	36V (40Vmax)
Bijgeleverde accu's	-
Lader	-
Werkdruk	30/55/85 bar
Debiet	3,0/4,2/5,5 l/min
Lengte hogedrukslang	6 m
Gewicht	10,1 - 13,2 kg
Prijs in €	excl. btw
	incl. btw

DHW080ZK

ACCU HOGEDRUKREINIGER



Capaciteit
watertank

50 l

Werkdruk

30/55 bar

Debiet

4,0/5,5 l/min

Compatibel

Er is een breed assortiment aan hulpstukken beschikbaar, ze zijn ook compatibel met de HW1200 / HW1300.



DHW080ZK

Spanning	2 x 18V
Bijgeleverde accu's	-
Lader	-
Werkdruk	30/55 bar
Debiet	4,0/5,5 l/min
Inhoud watertank	50 l
Gewicht	7,1-7,7 kg
Prijs in €	excl. btw
	incl. btw

HW1200 / HW1300 / HW131 / HW151

ELEKTRISCHE HOGEDRUKREINIGERS



HW1300



HW151



HW131

	HW1200	HW1300	HW131	HW151
Vermogen	1800 W	1800 W	2200 W	2500 W
Max. druk	120 bar	130 bar	130 bar	150 bar
Max. debiet	420 l/u	420 l/u	500 l/u	500 l/u
Haspel	10 m	10 m	15 m	10 m
Gewicht	11,0 kg	12,7 kg	33 kg	26,9 kg
Prijs in €	excl. btw			
	incl. btw			

DDG460 / DDG461

ACCU GRONDBOOR 2 x 18 V

LXT

ADT

BL MOTOR

XPT

18V + 18V

36V



DDG460Zx7

Met mechanische slipkoppeling en omkeerschakelaar

NIEUW

	DDG460Zx7	DDG460T2x7	DDG461Z
Spanning	2 x 18 V	2 x 18 V	2 x 18 V
Max. boorcapaciteit	200 mm	200 mm	200 mm
Aansluiting	Boorkop en adapter	Boorkop en adapter	Directe as-gat verbinding
Max. koppel	136 Nm	136 Nm	136 Nm
Toerental onbelast	0 - 350 min ⁻¹ 0 - 1400 min ⁻¹	0 - 350 min ⁻¹ 0 - 1400 min ⁻¹	0 - 350 min ⁻¹ 0 - 1400 min ⁻¹
Bijgeleverde accu's	-	2x BL1850B	-
Bijgeleverde lader	-	DC18RD	-
Gewicht	7,3 - 8,2 kg	7,3 - 8,2 kg	7,0 - 7,6 kg
Prijs in €	excl. btw		
	incl. btw		

DG001G / DG002G

ACCU GRONDBOOR 40VMAX

WG WET GUARD

ADT

BL MOTOR

XPT

XGT 40Vmax

NIEUW

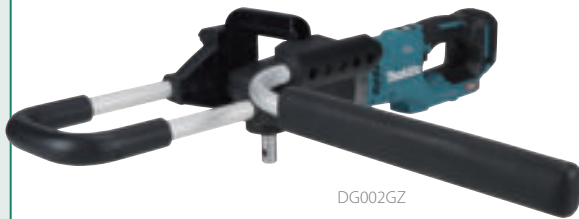

DG002GZ

Met mechanische slipkoppeling en omkeerschakelaar

PROMO

gratis AS001GZ na online registratie DG001GM105



	DG001GZ05	DG001GM105	DG002GZ
Spanning	36V (40Vmax)	36V (40Vmax)	36 V (40Vmax)
Max. boorcapaciteit	200 mm	200 mm	200 mm
Aansluiting	Boorkop en adapter	Boorkop en adapter	Directe as-gat verbinding
Max. koppel	136 Nm	136 Nm	136 Nm
Toerental onbelast	0 - 400 min ⁻¹ 0 - 1 500 min ⁻¹	0 - 400 min ⁻¹ 0 - 1 500 min ⁻¹	0 - 400 min ⁻¹ 0 - 1 500 min ⁻¹
Bijgeleverde accu's	-	1 x BL4040	-
Bijgeleverde lader	-	DC40RA	-
Gewicht	7,2 - 8,1 kg	7,2 - 8,1 kg	6,8 - 8,0 kg
Prijs in €	excl. btw		
	incl. btw		

Adapters



327687-6
Adapter Type D
voor Makita grondboren



327684-2
Adapter Type A
voor Stihl grondboren

Grondboren met hexagonale schacht



Artikel nr.	Diameter	Totale lengte	Nuttige lente	Prijs (excl. btw)	Prijs (incl. btw)
D-75415	Ø 30 mm	600 mm	200 mm		
D-75421	Ø 45 mm	600 mm	200 mm		
D-75437	Ø 70 mm	600 mm	200 mm		
D-75443	Ø 100 mm	600 mm	200 mm		
D-75459	Ø 130 mm	600 mm	200 mm		
E-17049	Ø 40 mm	600 mm	470 mm		

E-17049 met dubbele schroef en langere werklengte!

Grondboren te gebruiken met adapter (type D) incl. borgpen

Artikel nr.	Diameter	Totale lengte	Nuttige lengte	Prijs (excl. btw)	Prijs (incl. btw)
E-13611	Ø 50 mm	800 mm	550 mm		
E-13627	Ø 60 mm	800 mm	550 mm		
E-13633	Ø 80 mm	800 mm	550 mm		
E-07294	Ø 100 mm	800 mm	550 mm		
E-07303	Ø 150 mm	800 mm	550 mm		
E-07319	Ø 200 mm	800 mm	550 mm		

E-07325
Verlengstuk
540 mm



Vervangmesjes	Prijs (excl. btw)	Prijs (incl. btw)
E-13649		
E-13655		
E-13661		
E-07630		
E-07646		
E-07652		

E-07331
Borgpen





DUX18

ACCU COMBISYSTEEM 18 V



DUX18Z

		DUX18Z	DUX18ZX1
Platform		LXT 18 V	LXT 18 V
Max. afgegeven vermogen		470 W	470 W
Toerental onbelast		0 - 6800 / 0 - 9700 min ⁻¹	0 - 6800 / 0 - 9700 min ⁻¹
Bijgeleverde accessoires		-	EM408MP
Bijgeleverde accu's / laders		-	-
Prijs in €	excl. btw		
	incl. btw		

DUX60

ACCU COMBISYSTEEM
2 x 18 V



DUX60Z

	DUX60Z	DUX60ZN1	DUX60ZM4	DUX60ZX8
Platform	LXT 2 x 18 V	LXT 2 x 18 V	LXT 2 x 18 V	LXT 2 x 18 V
Max. afgegeven vermogen	600 W	600 W	600 W	600 W
Toerental onbelast	0 - 5700 / 0 - 8200 / 0 - 9700 min ⁻¹	0 - 5700 / 0 - 8200 / 0 - 9700 min ⁻¹	0 - 5700 / 0 - 8200 / 0 - 9700 min ⁻¹	0 - 5700 / 0 - 8200 / 0 - 9700 min ⁻¹
Bijgeleverde accessoires	-	EN401MP	EM404MP	EN401MP EM404MP
Bijgeleverde accu's / laders	-	-	-	-
Prijs in €	excl. btw			
	incl. btw			

COMBISYSTEEM OPZETSTUKKEN

Artikel	Referentie	Ø (mm)	Prijs excl. btw	Prijs incl. btw
BOSMAAIER (Voor DUX18 enkel EM408MP geschikt)				
EM404MP	198768-1	450 mm		
EM401MP	195888-2	300 mm		
EM400MP	195648-2	420 mm		
EM406MP	198779-6	420 mm		
EM408MP	191N31-5	300 mm		
ROTORSCHAAR				
EM407MP	191M56-3			
GRASTRIMMER				
ER400MP	195522-4	410 mm		
SNOEIKETTINGZAAG				
EY403MP	191T38-7			
STOKHEGGENSCHAAR				
EN401MP	196256-2			
EN410MP	197726-4			
GRONDFREES				
KR400MP	199181-6			
BOORDENSNIJDER				
EE400MP	196752-0			
VERLENGSTUK				
LE400MP	191E24-8			
ROLVEGER				
SW400MP	199339-7			
ROLBORSTEL				
BR400MP	199318-5			
BLAZER				
UB401MP	191P72-3			
UB402MP	1912R8-4			
WATERPOMP				
PF400MP	DEAPF400MP			
MAAIBALK				
NIEUW	EN424MP	1913C9-3		

UX01GZ

ACCU COMBISYSTEEM 40VMAX



	UX01GZ	UX01GZ01
Platform	XGT 40Vmax	XGT 40Vmax
Max. afgegeven vermogen	1000 W	1000 W
Toerental onbelast	0 - 5700 / 0 - 8200 / 0 - 9700 min ⁻¹	0 - 5700 / 0 - 8200 / 0 - 9700 min ⁻¹
Bijgeleverde accessoires	-	EM404MP
Bijgeleverde accu's / laders	-	-
Prijs in €	excl. btw	
	incl. btw	



DUR193

ACCU GRASTRIMMER 18V



DUR193RF

	DUR193Z	DUR193RF
Spanning	18V	18V
Bijgeleverde accu's	-	1 x accu 3,0 Ah
Bijgeleverde lader	-	DC18RC
Snelheden	1	1
BL motor	-	-
ADT	-	-
AFT	-	-
Handgreep	Rond ("D")	Rond ("D")
Schacht	Telescopisch	Telescopisch
Max. uitgangsvermogen	280 W	280 W
Gewicht	2,3 - 2,6 kg	2,3 - 2,6 kg
Prijs in €	excl. btw	
	incl. btw	

DUR189

ACCU GRASTRIMMER 18V

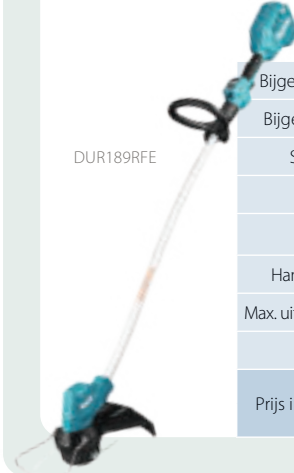

DUR189RFE

	DUR189Z	DUR189RFE
Bijgeleverde accu's	-	2x accu 3,0 Ah
Bijgeleverde lader	-	DC18RC
Snelheden	3	3
ADT	✓	✓
AFT	-	-
Handgreepvorm	D	D
Max. uitgangsvermogen	240 W	240 W
Gewicht	3,0 - 3,3 kg	3,0 - 3,3 kg
Prijs in €	excl. btw	
	incl. btw	

DUR194

ACCU GRASTRIMMER 18V



- COMPATIBEL MET DRAADKOP, KOP MET NYLON MESSEN EN METALEN 8-TANDS MAAIBLAD
- MET UNIVERSELE BESCHERMKAP



DUR194SFX2

	DUR194ZX3	DUR194SFX2	DUR194RTX1
Spanning	18V	18V	18V
Bijgeleverde accu's	-	1x accu 3,0 Ah	1x accu 5,0 Ah
Bijgeleverde lader	-	DC18SD	DC18RC
Snelheden	2	2	2
BL motor	-	-	-
ADT	-	-	-
AFT	-	-	-
Handgreep	D	D	D
Max. uitgangsvermogen	230 W	230 W	230 W
Gewicht	2,6 - 2,9 kg	2,6 - 2,9 kg	2,6 - 2,9 kg
Prijs in €	excl. btw		
	incl. btw		

DUR190 / DUR191

ACCU GRASTRIMMERS 18V

SCHACHT IN EEN DEEL (DUR190)

DEMONTTEERBARE SCHACHT VOOR TRANSPORT (DUR191)



DUR190UT11

DUR191LZX9

PROMO

Gratis BL1850B bij DUR190UT11 na online registratie



	DUR190UZ9	DUR190UT11	DUR191LZX3	DUR191LZX9
Spanning	18V	18V	18V	18V
Bijgeleverde accu's	-	1 x accu 5,0 Ah	-	-
Lader	-	DC18SD	-	-
Snelheden	3	3	3	3
ADT	-	✓	✓	✓
AFT	-	✓	✓	✓
Handgreepvorm	U	U	D	D
Max. uitgangsvermogen	240 W	240 W	240 W	240 W
Gewicht	3,4 kg	3,1 kg	3,1 kg	3,1 kg
Prijs in €	excl. btw			
	incl. btw			

- DUR190UT11 INCLUSIEF MAAIMES
- EASY FILL MAAIKOP OP DUR190UZ9, DUR190UT11 EN DUR191LZX9

UR016G / UR017G

ACCU BOSMAAIERS 40VMAX



UR016GZ

	UR016GZ	UR017GZ
Spanning	36V (40Vmax)	36V (40Vmax)
Bijgeleverde accu's	-	-
Bijgeleverde lader	-	-
Toerental onbelast	3500/5300/ 6500 min ⁻¹	3500/5300/ 6500 min ⁻¹
Handgreepvorm	Dubbel ("U")	Rond ("D")
ADT	✓	✓
AFT	✓	✓
Max. uitgangsvermogen	600 W	600 W
Gewicht	4,6 - 5,4 kg	4,2 - 4,8 kg
Prijs in €	excl. btw	
	incl. btw	

UR002G / UR006G / UR007G

ACCU BOSMAAIERS 40VMAX

PROMO

Gratis AS001GZ na online registratie UR006GM101



UR002GZ01

UR006GM101



	UR002GZ01	UR006GZ02	UR007GZ01
Spanning	36V (40Vmax)	36V (40Vmax)	36V (40Vmax)
Max. toerental onbelast	3500 - 5300 - 6500 min ⁻¹	4600 - 5500 - 7000 min ⁻¹	4600 - 5500 - 7000 min ⁻¹
Snelheden	3 + auto	3 + auto	3 + auto
Handgreepvorm	Dubbel ("U")	Dubbel ("U")	Rond ("D")
ADT	✓	✓	✓
AFT	✓	✓	✓
Bijgeleverde accu's	0	0	0
Bijgeleverde lader	0	0	0
Max. uitgangsvermogen	550 W	1 kW	1 kW
Gewicht	4,6 - 5,3 kg	5,7 - 6,3 kg	5,7 - 6,3 kg
Prijs in €	excl. btw		
	incl. btw		

DUR368 / DUR369

ACCU BOSMAAIERS 2X18V



PROMO

Gratis BL1850B na online registratie



DUR369AZ

DUR368LZ

	DUR368LZ	DUR368AZ	DUR369AZ
Spanning	2x 18V	2x 18V	2x 18V
Max. toerental onbelast	6500 t.p.m.	6500 t.p.m.	7000 t.p.m.
Bijgeleverde accu's	-	-	-
Bijgeleverde lader	-	-	-
Snelheden	3	3	3
ADT	✓	✓	✓
AFT	✓	✓	✓
Handgreep	Rond ("D")	Dubbel ("U")	Dubbel ("U")
Max. uitgangsvermogen	550 W	550 W	1000 W
Gewicht	3,9 - 4,5 kg	4,1 - 4,7 kg	5,9 - 6,5 kg
Prijs in €	excl. btw		
	incl. btw		



UR013G / UR014G

ACCU BOSMAAIERS 40VMAX

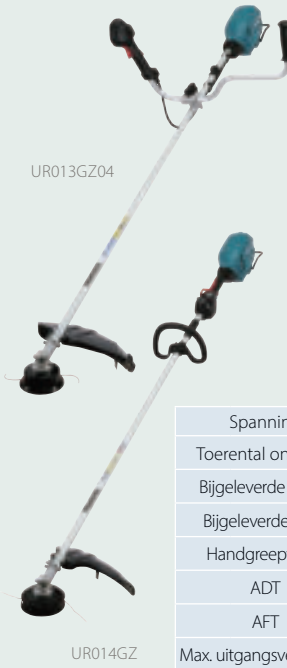

UR013G/UR014G

Extra hoog koppel in "High torque mode", bijzonder geschikt voor zware toepassingen

UR014G

- enkel te gebruiken met draadkop
- de draairichting is omkeerbaar

		UR013GZ04	UR014GZ
Spanning		36V (40Vmax)	36V (40Vmax)
Toerental onbelast		3500 - 6700 min ⁻¹	4000 - 5000 min ⁻¹
Bijgeleverde accu's		-	-
Bijgeleverde lader		-	-
Handgreepvorm		Dubbel ("U")	Rond ("D")
ADT		-	-
AFT		✓	✓
Max. uitgangsvermogen		1500 W	1500 W
Gewicht		5,9 - 7,2 kg	5,5 - 6,7 kg
Prijs in €	excl. btw		
	incl. btw		

Optionele accessoires



Hakselmes 270 mm
199874-5
(excl. btw)
(incl. btw)

Beschermkap voor hakselmes
199875-3
(excl. btw)
(incl. btw)



Zaagblad met beiteltanden 225 mm
199872-9
(excl. btw)
(incl. btw)

Beschermkap voor zaagblad
UR012G
199873-7
(excl. btw)
(incl. btw)



Heupharnas
191E43-4
enkel te gebruiken met PDC01 en PDC1200
(excl. btw)
(incl. btw)

UR012G

ACCU BOSMAAIER 2 x 40VMAX



UR012GZ02

Max. uitgangsvermogen
2,0 kW

		UR012GZ02
Spanning		2 x 40Vmax
Max. toeren onbelast		3500 - 5000 - 6800 min ⁻¹
Snelheden		3 + auto
ADT		✓
AFT		✓
Bijgeleverde accu's		-
Bijgeleverde lader		-
Max. uitgangsvermogen		2,0 kW
Gewicht		8,0 - 9,3 kg
Prijs in €	excl. btw	
	incl. btw	

UC100D / DUC101

ACCU SNOEIZAGEN



DUC101SF

	UC100DZ	DUC101Z	DUC101SF
Spanning	10,8V (12Vmax)	18V	18V
Bijgeleverde accu's	-	-	1x accu 3,0 Ah
Bijgeleverde lader	-	-	DC18SD
BL motor	✓	✓	✓
Snelspansysteem	✓	✓	✓
Zwaardlengte	100 mm	100 mm	100 mm
Ketting	80 TXL (0,325, 1,1 mm)	80 TXL (0,325, 1,1 mm)	80 TXL (0,325, 1,1 mm)
Kettingsnelheid	8 m/s	8 m/s	8 m/s
Gewicht	1,5-1,6 kg	1,6-2,0 kg	1,6-2,0 kg
Prijs in €	excl. btw		
	incl. btw		

DUA301

ACCU HOOGSNOEIER 2 x 18 V



DUA301Z

	DUA301Z	DUA301PT2
Spanning	2x 18V	2x 18V
Bijgeleverde accu's	0	2x 5,0 Ah
Bijgeleverde lader	-	DC18RD
BL motor	✓	✓
Totale lengte	2,53 - 3,76 m	2,53 - 3,76 m
Bevestiging zwaard	Geïntegreerde moer	Geïntegreerde moer
Zwaardlengte	30 cm	30 cm
Ketting	90PX (0,325", 1,1 mm)	90PX (0,325", 1,1 mm)
Kettingsnelheid	0 - 20 m/s	0 - 20 m/s
Gewicht	7,8 - 8,5 kg	7,8 - 8,5 kg
Prijs in €	excl. btw	
	incl. btw	

UA004G

ACCU HOOGSNOEIER 40VMAX



UA004GZ

	UA004GZ	UA004GM101
Spanning	36V (40Vmax)	36V (40Vmax)
Bijgeleverde accu's	-	1x 4,0 Ah
Bijgeleverde Lader	-	DC40RA
BL motor	✓	✓
Totale lengte	2,53 - 3,76 m	2,53 - 3,76 m
Bevestiging zwaard	Geïntegreerde moer	Geïntegreerde moer
Zwaardlengte	30 cm	30 cm
Ketting	90PX (0,325", 1,1 mm)	90PX (0,325", 1,1 mm)
Kettingsnelheid	0 - 20 m/s	0 - 20 m/s
Gewicht	7,8 - 9,1 kg	7,8 - 9,1 kg
Prijs in €	excl. btw	
	incl. btw	

DUC122 / DUC254

ACCUSNOEIKETTINGZAGEN 18V



OPGELET: voor het gebruik van een tophandle kettingzaag is een opleiding vereist. Raadpleeg steeds de veiligheidsvoorschriften.

	DUC122ZK	DUC122RTE	DUC254Z001
Spanning	18V	18V	18V
Bijgeleverde accu's	-	1 x accu 5,0 Ah	-
Bijgeleverde lader	-	DC18RC	-
BL motor	-	-	✓
Spansysteem	Snelspansysteem	Snelspansysteem	Geïntegreerde moeren
Zwaardlengte	11,5 cm	11,5 cm	25 cm
Ketting	025 (1/4", 1,3 mm)	025 (1/4", 1,3 mm)	80PX (0,325", 1,1 mm)
Kettingsnelheid	5 m/s	5 m/s	24 m/s
Gewicht	2,6 kg	2,6 kg	2,8 - 3,2 kg
Prijs in €	excl. btw		
	incl. btw		

DUC256 / -306 / -356 / -406

ACCUSNOEIKETTINGZAGEN 2 x 18V

PROMO

gratis 87-delige gereedschapset E-08458



DUC256
DUC306
DUC356
DUC406



	DUC256Z001	DUC306Z001	DUC356Z001	DUC406Z001
Spanning	2x 18V	2x 18V	2x 18V	2x 18V
Bijgeleverde accu's	-	-	-	-
Bijgeleverde lader	-	-	-	-
BL motor	✓	✓	✓	✓
Snelspansysteem	-	-	-	-
Geïntegreerde moeren	✓	✓	✓	✓
Zwaardlengte	25 cm	30 cm	35 cm	40 cm
Ketting	80 TXL (0,325, 1,1 mm)	80 TXL (0,325, 1,1 mm)	80 TXL (0,325, 1,1 mm)	80 TXL (0,325, 1,1 mm)
Kettingsnelheid	20 m/s	20 m/s	20 m/s	20 m/s
Gewicht	4,6-5,1 kg	4,6-5,1 kg	4,6-5,1 kg	4,6-5,1 kg
Prijs in €	excl. btw			
	incl. btw			

UC002G / UC003G / UC004G / UC006G

ACCUSNOEIKETTINGZAGEN 40VMAX

PROMO

Gratis AS001GZ na online registratie UC002GM101, UC003GM101, UC004GM101



	UC002GZ	UC002GM101	UC003GZ	UC003GM101	UC004GZ	UC004GM101	UC006GZ
Spanning	36V (40Vmax)	36V (40Vmax)	36V (40Vmax)	36V (40Vmax)	36V (40Vmax)	36V (40Vmax)	36V (40Vmax)
Bijgeleverde accu's	-	1x 4,0 Ah	-	1x 4,0 Ah	-	1x 4,0 Ah	-
Bijgeleverde lader	-	DC40RA	-	DC40RA	-	DC40RA	-
BL motor	✓	✓	✓	✓	✓	✓	✓
Geïntegreerde moeren	✓	✓	✓	✓	✓	✓	✓
Zwaardlengte	25 cm	25 cm	30 cm	30 cm	35 cm	35 cm	25 cm Carving
Ketting	90PX (3/8" 1,1 mm)	90PX (3/8" 1,1 mm)	90PX (3/8" 1,1 mm)	90PX (3/8" 1,1 mm)	90PX (3/8" 1,1 mm)	90PX (3/8" 1,1 mm)	90PX (1/4", 1,3 mm)
Kettingsnelheid	0 - 24,8 m/s	0 - 24,8 m/s	0 - 24,8 m/s	0 - 24,8 m/s	0 - 24,8 m/s	0 - 24,8 m/s	0 - 24,8 m/s
Gewicht	3,8 - 4,7 kg	3,8 - 4,7 kg	3,8 - 4,7 kg	3,8 - 4,7 kg	3,8 - 4,7 kg	3,8 - 4,7 kg	3,8 - 4,7 kg
Prijs in €	excl. btw						
	incl. btw						

DUC307 / DUC357
 ACCU KETTINGZAGEN 18V



18V
LITHIUM-ION
BL
MOTOR
XPT
EXTRA PITCH TECHNOLOGY

DUC357RTX2

PROMO

GRATIS ACCU 5,0 Ah
 na online registratie

DUC353 / DUC405
 ACCU KETTINGZAGEN 2 x 18V



BL
MOTOR
XPT
EXTRA PITCH TECHNOLOGY

DUC405Z

	DUC307ZX2	DUC307RTX2	DUC357ZX2	DUC357RTX2
Spanning	18V	18V	18V	18V
Bijgeleverde accu's	-	1x 5,0 Ah	-	1x 5,0 Ah
Bijgeleverde lader	-	DC18RC	-	DC18RC
BL motor	✓	✓	✓	✓
Snelspansysteem	✓	✓	✓	✓
Zwaardlengte	30 cm	30 cm	35 cm	35 cm
Ketting	90PX (3/8", 1,1 mm)	90PX (3/8", 1,1 mm)	90PX (3/8", 1,1 mm)	90PX (3/8", 1,1 mm)
Kettingsnelheid	7,7 m/s	7,7 m/s	7,7 m/s	7,7 m/s
Gewicht	4,2 - 4,4 kg	4,2 - 4,4 kg	4,2 - 4,4 kg	4,2 - 4,4 kg
Prijs in €	excl. btw			
	incl. btw			

	DUC353Z	DUC405Z
Spanning	2x 18V	2x 18V
Bijgeleverde accu's	-	-
Bijgeleverde lader	-	-
BL motor	✓	✓
Zwaardlengte	35 cm	40 cm
Bevestiging zwaard	Snelspansysteem	Geïntegreerde moeren
Ketting	90PX (3/8", 1,1 mm)	90PX (3/8", 1,1 mm)
Kettingsnelheid	20 m/s	20 m/s
Gewicht	4,6 - 5,5 kg	4,6 - 5,5 kg
Prijs in €	excl. btw	
	incl. btw	

UC010G / UC011G / UC012G / UC013G
 ACCU KETTINGZAAG 40Vmax



UC012GT102

UC013GT102

HOOG VERMOGEN
 HOGE KETTINGSNELHEID
 REGELBAAR OLIEDEBIET
 LAAG TRILLINGSNIVEAU

PROMO

gratis AS001GZ na online registratie UC010GT101, UC011GT101, UC012GT102 & UC013GT102



	UC010GZ	UC010GT101	UC011GZ	UC011GT101	UC012GZ01	UC012GT102	UC013GZ01	UC013GT102
Spanning	36V (40Vmax)	36V (40Vmax)	36V (40Vmax)	36V (40Vmax)	36V (40Vmax)	36V (40Vmax)	36V (40Vmax)	36V (40Vmax)
Bijgeleverde accu's	-	1 x 5,0 Ah	-	1 x 5,0 Ah	-	1 x 5,0 Ah	-	1 x 5,0 Ah
Bijgeleverde lader	-	DC40RA	-	DC40RA	-	DC40RA	-	DC40RA
BL motor	✓	✓	✓	✓	✓	✓	✓	✓
Geïntegreerde moeren	✓	✓	✓	✓	✓	✓	✓	✓
Zwaardlengte	30 cm	30 cm	35 cm	35 cm	40 cm	40 cm	45 cm	45 cm
Ketting	80TXL (0,325, 1,1 mm)	80TXL (0,325, 1,1 mm)	80TXL (0,325, 1,1 mm)	80TXL (0,325, 1,1 mm)	3/8" 1,3 mm	3/8" 1,3 mm	3/8" 1,3 mm	3/8" 1,3 mm
Kettingsnelheid	0 - 25,5 m/s	0 - 25,5 m/s	0 - 25,5 m/s	0 - 25,5 m/s	0 - 25,5 m/s	0 - 25,5 m/s	0 - 25,5 m/s	0 - 25,5 m/s
Gewicht	6,1 - 7,4 kg	6,1 - 7,4 kg	6,1 - 7,4 kg	6,1 - 7,4 kg	6,1 - 7,4 kg	6,1 - 7,4 kg	6,1 - 7,4 kg	6,1 - 7,4 kg
Prijs in €	excl. btw							
	incl. btw							

UM600D / DUM111 / DUM604

ACCU GRAS- EN HEGGENSCHAAR

PROMO

Gratis opbergtas bij UM600DSAEX, DUM111SYX en DUM604RFEX



DUM604RFEX



DUM111SYX

	UM600DSAEX	DUM111SYX	DUM604RFEX	DUM604ZX
Spanning	10,8 V (12Vmax)	18 V	18 V	18 V
Bijgeleverde accu's	2 x accu 2,0 Ah	1 x accu 1,5 Ah	2 x accu 3,0 Ah	-
Lader	DC10SB	DC18SD	DC18RC	-
Snijlengte heggenschaar	20 cm	20 cm	20 cm	20 cm
Snijbreedte grasschaar	16 cm	11 cm	16 cm	16 cm
Maximale takdikte	8 mm			
Geleverd met	Grasschaar + Heggenschaar	Grasschaar + Heggenschaar	Grasschaar + Heggenschaar	Grasschaar + Heggenschaar
Gewicht	1,2 kg	1,8 kg	1,8 kg	1,8 kg
Prijs in €	excl. btw			
	incl. btw			

DUH507 / DUH607 / DUH551

ACCU HEGGENSCHAREN



DUH607Z

DUH551Z



DUH507 & DUH607:

- Budgetvriendelijke versies
- Compact en uiterst licht
- Versterkt krukmechanisme
- Handgreep met nieuw ontworpen schakelaar
- Hoogwaardige trillingsdemping

	DUH507Z	DUH507F001	DUH607Z	DUH607F001	DUH551Z
Spanning	18V	18V	18V	18V	2 x 18V
Bijgeleverde accu's	-	1x accu 3,0 Ah	-	1x accu 3,0 Ah	-
Bijgeleverde lader	-	DC18WC	-	DC18WC	-
BL motor	-	-	-	-	-
Snijlengte	50 cm	50 cm	60 cm	60 cm	55 cm
Maximale takdikte	15 mm	15 mm	15 mm	15 mm	18 mm
Aantal snijbewegingen	2700 min ⁻¹	2700 min ⁻¹	2700 min ⁻¹	2700 min ⁻¹	2000-3600 min ⁻¹
Max. uitgangsvermogen	250 W	250 W	250 W	250 W	320 W
Gewicht	2,7 - 3,0 kg	2,7 - 3,0 kg	2,8 - 3,1 kg	2,8 - 3,1 kg	4,1 kg
Prijs in €	excl. btw				
	incl. btw				

DUH506 / DUH606

ACCU HEGGENSCHAREN 18 V



DUH606RF

DUH506 & DUH606:

- Zeer efficiënt dankzij BL motor
- Compact en uiterst licht
- Versterkt krukmechanisme
- Handgreep met nieuw ontworpen schakelaar
- Hoogwaardige trillingsdemping

	DUH506Z	DUH506RF	DUH606Z	DUH606RF
Spanning	18V	18V	18V	18V
Bijgeleverde accu's	-	1x accu 3,0 Ah	-	1x accu 3,0 Ah
Bijgeleverde lader	-	DC18RC	-	DC18RC
BL motor	✓	✓	✓	✓
Snijlengte	50 cm	50 cm	60 cm	60 cm
Max. takdikte	20 mm	20 mm	20 mm	20 mm
Aantal snijbewegingen	4000 min ⁻¹	4000 min ⁻¹	4000 min ⁻¹	4000 min ⁻¹
Max. uitgangsvermogen	320 W	320 W	320 W	320 W
Gewicht	2,5 - 2,9 kg	2,5 - 2,9 kg	2,7 - 3,0 kg	2,7 - 3,0 kg
Prijs in €	excl. btw			
	incl. btw			

DUH502 / DUH602 / DUH752

ACCU HEGGENSCHAREN 18 V



TANDEN MET KLASSIEKE GEOMETRIE



DUH502RT

		DUH502Z	DUH502RT	DUH602Z	DUH602RT	DUH752Z	DUH752RT
Spanning		18V	18V	18V	18V	18V	18V
Bijgeleverde accu's		-	1 x accu 5,0 Ah	-	1 x accu 5,0 Ah	-	1 x accu 5,0 Ah
Bijgeleverde lader		-	1 x DC18RC	-	1 x DC18RC	-	1 x DC18RC
BL motor		✓	✓	✓	✓	✓	✓
Snijlengte		50 cm	50 cm	60 cm	60 cm	75 cm	75 cm
Max. takdikte		21,5 mm	21,5 mm	21,5 mm	21,5 mm	21,5 mm	21,5 mm
Aantal snijbewegingen		2000 / 3600 / 4400 min ⁻¹	2000 / 3600 / 4400 min ⁻¹	2000 / 3600 / 4400 min ⁻¹	2000 / 3600 / 4400 min ⁻¹	2000 / 3600 / 4400 min ⁻¹	2000 / 3600 / 4400 min ⁻¹
Max. uitgangsvermogen		520 W	520 W	520 W	520 W	520 W	520 W
Gewicht		3,8 kg	3,8 kg	3,8 kg	3,8 kg	3,8 kg	3,8 kg
Prijs in €	excl. btw						
	incl. btw						

DUH501 / DUH601 / DUH751 / DUH754S

ACCU HEGGENSCHAREN 18 V

PROMO

gratis DMR057 na online registratie DUH501RTE



TANDEN MET INNOVATIEVE GEOMETRIE

DUH501RTE



DUH754SZ
(ENKELZIJDIG MES)

INNOVATIEVE GEOMETRIE

Beter snijresultaat
Minder wrijving
Grotere batterijautonomie

		DUH501Z	DUH501RTE	DUH601Z	DUH601PTE	DUH751Z	DUH751PTE	DUH754SZ
Uitvoering		Trim	Trim	Trim	Trim	Trim	Trim	Trim
Mes		Dubbelzijdig	Dubbelzijdig	Dubbelzijdig	Dubbelzijdig	Dubbelzijdig	Dubbelzijdig	Enkelzijdig
Bijgeleverde accu's		-	2 x accu 5,0 Ah	-	2 x accu 5,0 Ah	--	2 x accu 5,0 Ah	-
Bijgeleverde Lader		-	1 x DC18RC	-	1 x DC18RD	-	1 x DC18RD	-
BL motor		✓	✓	✓	✓	✓	✓	✓
Aantal snijbewegingen		2000/3600/4400 min ⁻¹	2000/3600/4400 min ⁻¹	2000/3600/4400 min ⁻¹	2000/3600/4400 min ⁻¹	2000/3600/4400 min ⁻¹	2000/3600/4400 min ⁻¹	2000/3600/4400 min ⁻¹
Snijlengte		50 cm	50 cm	60 cm	60 cm	75 cm	75 cm	75 cm
Max. takdikte		23,5 mm	23,5 mm	23,5 mm	23,5 mm	23,5 mm	23,5 mm	23,5 mm
Max. uitgangsvermogen		520 W	520 W	520 W	520 W	520 W	520 W	520 W
Gewicht		3,8 - 4,5 kg	3,8 - 4,5 kg	3,8 - 4,5 kg	3,8 - 4,5 kg	3,8 - 4,5 kg	3,8 - 4,5 kg	3,4 - 3,9 kg
Prijs in €	excl. btw							
	incl. btw							

UH004G / UH005G

ACCU HEGGENSCHAREN 40VMAX 'TRIMVERSIE'



PROMO

gratis AS001GZ na online registratie UH004GM201 & UH005GM201



UH004GM201

		UH004GZ	UH004GM201	UH005GZ	UH005GM201
Uitvoering		Trim	Trim	Trim	Trim
Mes		Dubbelzijdig	Dubbelzijdig	Dubbelzijdig	Dubbelzijdig
Bijgeleverde accu's		-	2x BL4040	-	2x BL4040
Bijgeleverde lader		-	DC40RA	-	DC40RA
Aantal snijbewegingen		2000/3600/5000 min ⁻¹	2000/3600/5000 min ⁻¹	2000/3600/5000 min ⁻¹	2000/3600/5000 min ⁻¹
Snijlengte		60 cm	60 cm	75 cm	75 cm
Max. takdikte		23,5 mm	23,5 mm	23,5 mm	23,5 mm
Max. uitgangsvermogen		720 W	720 W	720 W	720 W
Gewicht		4,3 - 4,9 kg	4,3 - 4,9 kg	4,5 - 5,1 kg	4,5 - 5,1 kg
Prijs in €	excl. btw				
	incl. btw				

UH006G / UH007G

ACCU HEGGENSCHAREN 40VMAX 'TERUGSNOEIVERSIE'



PROMO

gratis AS001GZ na online registratie UH006GM201 & UH007GM201



UH006GM201

		UH006GZ	UH006GM201	UH007GZ	UH007GM201
Uitvoering		Terugsnoei	Terugsnoei	Terugsnoei	Terugsnoei
Mes		Dubbelzijdig	Dubbelzijdig	Dubbelzijdig	Dubbelzijdig
Bijgeleverde accu's		-	2x BL4040	-	2x BL4040
Bijgeleverde lader		-	DC40RA	-	DC40RA
Aantal snijbewegingen		2000/3000/4000 min ⁻¹	2000/3000/4000 min ⁻¹	2000/3000/4000 min ⁻¹	2000/3000/4000 min ⁻¹
Snijlengte		60 cm	60 cm	75 cm	75 cm
Max. takdikte		25 mm	25 mm	25 mm	25 mm
Max. uitgangsvermogen		720 W	720 W	720 W	720 W
Gewicht		4,4 - 5,0 kg	4,4 - 5,0 kg	4,6 - 5,2 kg	4,6 - 5,2 kg
Prijs in €	excl. btw				
	incl. btw				

UN460W / DUN461 / DUN500

ACCU STOKHEGGENSCHAREN (CXT/LXT)

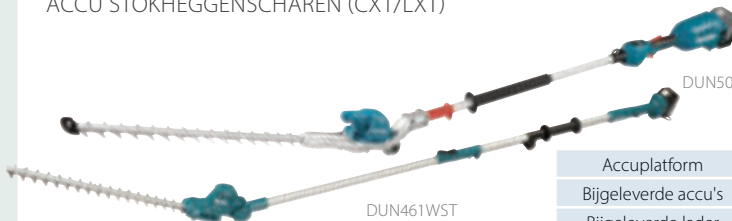

DUN461WST

DUN500WZ

DUN500WZ (520 W)

- Instelbaar in 6 hoeken
- Dubbele greep voor extra comfort
- Innovatieve tandengeometrie
- Totale lengte: 2,1 m

DUN461

- Klassieke tandengeometrie
- Telescopische steel 1,9 m en 2,5 m

		UN460WDZ	UN460WDWA	DUN461WZ	DUN461WST	DUN500WZ
Accuplatform		12Vmax (CXT)	12Vmax (CXT)	18 V (LXT)	18 V (LXT)	18 V (LXT)
Bijgeleverde accu's		-	1 x accu 2,0 Ah	-	1 x accu 5,0 Ah	-
Bijgeleverde lader		-	DC10WD	-	DC18SD	-
Snijlengte		46 cm	46 cm	46 cm	46 cm	50 cm
Maximale takdikte		18 mm	18 mm	18 mm	18 mm	23,5 mm
Totale lengte		1,889 - 2,511 mm	1,889 - 2,511 mm	1,889 - 2,511 mm	1,889 - 2,511 mm	2,115 mm
BL motor		-	-	-	-	✓
Aantal snijbewegingen		3600 min ⁻¹	3600 min ⁻¹	3600 min ⁻¹	3600 min ⁻¹	2000/3600/4400 min ⁻¹
Omkeerfunctie		✓	✓	✓	✓	✓
Gewicht		2,8 - 3,0 kg	2,8 - 3,0 kg	3,0 - 3,3 kg	3,4 kg	3,9 - 4,3 kg
Prijs in €	excl. btw					
	incl. btw					

LM001C

GRASMAAIER MET RECHTSTREEKSE VOEDING VIA ACCUPACK



3 INSTELLINGEN :
- STANDAARD
- SOFT NO LOAD
- STILLE WERKING



LM001CZ



ENERGIEZUINIG MESONTWERP (onderkant toestel)

BL MOTOR **XPT** **SOFT NOLOAD**
EXTREME PROTECTION TECHNOLOGY



LM001C MET MONTAGE VAN PDC01 / PDC1200 (Draagbaar accupack niet inbegrepen)

		LM001CZ
Platform		Accupack
Max. uitgangsvermogen		1600 W
Maaibreedte		53 cm
Maaihogte		20 - 100 mm
Inhoud opvangbak		70 l
Mulching		✓
Zelftrekkend		✓
Chassis		Staal
Aanbevolen oppervlakte		1500 - 3000 m ²
Gewicht		41,9 kg
Prijs in €	excl. btw	
	incl. btw	

ACCESSOIRES BIJ DRAAGBAAR ACCUPACK

Adapter:
ref. 191N62-4



Niet alleen voor gebruik met machines met directe aansluiting

Adapter:
ref. 191J51-5



Ook standaard machines die werken met 40Vmax, 2 x 18V of 18V accu's kunnen op het accupack aangesloten worden middels de juiste adapter.

Adapter:
ref. 191J50-7



PDC1200

met geïntegreerde accu voor 36V/40Vmax

PDC01

kan tot 4 18V accu's bevatten



Werkt uitsluitend met Makita's draagbare accupack

UV3200 / UV3600

ELEKTRISCHE VERTICUTEERMACHINES

UV3200



UV3600



		UV3200	UV3600
Nominaal vermogen		1300 W	1800 W
Werkbreedte		32 cm	36 cm
Polypropyleen chassis		✓	✓
Gewicht		15 kg	18,3 kg
Prijs in €	excl. btw		
	incl. btw		

DLM536 / DLM533

ACCU GRASMAAIERS 2 x 18V

PROMO

Gratis BL1850B na online registratie

18V + 18V → 36V

XPT
EXTREME PROTECTION TECHNOLOGY

BL
MOTOR



DLM536Z



DLM533Z

	DLM536Z	DLM533Z
Spanning	2x 18V	2x 18V
Bijgeleverde lader	-	-
Bijgeleverde accu's	-	-
Max. uitgangsvermogen	1600 W	1600 W
Maai breedte	53 cm	53 cm
Aanbevolen terreinoppervlakte	1600 - 1800 m ²	1600 - 1800 m ²
Chassis	Staal	Aluminium
Zelftrekkend	✓	✓
Inhoud opvangbak	60 l	60 l
Mulching	✓	✓
Gewicht	39,0 - 42,8 kg	39,0 - 42,8 kg
Prijs in €	excl. btw	
	incl. btw	

LM001G / LM002G

ACCU GRASMAAIERS 40VMAX

XGT

XGT
40Vmax

BL
MOTOR

SOFT
NO LOAD

WG
WETGUARD

PROMO

Gratis BL4040 direct geleverd bij LM001GZ & LM002GZ



3 snelheden: standaard, stil en automatisch (soft no load).

Nieuwe krachtige BL-motor met buitenrotor, speciaal ontwikkeld voor grasmaaiers.

Voeding met twee XGT accu's in parallel (36 V). Automatische overschakeling wanneer één accu leeg is

Grote wielen Ø 230 mm voor betere tractie en comfortabel rijden op oneffen terrein.

Robuust stalen maaidek

Traploos regelbare snelheid met groot bereik (0,5 tot 1,5 km/h).

Stevige duwhendel opvouwbaar zonder gereedschap.

Grote opvangcapaciteit. Standaard met mulching plug en een plug voor grasuitworp achteraan.

Wetguard/IPX/4 compatibel Constructie met uitstekende bestendigheid tegen indringing van water.

Het standaard mes is geschikt voor mulchen en grasopvang. Speciale maaimessen zijn afzonderlijk verkrijgbaar

	LM001GZ	LM002GZ
Spanning	36 V (40Vmax)	36 V (40Vmax)
Max. uitgangsvermogen	1900 W	1900 W
Maai breedte	48 cm	53 cm
Aanbevolen terreinoppervlakte	1600 - 1800 m ²	1700 - 2000 m ²
Toerental onbelast	2500 / 3200 min ⁻¹	2300 / 2800 min ⁻¹
Maaihoogte	20 - 100 mm	20 - 100 mm
Rijsnelheid	1,5 - 5,0 km/h	1,5 - 5,0 km/h
Opvangcapaciteit	62 l	70 l
Gewicht	28,0 - 33,0 kg	29,5 - 34,7 kg
Prijs in €	excl. btw	
	incl. btw	

DLM330

ACCU GRASMAAIERS 18V



DLM330SM

	DLM330Z	DLM330SM
Spanning	1 x 18V	1 x 18V
Bijgeleverde accu's	-	1 x accu 4,0 Ah
Bijgeleverde Lader	-	DC18SD
Max. uitgangsvermogen	450 W	450 W
Maaibreedte	33 cm	33 cm
Aanbevolen terreinoppervlakte	200 - 450 m ²	200 - 450 m ²
Chassis	Polypropyleen	Polypropyleen
Zelftrekkend		
Inhoud opvangbak	30 l	30 l
Mulching	✓	✓
Gewicht	11,6 - 12,5 kg	11,6 - 12,5 kg
Prijs in €	excl. btw	
	incl. btw	

DLM432

ACCU GRASMAAIERS 2 x 18V



DLM432PT2

	DLM432Z	DLM432PT2
Spanning	2 x 18V	2 x 18V
Bijgeleverde accu's	-	2 x accu 5,0 Ah
Bijgeleverde Lader	-	DC18RD
Max. uitgangsvermogen	900 W	900 W
Maaibreedte	43 cm	43 cm
Aanbevolen terreinoppervlakte	300 - 575 m ²	300 - 575 m ²
Chassis	Polypropyleen	Polypropyleen
Zelftrekkend	-	-
Inhoud opvangbak	50 l	50 l
Mulching	Optioneel	Optioneel
Gewicht	14,3 kg	14,3 kg
Prijs in €	excl. btw	
	incl. btw	

"Max aanbevolen maaiooppervlakte" is de maximum oppervlakte waar de machine qua vermogen, mechaniek en werkbreedte voor geschikt is. Opgelet, dit komt niet noodzakelijk overeen met de autonomie, die afhankelijk is van het type batterijen dat gebruikt wordt en de maaiomstandigheden (de hoogte en dichtheid van het gras, de helling van het terrein enz.) Dus het kan voorkomen dat de accu's tussenin bijgeladen moeten worden om de volledige oppervlakte te kunnen maaien.

DLM480 / DLM481 / DLM539

ACCU GRASMAAIERS 2 x 18V

PROMO

Gratis BL1850B na online registratie DLM481CT2 en DLM539CT2



DLM481CT2



DLM539CT2

	DLM480CT2	DLM481CT2	DLM539CT2
Spanning	2 x 18V	2 x 18V	2 x 18V
Bijgeleverde accu's	2 x accu 5,0 Ah	2 x accu 5,0 Ah	2 x accu 5,0 Ah
Bijgeleverde Lader	DC18SH	DC18SH	DC18SH
Max. uitgangsvermogen	860 W	860 W	860 W
Maaibreedte	48 cm	48 cm	53,4 cm
Aanbevolen terreinoppervlakte	400 - 800 m ²	400 - 800 m ²	500 - 1000 m ²
Chassis	Polypropyleen	Polypropyleen	Polypropyleen
Zelftrekkend	-	✓	✓
Inhoud opvangbak	62 l	62 l	70 l
Mulching	✓	✓	✓
Gewicht	24,5 - 26,8 kg	27,1 - 29,3 kg	28,0 - 30,5 kg
Prijs in €	excl. btw		
	incl. btw		

DLM463 / DLM465

ACCU GRASMAAIERS 2 x 18V

PROMO

Gratis BL1850B na online registratie



DLM463PT2

DLM465PT2

	DLM463Z	DLM463PT2	DLM465Z	DLM465PT2
Spanning	2x 18V	2x 18V	2x 18V	2x 18V
Bijgeleverde accu's	-	2x 5,0 Ah	-	2x 5,0 Ah
Bijgeleverde lader	-	DC18RD	-	DC18RD
Max. uitgangsvermogen	1450 W	1450 W	1600 W	1600 W
Maaibreedte	46 cm	46 cm	46 cm	46 cm
Aanbevolen terreinoppervlakte	800 - 1600 m ²	800 - 1600 m ²	1600 - 1800 m ²	1600 - 1800 m ²
Chassis	Staal	Staal	Staal	Staal
Zelftrekkend	-	-	✓	✓
Inhoud opvangbak	60 l	60 l	60 l	60 l
Mulching	✓	✓	✓	✓
Gewicht	25,3 - 27,6 kg	25,3 - 27,6 kg	35,3 - 39,0 kg	35,3 - 39,0 kg
Prijs in €	excl. btw			
	incl. btw			

UB101D

ACCU BLAZER 12VMAX



UB101DZ

Spanning	10,8 V (12Vmax)
Bijgeleverde accu's	-
Bijgeleverde lader	-
Luchtsnelheid	65 m/s
Max. debiet	2,6 m³/min
Max. blaaskracht	1,6 N
Gewicht	1,4 - 1,9 kg
Prijs in €	excl. btw
	incl. btw

DUB186

ACCU BLAZER 18V



DUB186Z

Spanning	18 V
Bijgeleverde accu's	-
Bijgeleverde lader	-
Luchtsnelheid	56 m/s
Max. debiet	3,2 m³/min
Max. blaaskracht	2,5 N
Gewicht	1,6 - 2,1 kg
Prijs in €	excl. btw
	incl. btw

DUB184

ACCU BLADBLAZER 18 V



DUB184Z

DUB184RT

Spanning	18V	18V
Bijgeleverde accu's	-	1 x BL1850B
Bijgeleverde lader	-	DC18RC
Luchtsnelheid	49 m/s	49 m/s
Max. debiet	12,7 m³/min	12,7 m³/min
Max. blaaskracht	10,9 N	10,9 N
Gewicht	2.5 - 3.0 kg	2.5 - 3.0 kg
Prijs in €	excl. btw	
	incl. btw	

DUB362

ACCU BLADBLAZER 2 x 18 V



DUB362Z

DUB362TX1

Spanning	2x18V	2x18V
Bijgeleverde accu's	-	4 x BL1850B
Bijgeleverde lader	-	DC18RD
Luchtsnelheid	54 m/s	54 m/s
Max. debiet	13,4 m³/min	13,4 m³/min
Max. blaaskracht	14,4 N	14,4 N
Gewicht	3.5 - 4.2 kg	3.5 - 4.2 kg
Prijs in €	excl. btw	
	incl. btw	

UB001G

ACCU BLADBLAZER 40VMAX



PROMO

gratis AS001GZ na online registratie UB001GM101



UB001GZ

UB001GM101

Spanning	36V (40Vmax)	36V (40Vmax)
Bijgeleverde accu's	-	1x BL4040
Bijgeleverde lader	-	DC40RA
Luchtsnelheid	64 m/s	64 m/s
Max. debiet	16,0 m³/min	16,0 m³/min
Max. blaaskracht	12 N (17 N boost)	12 N (17 N boost)
Gewicht	3,1 - 3,9 kg	3,1 - 3,9 kg
Prijs in €	excl. btw	
	incl. btw	

DUB363

ACCU BLADBLAZER / -ZUIGER 2 x 18 V



Geleverd met bladzuigset

DUB363ZV

Spanning	2 x 18V
Bijgeleverde accu's	-
Bijgeleverde lader	-
Luchtsnelheid	54 m/s
Max. debiet	13,4 m³/min
Max. blaaskracht	14,4 N
Gewicht	4,5 - 6,6 kg
Prijs in €	excl. btw
	incl. btw

DUB187

ACCU BLADBLAZER / - ZUIGER 18V



- Budgetvriendelijke bladzuiger / blazer
- Variabele snelheid en "cruise control" (aanhouden gekozen snelheid)
- Turbine met verhaakselmes
- Omschakelen van zuigen naar blazen met slechts één hendel



DUB187T001

	NIEUW	NIEUW
	DUB187Z	DUB187T001
Spanning	18V	18V
Bijgeleverde accu's	-	BL1850B
Bijgeleverde lader	-	DC18WC
Luchtsnelheid (blazen)	64 m/s	64 m/s
Max. debiet (zuigen)	6,1 m ³ /min	6,1 m ³ /min
Max. onderdruk	33 mbar	33 mbar
Max. blaaskracht	4,2 N	4,2 N
Gewicht	3,7 - 4,0 kg	3,7 - 4,0 kg
Prijs in €	excl. btw	
	incl. btw	

Optioneel accessoire

GB00000165

T-vormig mondstuk geschikt voor DUB187 (excl. btw) / (incl. btw)



UB001CZ

BLADBLAZER MET DIRECTE AANSLUITING OP ACCUPACK



ENKEL AANSLUITBAAR OP DRAAGBAAR ACCUPACK PDC/01 / PDC1200

AANGEPASTE LUCHTSTROOM VOOR BETERE PRESTATIES EN MEER GEBRUIKSGEMAK

LAAG GELUIDSNIVEAU LICHTGEWICHT



UB001CZ	
Platform	Accupack PDC01 of PDC1200
Max. luchtsnelheid	70 m/s
Max. debiet	17,6 m ³ /min
Max. blaaskracht	15 N (20 N boost)
Gewicht	2,6 kg
Prijs in €	excl. btw
	incl. btw

UB002CZ

RUGGEDRAGEN BLADBLAZER MET RECHTSTREEKSE AANSLUITING OP ACCUPACK



ACCU NIET INBEGREPEN!



Het accupack kan in één beweging op de machine vastgeklkt worden.



Triggerschakelaar met variabele snelheid en "cruise control" hendel.



De bedieningshendel kan horizontaal verschoven en gekanteld worden.

UB002CZ	
Platform	Accupack PDC1200
Luchtsnelheid	71,7 m/s
Max. debiet	19 m ³ /min
Max. blaaskracht	20 N (22 N boost)
Geluidsdruk niveau	81 dB (A)
Gewicht	15,9 - 16,1 kg
Prijs in €	excl. btw
	incl. btw