



METALEN LEIDINGEN & FITTINGEN
CATALOGUS



Stockvoorraad van onze producten

Vetgedrukt

- Direct leverbaar of verkrijgbaar in ons magazijn:
Ovenstraat 11, 8800 Roeselare, Belgium
-

Normaal gedrukt

- Metalen leidingen en fittingen die we beperkt op voorraad hebben.
 - Metalen leidingen en fittingen die enkel op aanvraag beschikbaar zijn.
-

Overige producten

Heb je een fitting gezien die niet vermeld staat in deze catalogus dan is de kans groot dat ook dit product bij **DEMA** te verkrijgen is.

Vraag raad aan onze specialisten. Zij zoeken samen met jou naar de beste oplossing.

INHOUDSOPGAVE

VERZINKTE BUIZEN & FITTINGEN	9
Verzinkte buizen	12
Verzinkte draadfittingen	13
Verzinkte pijpnippels	33
Verzinkte flenzen	35
Rubber compensatoren	36
ZWARTE DRAAD- & LASFITTINGEN	37
Stalen buizen	40
Zwarte draadfittingen	41
Zwarte pijpnippels	50
Zwarte lasfittingen	52
Zwarte lastules	57
Stalen flenzen	58
MESSING DRAADFITTINGEN	61
RVS DRAAD- & LASFITTINGEN	79
Gelaste RVS buizen	82
RVS draadfittingen	83
RVS pijpnippels	92
RVS lasfittingen	94
RVS lastules	98
RVS flenzen	99
TECHNISCHE INFO	103
Draadtabellen	105
Flensafmetingen	106

“ Wij zijn een klantgerichte leverancier met een regen van oplossingen voor industrie en landbouw.

Dema evolueerde door de jaren heen van een belangrijke speler in beregening voor de land- en tuinbouw, tot een gereputeerde partner voor de brede industrie, door de stelselmatige uitbreiding van het assortiment.

Bij ons kan u onder meer terecht voor waterpompen, leidingsystemen, industriële slangen, koppelingen, lagers, slijtdelen, afsluiters en appendages, bevestigingsmaterialen en PBM's.

Door alle technische informatie op een duidelijke manier over te brengen en dit zowel telefonisch, via mail of in onze winkel in Roeselare, maken onze gespecialiseerde medewerkers u wegwijs in een stock van liefst 80.000 referenties. We helpen met u meedenken en zoeken samen naar oplossingen voor de technische uitdagingen waarmee uw bedrijf dagdagelijks mee geconfronteerd wordt.

Dema staat ook in voor het uitvoeren van herstellingen aan pompen en machines en timmert voortdurend aan het optimaliseren van de logistieke organisatie.

Kom langs en laat u verrassen door ons uitgebreide aanbod.



Oprichting
Dema-shop in
Ardoorie



1985

Verhuis naar de
huidige vestiging in de
Ovenstraat te Roeselare



1994

PVC-U drukbuizen,
PE-leidingen en
beregeningshaspels
op voorraad



2002

Optimalisatie van
het aanbod en
uitbreiding van de
voorraad



2008

Nieuwe huisstijl
& website



2014

Vergroten van het
industriële aanbod
met rollagers,
lagerhuizen en
aandrijfkettingen



2016

Opstart eigen transport &
vertegenwoordiging op baan



2017

Vervolledigen van
het landbouw
gamma door het
aanleggen van een
ruime voorraad
slijtstukken voor
grondbewerking



2018

Uitbreiding 'dienst
na verkoop' &
hersteldienst



2020

Start bouw
nieuw magazijn



2022

Lancering
webportaal



2023

Uitbreiding
watertechnieken



2024

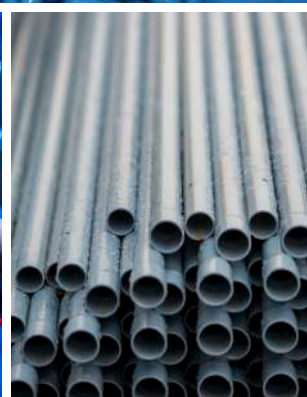



— DEEL 1 —

VERZINKTE BUIZEN & FITTINGEN

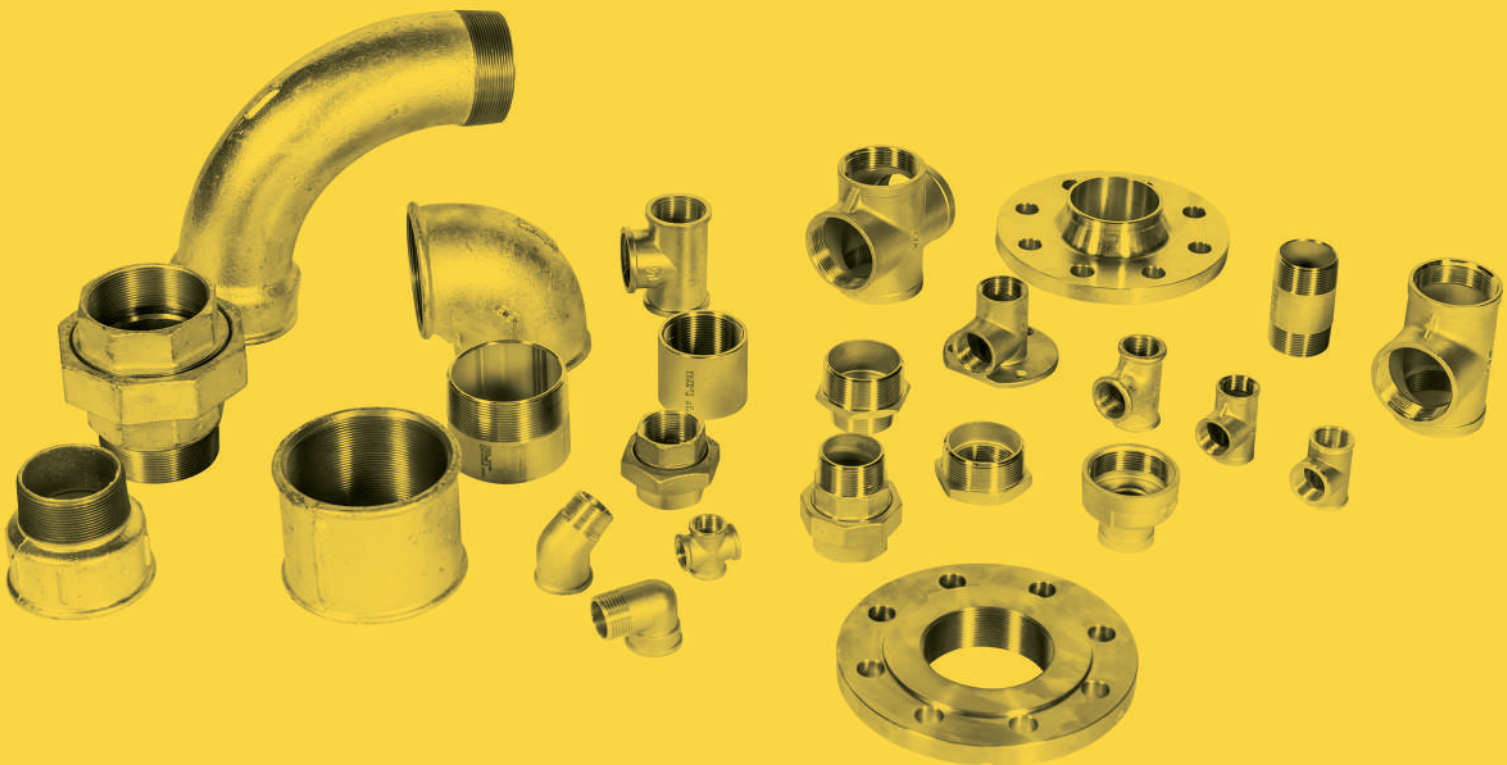

VERZINKTE BUIZEN & FITTINGEN

— MALLEABEL —

Verzinkte buizen	12
Verzinkte draadfittingen	13
Verzinkte pijpnippels	33
Verzinkte flenzen	35
Rubber compensatoren	36

VERZINKTE BUIZEN & FITTINGEN

VERZINKTE BUIZEN

VERZINKTE BUIZEN & FITTINGEN



VERZINKTE BUIS

GLAD

Bestelnr	Maat	Wanddikte	Lengte
GB38	3/8"	2,30 mm	6 m
GB12	1/2"	2,60 mm	6 m
GB34	3/4"	2,60 mm	6 m
GB1	1"	3,20 mm	6 m
GB54	5/4"	3,20 mm	6 m
GB64	6/4"	3,20 mm	6 m
GB2	2"	3,60 mm	6 m
GB25	2 1/2"	3,60 mm	6 m
GB3	3"	4,00 mm	6 m
GB4	4"	4,50 mm	6 m

NR 1 - LANGE BOCHT 90°

BINNENDRAAD - BUITENDRAAD

Bestelnr	Maat
ZF118	1/8"
ZF114	1/4"
ZF138	3/8"
ZF112	1/2"
ZF134	3/4"
ZF11	1"
ZF154	5/4"
ZF164	6/4"
ZF12	2"
ZF125	2 1/2"
ZF13	3"
ZF14	4"

VERZINKTE BUIZEN & FITTINGEN

VERZINKTE DRAADFITTINGEN



NR 2 - LANGE BOCHT 90°

2X BINNENDRAAD

Bestelnr	Maat
ZF214	1/4"
ZF238	3/8"
ZF212	1/2"
ZF234	3/4"
ZF21	1"
ZF254	5/4"
ZF264	6/4"
ZF22	2"
ZF225	2 1/2"
ZF23	3"
ZF24	4"

NR 3 - LANGE BOCHT 90°

2X BUITENDRAAD

Bestelnr	Maat
ZF338	3/8"
ZF312	1/2"
ZF334	3/4"
ZF31	1"
ZF354	5/4"
ZF364	6/4"
ZF32	2"

VERZINKTE BUIZEN & FITTINGEN

VERZINKTE DRAADFITTINGEN



NR 40 - BOCHT 45°

BINNENDRAAD - BUITENDRAAD

Bestelnr	Maat
ZF4038	3/8"
ZF4012	1/2"
ZF4034	3/4"
ZF401	1"
ZF4054	5/4"
ZF4064	6/4"
ZF402	2"
ZF4025	2 1/2"
ZF403	3"
ZF404	4"



NR 41 - BOCHT 45°

2X BINNENDRAAD

Bestelnr	Maat
ZF4112	1/2"
ZF4134	3/4"
ZF411	1"
ZF4114	1/4"
ZF4154	5/4"
ZF4164	6/4"
ZF412	2"
ZF4125	2 1/2"
ZF413	3"

VERZINKTE BUIZEN & FITTINGEN

VERZINKTE DRAADFITTINGEN



NR 90 - KNIE 90°

2X BINNENDRAAD

Bestelnr	Maat
ZF9018	1/8"
ZF9014	1/4"
ZF9038	3/8"
ZF9012	1/2"
ZF9034	3/4"
ZF901	1"
ZF9054	5/4"
ZF9064	6/4"
ZF902	2"
ZF9025	2 1/2"
ZF903	3"
ZF904	4"



NR 90R - REDUCTIEKNIE 90°

2X BINNENDRAAD

Bestelnr	Maat
ZF90R3814	3/8" x 1/4"
ZF90R1214	1/2" x 1/4"
ZF90R1238	1/2" x 3/8"
ZF90R3414	3/4" x 1/4"
ZF90R3438	3/4" x 3/8"
ZF90R3412	3/4" x 1/2"
ZF90R112	1" x 1/2"
ZF90R134	1" x 3/4"
ZF90R5412	5/4" x 1/2"
ZF90R5434	5/4" x 3/4"
ZF90R541	5/4" x 1"
ZF90R6412	6/4" x 1/2"
ZF90R6434	6/4" x 3/4"
ZF90R641	6/4" x 1"
ZF90R6454	6/4" x 5/4"
ZF90R212	2" x 1/2"
ZF90R234	2" x 3/4"
ZF90R21	2" x 1"
ZF90R254	2" x 5/4"
ZF90R264	2" x 6/4"
ZF90R2564	2 1/2" x 6/4"
ZF90R252	2 1/2" x 2"
ZF90R364	3" x 6/4"
ZF90R32	3" x 2"
ZF90R325	3" x 2 1/2"

VERZINKTE BUIZEN & FITTINGEN

VERZINKTE DRAADFITTINGEN

VERZINKTE BUIZEN & FITTINGEN



NR 92 - KNIE 90°

BINNENDRAAD - BUITENDRAAD

Bestelnr	Maat
ZF9218	1/8"
ZF9214	1/4"
ZF9238	3/8"
ZF9212	1/2"
ZF9234	3/4"
ZF921	1"
ZF9254	5/4"
ZF9264	6/4"
ZF922	2"
ZF9225	2 1/2"
ZF923	3"
ZF924	4"

NR 94 - KNIE 90°

2X BUITENDRAAD

Bestelnr	Maat
ZF9412	1/2"
ZF9434	3/4"
ZF941	1"
ZF9454	5/4"
ZF9464	6/4"
ZF942	2"



NR 92R - REDUCTIEKNIE 90°

BINNENDRAAD - BUITENDRAAD

Bestelnr	Maat
ZF92R1238	1/2" x 3/8"
ZF92R3412	3/4" x 1/2"
ZF92R134	1" x 3/4"
ZF92R3812	3/8" x 1/2"
ZF92R541	5/4" x 1"

VERZINKTE BUIZEN & FITTINGEN

VERZINKTE DRAADFITTINGEN



NR 96 - KNIKOPPELING

2X BINNENDRAAD

Bestelnr	Maat
ZF9614	1/4"
ZF9638	3/8"
ZF9612	1/2"
ZF9634	3/4"
ZF961	1"
ZF9654	5/4"
ZF9664	6/4"
ZF962	2"
ZF9625	2 1/2"
ZF963	3"



NR 98 - KNIKOPPELING 90°

BINNENDRAAD - BUITENDRAAD

Bestelnr	Maat
ZF9814	1/4"
ZF9838	3/8"
ZF9812	1/2"
ZF9834	3/4"
ZF981	1"
ZF9854	5/4"
ZF9864	6/4"
ZF982	2"
ZF9825	2 1/2"
ZF983	3"

VERZINKTE BUIZEN & FITTINGEN

VERZINKTE BUIZEN & FITTINGEN

VERZINKTE DRAADFITTINGEN

VERZINKTE BUIZEN & FITTINGEN



NR 120 - KNIE 45°

2X BINNENDRAAD

Bestelnr	Maat
ZF12038	3/8"
ZF12012	1/2"
ZF12034	3/4"
ZF1201	1"
ZF12054	5/4"
ZF12064	6/4"
ZF1202	2"
ZF12025	2 1/2"
ZF1203	3"



NR 121 - KNIE 45°

BINNENDRAAD - BUITENDRAAD

Bestelnr	Maat
ZF12138	3/8"
ZF12112	1/2"
ZF12134	3/4"
ZF1211	1"
ZF12154	5/4"
ZF12164	6/4"
ZF1212	2"
ZF12125	2 1/2"
ZF1213	3"

VERZINKTE BUIZEN & FITTINGEN

VERZINKTE DRAADFITTINGEN



NR 130 - T-STUK 90°

3X BINNENDRAAD

Bestelnr	Maat
ZF13018	1/8"
ZF13014	1/4"
ZF13038	3/8"
ZF13012	1/2"
ZF13034	3/4"
ZF1301	1"
ZF13054	5/4"
ZF13064	6/4"
ZF1302	2"
ZF13025	2 1/2"
ZF1303	3"
ZF1304	4"



NR 130R - VERLOOP T-STUK 90°

3X BINNENDRAAD

Bestelnr	Maat
ZF1303814	3/8" x 1/4" x 3/8"
ZF13381238	3/8" x 1/2" x 3/8"
ZF1301214	1/2" x 1/4" x 1/2"
ZF13123838	1/2" x 3/8" x 3/8"
ZF1301238	1/2" x 3/8" x 1/2"
ZF13121238	1/2" x 1/2" x 3/8"
ZF13123412	1/2" x 3/4" x 1/2"
ZF1312112	1/2" x 1" x 1/2"
ZF1303414	3/4" x 1/4" x 3/4"
ZF13343812	3/4" x 3/8" x 1/2"
ZF1303438	3/4" x 3/8" x 3/4"
ZF13341212	3/4" x 1/2" x 1/2"
ZF13341238	3/4" x 1/2" x 3/8"
ZF1303412	3/4" x 1/2" x 3/4"
ZF13343438	3/4" x 3/4" x 3/8"
ZF13343412	3/4" x 3/4" x 1/2"
ZF1334112	3/4" x 1" x 1/2"
ZF1334134	3/4" x 1" x 3/4"
ZF130114	1" x 1/4" x 1"
ZF130138	1" x 3/8" x 1"
ZF1311212	1" x 1/2" x 1/2"
ZF1311234	1" x 1/2" x 3/4"
ZF130112	1" x 1/2" x 1"
ZF1313412	1" x 3/4" x 1/2"
ZF1313434	1" x 3/4" x 3/4"
ZF130134	1" x 3/4 x 1"
ZF131138	1" x 1" x 3/8"
ZF131112	1" x 1" x 1/2"
ZF131134	1" x 1" x 3/4"
ZF1315434	1" x 5/4" x 3/4"
ZF131541	1" x 5/4" x 1"
ZF131641	1" x 6/4" x 1"
ZF1305438	5/4" x 3/8" x 5/4"
ZF1354121	5/4" x 1/2" x 1"
ZF1305412	5/4" x 1/2" x 5/4"
ZF13543434	5/4" x 3/4" x 3/4"
ZF1354341	5/4" x 3/4" x 1"
ZF1305434	5/4" x 3/4" x 5/4"

VERZINKTE BUIZEN & FITTINGEN

VERZINKTE BUIZEN & FITTINGEN

VERZINKTE DRAADFITTINGEN



NR 130R - VERLOOP T-STUK 90°

3X BINNENDRAAD

Bestelnr	Maat
ZF1354134	5/4" x 1" x 3/4"
ZF135411	5/4" x 1" x 1"
ZF130541	5/4" x 1" x 5/4"
ZF1354541	5/4" x 5/4" x 1"
ZF13545412	5/4" x 5/4" x 1/2"
ZF13545434	5/4" x 5/4" x 3/4"
ZF13546454	5/4" x 6/4" x 5/4"
ZF1354254	5/4" x 2" x 5/4"
ZF13641234	6/4" x 1/2" x 3/4"
ZF13641254	6/4" x 1/2" x 5/4"
ZF1306412	6/4" x 1/2" x 6/4"
ZF13643454	6/4" x 3/4" x 5/4"
ZF1306434	6/4" x 3/4" x 6/4"
ZF136411	6/4" x 1" x 1"
ZF1364154	6/4" x 1" x 5/4"
ZF130641	6/4" x 1" x 6/4"
ZF1364541	6/4" x 5/4" x 1"
ZF13645454	6/4" x 5/4" x 5/4"
ZF1306454	6/4" x 5/4" x 6/4"
ZF13646412	6/4" x 6/4" x 1/2"
ZF13646434	6/4" x 6/4" x 3/4"
ZF1364641	6/4" x 6/4" x 1"
ZF13646454	6/4" x 6/4" x 5/4"
ZF1364264	6/4" x 2" x 6/4"
ZF1321264	2" x 1/2" x 6/4"
ZF130212	2" x 1/2" x 2"
ZF1323464	2" x 3/4" x 6/4"
ZF130234	2" x 3/4" x 2"
ZF132164	2" x 1" x 6/4"
ZF13021	2" x 1" x 2"
ZF1325454	2" x 5/4" x 5/4"
ZF1325464	2" x 5/4" x 6/4"
ZF130254	2" x 5/4" x 2"
ZF1326464	2" x 6/4" x 6/4"
ZF130264	2" x 6/4" x 2"

NR 130R - VERLOOP T-STUK 90°

3X BINNENDRAAD

Bestelnr	Maat
ZF132212	2" x 2" x 1/2"
ZF132234	2" x 2" x 3/4"
ZF13221	2" x 2" x 1"
ZF132254	2" x 2" x 5/4"
ZF132264	2" x 2" x 6/4"
ZF132252	2" x 2 1/2" x 2"
ZF1302512	2 1/2" x 1/2" x 2 1/2"
ZF1302534	2 1/2" x 3/4" x 2 1/2"
ZF130251	2 1/2" x 1" x 2 1/2"
ZF1325642	2 1/2" x 6/4" x 2"
ZF1302564	2 1/2" x 6/4" x 2 1/2"
ZF132522	2 1/2" x 2" x 2"
ZF130252	2 1/2" x 2" x 2 1/2"
ZF1325252	2 1/2" x 2 1/2" x 2"
ZF130312	3" x 1/2" x 3"
ZF130334	3" x 3/4" x 3"
ZF13031	3" x 1" x 3"
ZF1302554	3" x 5/4" x 2 1/2"
ZF130354	3" x 5/4" x 3"
ZF130364	3" x 6/4" x 3"
ZF13322	3" x 2" x 2"
ZF13032	3" x 2" x 3"
ZF130325	3" x 2 1/2" x 3"
ZF13041	4" x 1" x 4"
ZF130454	4" x 5/4" x 4"
ZF130464	4" x 6/4" x 4"
ZF13042	4" x 2" x 4"
ZF130425	4" x 2 1/2" x 4"
ZF13043	4" x 3" x 4"

VERZINKTE BUIZEN & FITTINGEN

VERZINKTE DRAADFITTINGEN



NR 131 - VLOEI T-STUK 90° (ENKEL)

3X BINNENDRAAD

Bestelnr	Maat
ZF13112	1/2"
ZF13134	3/4"
ZF1311	1"
ZF13154	5/4"
ZF13164	6/4"
ZF1312	2"
ZF13125	2 1/2"
ZF1313	3"
ZF1314	4"



NR 133 - T-STUK 90°

VROUWELIJK - MANNELIJK - VROUWELIJK

Bestelnr	Maat
ZF13312	1/2"
ZF13334	3/4"
ZF1331	1"



NR 132 - VLOEI T-STUK (DUBBEL)

3X BINNENDRAAD

Bestelnr	Maat
ZF13212	1/2"
ZF13234	3/4"
ZF1321	1"
ZF13254	5/4"
ZF13264	6/4"
ZF1322	2"



NR 134 - T-STUK 90°

VROUWELIJK - VROUWELIJK - MANNELIJK

Bestelnr	Maat
ZF13414	1/4"
ZF13438	3/8"
ZF13412	1/2"
ZF13434	3/4"
ZF1341	1"
ZF13454	5/4"
ZF13464	6/4"

VERZINKTE BUIZEN & FITTINGEN

VERZINKTE DRAADFITTINGEN

VERZINKTE BUIZEN & FITTINGEN



NR 180 - KRUISSTUK

4X BINNENDRAAD

Bestelnr	Maat
ZF18014	1/4"
ZF18038	3/8"
ZF18012	1/2"
ZF18034	3/4"
ZF1801	1"
ZF18054	5/4"
ZF18064	6/4"
ZF1802	2"
ZF18025	2 1/2"
ZF1803	3"
ZF1804	4"



NR 165 - T-STUK 45°

3X BINNENDRAAD

Bestelnr	Maat
ZF16512	1/2"
ZF16534	3/4"
ZF1651	1"
ZF16554	5/4"
ZF16564	6/4"
ZF1652	2"



NR 220 - Y-STUK

3X BINNENDRAAD

Bestelnr	Maat
ZF22038	3/8"
ZF22012	1/2"
ZF22034	3/4"
ZF2201	1"

VERZINKTE BUIZEN & FITTINGEN

VERZINKTE DRAADFITTINGEN



VERZINKTE BUIZEN & FITTINGEN

NR 221 - KNIE MET ZIJSPRUIT

3X BINNENDRAAD

Bestelnr	Maat
ZF22138	3/8"
ZF22112	1/2"
ZF22134	3/4"
ZF2211	1"
ZF22154	5/4"
ZF22164	6/4"
ZF2212	2"

NR 223 - KNIE MET 2 ZIJSPRUITEN

4X BINNENDRAAD

Bestelnr	Maat
ZF22312	1/2"
ZF22334	3/4"
ZF2231	1"

VERZINKTE BUIZEN & FITTINGEN

VERZINKTE DRAADFITTINGEN



VERZINKTE BUIZEN & FITTINGEN

NR 240 - VERLOOPMOF

2X BINNENDRAAD

Bestelnr	Maat
ZF2401418	1/4" x 1/8"
ZF2403818	3/8" x 1/8"
ZF2403814	3/8" x 1/4"
ZF2401214	1/2" x 1/4"
ZF2401238	1/2" x 3/8"
ZF2403414	3/4" x 1/4"
ZF2403438	3/4" x 3/8"
ZF2403412	3/4" x 1/2"
ZF240138	1" x 3/8"
ZF240112	1" x 1/2"
ZF240134	1" x 3/4"
ZF2405438	5/4" x 3/8"
ZF2405412	5/4" x 1/2"
ZF2405434	5/4" x 3/4"
ZF240541	5/4" x 1"
ZF2406412	6/4" x 1/2"
ZF2406434	6/4" x 3/4"
ZF240641	6/4" x 1"
ZF2406454	6/4" x 5/4"
ZF240212	2" x 1/2"
ZF240234	2" x 3/4"
ZF24021	2" x 1"
ZF240254	2" x 5/4"
ZF240264	2" x 6/4"
ZF240251	2 1/2" x 1"
ZF2402554	2 1/2" x 5/4"
ZF2402564	2 1/2" x 6/4"
ZF240252	2 1/2" x 2"
ZF24031	3" x 1"
ZF240354	3" x 5/4"
ZF240364	3" x 6/4"
ZF24032	3" x 2"
ZF240325	3" x 2 1/2"
ZF24042	4" x 2"
ZF240425	4" x 2 1/2"
ZF24043	4" x 3"

NR 241 - VERLOOPRING

BUITENDRAAD - BINNENDRAAD

Bestelnr	Maat
ZF2411418	1/4" x 1/8"
ZF2413818	3/8" x 1/8"
ZF2413814	3/8" x 1/4"
ZF2411218	1/2" x 1/8"
ZF2411214	1/2" x 1/4"
ZF2411238	1/2" x 3/8"
ZF2413414	3/4" x 1/4"
ZF2413438	3/4" x 3/8"
ZF2413412	3/4" x 1/2"
ZF241114	1" x 1/4"
ZF241138	1" x 3/8"
ZF241112	1" x 1/2"
ZF241134	1" x 3/4"
ZF2415438	5/4" x 3/8"
ZF2415412	5/4" x 1/2"
ZF2415434	5/4" x 3/4"
ZF241541	5/4" x 1"
ZF2416438	6/4" x 3/8"
ZF2416412	6/4" x 1/2"
ZF2416434	6/4" x 3/4"
ZF241641	6/4" x 1"
ZF2416454	6/4" x 5/4"
ZF241212	2" x 1/2"
ZF241234	2" x 3/4"
ZF24121	2" x 1"
ZF241254	2" x 5/4"
ZF241264	2" x 6/4"
ZF2412534	2 1/2" x 3/4"
ZF241251	2 1/2" x 1"
ZF2412554	2 1/2" x 5/4"
ZF2412564	2 1/2" x 6/4"
ZF241252	2 1/2" x 2"
ZF24131	3" x 1"
ZF241354	3" x 5/4"
ZF241364	3" x 6/4"
ZF24132	3" x 2"

VERZINKTE BUIZEN & FITTINGEN

VERZINKTE DRAADFITTINGEN



VERZINKTE BUIZEN & FITTINGEN

NR 241 - VERLOOPRING

BUITENDRAAD - BINNENDRAAD

Bestelnr	Maat
ZF241325	3" x 2 1/2"
ZF24141	4" x 1"
ZF241454	4" x 5/4"
ZF241464	4" x 6/4"
ZF24142	4" x 2"
ZF241425	4" x 2 1/2"
ZF24143	4" x 3"

NR 245 - VERLOOPNIPPEL

2X BUITENDRAAD

Bestelnr	Maat
ZF2451418	1/4" x 1/8"
ZF2453818	3/8" x 1/8"
ZF2453814	3/8" x 1/4"
ZF2451214	1/2" x 1/4"
ZF2451238	1/2" x 3/8"
ZF2453414	3/4" x 1/4"
ZF2453438	3/4" x 3/8"
ZF2453412	3/4" x 1/2"
ZF245138	1" x 3/8"
ZF245112	1" x 1/2"
ZF245134	1" x 3/4"
ZF2455412	5/4" x 1/2"
ZF2455434	5/4" x 3/4"
ZF245541	5/4" x 1"
ZF2456412	6/4" x 1/2"
ZF2456434	6/4" x 3/4"
ZF245641	6/4" x 1"
ZF2456454	6/4" x 5/4"
ZF245212	2" x 1/2"
ZF245234	2" x 3/4"
ZF24521	2" x 1"
ZF245254	2" x 5/4"
ZF245264	2" x 6/4"
ZF245251	2 1/2" x 1"
ZF2452554	2 1/2" x 5/4"
ZF2452564	2 1/2" x 6/4"
ZF245252	2 1/2" x 2"
ZF24532	3" x 2"
ZF245325	3" x 2 1/2"
ZF24543	4" x 3"

VERZINKTE BUIZEN & FITTINGEN

VERZINKTE DRAADFITTINGEN



NR 246 - SOKNIPPEL

BINNENDRAAD - BUITENDRAAD

Bestelnr	Maat
ZF2461418	1/4" x 1/8"
ZF2463814	3/8" x 1/4"
ZF2461214	1/2" x 1/4"
ZF2461238	1/2" x 3/8"
ZF2463438	3/4" x 3/8"
ZF2463412	3/4" x 1/2"
ZF246112	1" x 1/2"
ZF246134	1" x 3/4"
ZF2465412	5/4" x 1/2"
ZF2465434	5/4" x 3/4"
ZF246541	5/4" x 1"
ZF2466434	6/4" x 3/4"
ZF246641	6/4" x 1"
ZF2466454	6/4" x 5/4"
ZF24621	2" x 1"
ZF246254	2" x 5/4"
ZF246264	2" x 6/4"
ZF246252	2 1/2" x 2"
ZF24632	3" x 2"
ZF246325	3" x 2 1/2"

NR 270 - MOF

BINNENDRAAD RECHTS - RECHTS

Bestelnr	Maat
ZF27018	1/8"
ZF27014	1/4"
ZF27038	3/8"
ZF27012	1/2"
ZF27034	3/4"
ZF2701	1"
ZF27054	5/4"
ZF27064	6/4"
ZF2702	2"
ZF27025	2 1/2"
ZF2703	3"
ZF2704	4"

VERZINKTE BUIZEN & FITTINGEN

VERZINKTE DRAADFITTINGEN



NR 271 - MOF

BINNENDRAAD LINKS - RECHTS

Bestelnr	Maat
ZF27112	1/2"
ZF27134	3/4"
ZF27111	1"
ZF27154	5/4"
ZF27164	6/4"
ZF2712	2"
ZF27125	2 1/2"



NR 280 - DUBBELE NIPPEL

2X BUITENDRAAD

Bestelnr	Maat
ZF28018	1/8"
ZF28014	1/4"
ZF28038	3/8"
ZF28012	1/2"
ZF28034	3/4"
ZF2801	1"
ZF28054	5/4"
ZF28064	6/4"
ZF2802	2"
ZF28025	2 1/2"
ZF2803	3"
ZF2804	4"

VERZINKTE BUIZEN & FITTINGEN

VERZINKTE BUIZEN & FITTINGEN

VERZINKTE DRAADFITTINGEN



NR 290 - PLUG

BUITENDRAAD

Bestelnr	Maat
ZF29018	1/8"
ZF29014	1/4"
ZF29038	3/8"
ZF29012	1/2"
ZF29034	3/4"
ZF2901	1"
ZF29054	5/4"
ZF29064	6/4"
ZF2902	2"
ZF29025	2 1/2"
ZF2903	3"
ZF2904	4"

NR 300 - DOP

BINNENDRAAD

Bestelnr	Maat
ZF30018	1/8"
ZF30014	1/4"
ZF30038	3/8"
ZF30012	1/2"
ZF30034	3/4"
ZF3001	1"
ZF30054	5/4"
ZF30064	6/4"
ZF3002	2"
ZF30025	2 1/2"
ZF3003	3"
ZF3004	4"

VERZINKTE BUIZEN & FITTINGEN

VERZINKTE DRAADFITTINGEN



NR 312 - TEGENMOER

BINNENDRAAD

Bestelnr	Maat
ZF31214	1/4"
ZF31238	3/8"
ZF31212	1/2"
ZF31234	3/4"
ZF3121	1"
ZF31254	5/4"
ZF31264	6/4"
ZF3122	2"
ZF31225	2 1/2"



NR 321 - RONDE FLENS

BINNENDRAAD

Bestelnr	Maat
ZF32134	3/4"
ZF3211	1"
ZF32154	5/4"
ZF32164	6/4"
ZF3212	2"



NR 326 - OVALE FLENS

BINNENDRAAD

Bestelnr	Maat
ZF32634	3/4"
ZF3261	1"
ZF32654	5/4"
ZF32664	6/4"

VERZINKTE BUIZEN & FITTINGEN

VERZINKTE DRAADFITTINGEN



NR 340 - RACCORD

2X BINNENDRAAD

Bestelnr	Maat
ZF34018	1/8"
ZF34014	1/4"
ZF34038	3/8"
ZF34012	1/2"
ZF34034	3/4"
ZF3401	1"
ZF34054	5/4"
ZF34064	6/4"
ZF3402	2"
ZF34025	2 1/2"
ZF3403	3"
ZF3404	4"

NR 341 - RACCORD

BINNENDRAAD - BUITENDRAAD

Bestelnr	Maat
ZF34114	1/4"
ZF34138	3/8"
ZF34112	1/2"
ZF34134	3/4"
ZF3411	1"
ZF34154	5/4"
ZF34164	6/4"
ZF3412	2"
ZF34125	2 1/2"
ZF3413	3"
ZF3414	4"
ZF3404	4"

VERZINKTE BUIZEN & FITTINGEN

VERZINKTE DRAADFITTINGEN



VERZINKTE BUIZEN & FITTINGEN

NR 344 - RACCORD

2X BUITENDRAAD

Bestelnr	Maat
ZF34412	1/2"
ZF3441	1"
ZF34464	6/4"

NR 471 - MUURKNIE

2X BINNENDRAAD

Bestelnr	Maat
ZF47112	1/2"
ZF47134	3/4"
ZF4711	1"

VERZINKTE BUIZEN & FITTINGEN

VERZINKTE DRAADFITTINGEN



VERZINKTE BUIZEN & FITTINGEN

NR 529A - VERLENGSTUK

BINNENDRAAD - BUITENDRAAD

Bestelnr	Maat
ZF529A14	1/4"
ZF529A38	3/8"
ZF529A12	1/2"
ZF529A34	3/4"
ZF529A1	1"
ZF529A54	5/4"
ZF529A64	6/4"
ZF529A2	2"

VERZINKTE BUIZEN & FITTINGEN

VERZINKTE PIJPNIPPELS

VERZINKTE BUIZEN & FITTINGEN



NR 23 - BUILENGSEL

BUITENDRAAD

Bestelnr	Maat	Maat
BUL140060	1/4"	60 mm
BUL140080	1/4"	80 mm
BUL140100	1/4"	100 mm
BUL140200	1/4"	200 mm
BUL380040	3/8"	40 mm
BUL380050	3/8"	50 mm
BUL380060	3/8"	60 mm
BUL380080	3/8"	80 mm
BUL380100	3/8"	100 mm
BUL380120	3/8"	120 mm
BUL380150	3/8"	150 mm
BUL380180	3/8"	180 mm
BUL380200	3/8"	200 mm
BUL380250	3/8"	250 mm
BUL380300	3/8"	300 mm
BUL120040	1/2"	40 mm
BUL120050	1/2"	50 mm
BUL120060	1/2"	60 mm
BUL120070	1/2"	70 mm
BUL120080	1/2"	80 mm
BUL120090	1/2"	90 mm
BUL120100	1/2"	100 mm
BUL120120	1/2"	120 mm
BUL120150	1/2"	150 mm
BUL120180	1/2"	180 mm
BUL120200	1/2"	200 mm
BUL120250	1/2"	250 mm
BUL120300	1/2"	300 mm
BUL120350	1/2"	350 mm
BUL120400	1/2"	400 mm
BUL120500	1/2"	500 mm

NR 23 - BUILENGSEL

BUITENDRAAD

Bestelnr	Maat	Maat
BUL340030	3/4"	30 mm
BUL340040	3/4"	40 mm
BUL340050	3/4"	50 mm
BUL340060	3/4"	60 mm
BUL340070	3/4"	70 mm
BUL340080	3/4"	80 mm
BUL340090	3/4"	90 mm
BUL340100	3/4"	100 mm
BUL340120	3/4"	120 mm
BUL340150	3/4"	150 mm
BUL340180	3/4"	180 mm
BUL340200	3/4"	200 mm
BUL340250	3/4"	250 mm
BUL340300	3/4"	300 mm
BUL340400	3/4"	400 mm
BUL340500	3/4"	500 mm
BUL341000	3/4"	1000 mm
BUL10040	1"	40 mm
BUL10050	1"	50 mm
BUL10060	1"	60 mm
BUL10070	1"	70 mm
BUL10080	1"	80 mm
BUL10090	1"	90 mm
BUL10100	1"	100 mm
BUL10120	1"	120 mm
BUL10150	1"	150 mm
BUL10180	1"	180 mm
BUL10200	1"	200 mm
BUL10250	1"	250 mm
BUL10300	1"	300 mm
BUL10500	1"	500 mm

VERZINKTE BUIZEN & FITTINGEN

VERZINKTE PIJPNIPPELS

VERZINKTE BUIZEN & FITTINGEN



NR 23 - BUISLENGSEL

BUITENDRAAD

Bestelnr	Maat	Maat
BUL10040	1"	400 mm
BUL10050	1"	500 mm
BUL540040	5/4"	40 mm
BUL540050	5/4"	50 mm
BUL540060	5/4"	60 mm
BUL540080	5/4"	80 mm
BUL540100	5/4"	100 mm
BUL540120	5/4"	120 mm
BUL540150	5/4"	150 mm
BUL540180	5/4"	180 mm
BUL540200	5/4"	200 mm
BUL540250	5/4"	250 mm
BUL540300	5/4"	300 mm
BUL640060	6/4"	60 mm
BUL640080	6/4"	80 mm
BUL640100	6/4"	100 mm
BUL640120	6/4"	120 mm
BUL640150	6/4"	150 mm
BUL640200	6/4"	200 mm
BUL640250	6/4"	250 mm
BUL640300	6/4"	300 mm
BUL20060	2"	60 mm
BUL20080	2"	80 mm
BUL20100	2"	100 mm
BUL20120	2"	120 mm

NR 23 - BUISLENGSEL

BUITENDRAAD

Bestelnr	Maat	Maat
BUL20150	2"	150 mm
BUL20180	2"	180 mm
BUL20200	2"	200 mm
BUL20250	2"	250 mm
BUL20300	2"	300 mm
BUL20500	2"	500 mm
BUL250100	2 1/2"	100 mm
BUL250150	2 1/2"	150 mm
BUL250200	2 1/2"	200 mm
BUL250250	2 1/2"	250 mm
BUL250300	2 1/2"	300 mm
BUL30100	3"	100 mm
BUL30150	3"	150 mm
BUL30200	3"	200 mm
BUL30250	3"	250 mm
BUL30300	3"	300 mm
BUL40100	4"	100 mm
BUL40150	4"	150 mm
BUL40200	4"	200 mm
BUL40250	4"	250 mm
BUL40300	4"	300 mm
BUL40400	4"	400 mm



VERZINKTE DRAADFLENS

BINNENDRAAD

Bestelnr	Maten	Flens PN	Lengte
ZFGF12	DN15 x 1/2"	10/16	65 mm
ZFGF34	DN20 x 3/4"	10/16	75 mm
ZFGF1	DN25 x 1"	10/16	85 mm
ZFGF54	DN32 x 5/4"	10/16	100 mm
ZFGF64	DN40 x 6/4"	10/16	110 mm
ZFGF2	DN50 x 2"	10/16	125 mm
ZFGF25	DN65 x 2 1/2"	10/16	145 mm
ZFGF3	DN80 x 3"	10/16	160 mm
ZFGF4	DN100 x 4"	10/16	180 mm
ZFGF5	DN125 x 5"	10/16	210 mm
ZFGF6	DN150 x 6"	10/16	240 mm



Meer info over flensafmetingen? Zie p106.

VERZINKTE BUIZEN & FITTINGEN

RUBBER COMPENSATOREN

VERZINKTE BUIZEN & FITTINGEN



RUBBER COMPENSATOR

EPDM

Bestelnr	Maat DN	Maat inch	Flens	Steekcirkel	Werkdruk
RCE032	DN32	5/4"	PN10	100 mm	16 bar
RCE040	DN40	6/4"	PN10	110 mm	16 bar
RCE050	DN50	2"	PN10	125 mm	16 bar
RCE065	DN65	2 1/2"	PN10	145 mm	16 bar
RCE080	DN80	3"	PN10	160 mm	16 bar
RCE100	DN100	4"	PN10	180 mm	16 bar
RCE125	DN125	5"	PN10	210 mm	16 bar
RCE150	DN150	6"	PN10	240 mm	16 bar
RCE200	DN200	8"	PN10	295 mm	10 bar
RCE250	DN250	10"	PN10	350 mm	10 bar
RCE300	DN300	12"	PN10	400 mm	10 bar
RCE350	DN350	14"	PN10	460 mm	8 bar
RCE400	DN400	16"	PN10	515 mm	8 bar
RCE450	DN450	18"	PN10	565 mm	8 bar
RCE500	DN500	20"	PN10	620 mm	8 bar
RCE600	DN600	24"	PN10	725 mm	8 bar

RUBBER COMPENSATOR

NBR

Bestelnr	Maat DN	Maat inch	Flens	Steekcirkel	Werkdruk
RCN032	DN32	5/4"	PN10	100 mm	16 bar
RCN040	DN40	6/4"	PN10	110 mm	16 bar
RCN050	DN50	2"	PN10	125 mm	16 bar
RCN065	DN65	2 1/2"	PN10	145 mm	16 bar
RCN080	DN80	3"	PN10	160 mm	16 bar
RCN100	DN100	4"	PN10	180 mm	16 bar
RCN125	DN125	5"	PN10	210 mm	16 bar
RCN150	DN150	6"	PN10	240 mm	16 bar
RCN200	DN200	8"	PN10	295 mm	10 bar
RCN250	DN250	10"	PN10	350 mm	10 bar
RCN300	DN300	12"	PN10	400 mm	10 bar
RCN350	DN350	14"	PN10	460 mm	8 bar
RCN400	DN400	16"	PN10	515 mm	8 bar
RCN450	DN450	18"	PN10	565 mm	8 bar
RCN500	DN500	20"	PN10	620 mm	8 bar
RCN600	DN600	24"	PN10	725 mm	8 bar



Meer info over flensafmetingen? Zie p106.

— DEEL 2 —

ZWARTE DRAAD- & LASFITTINGEN

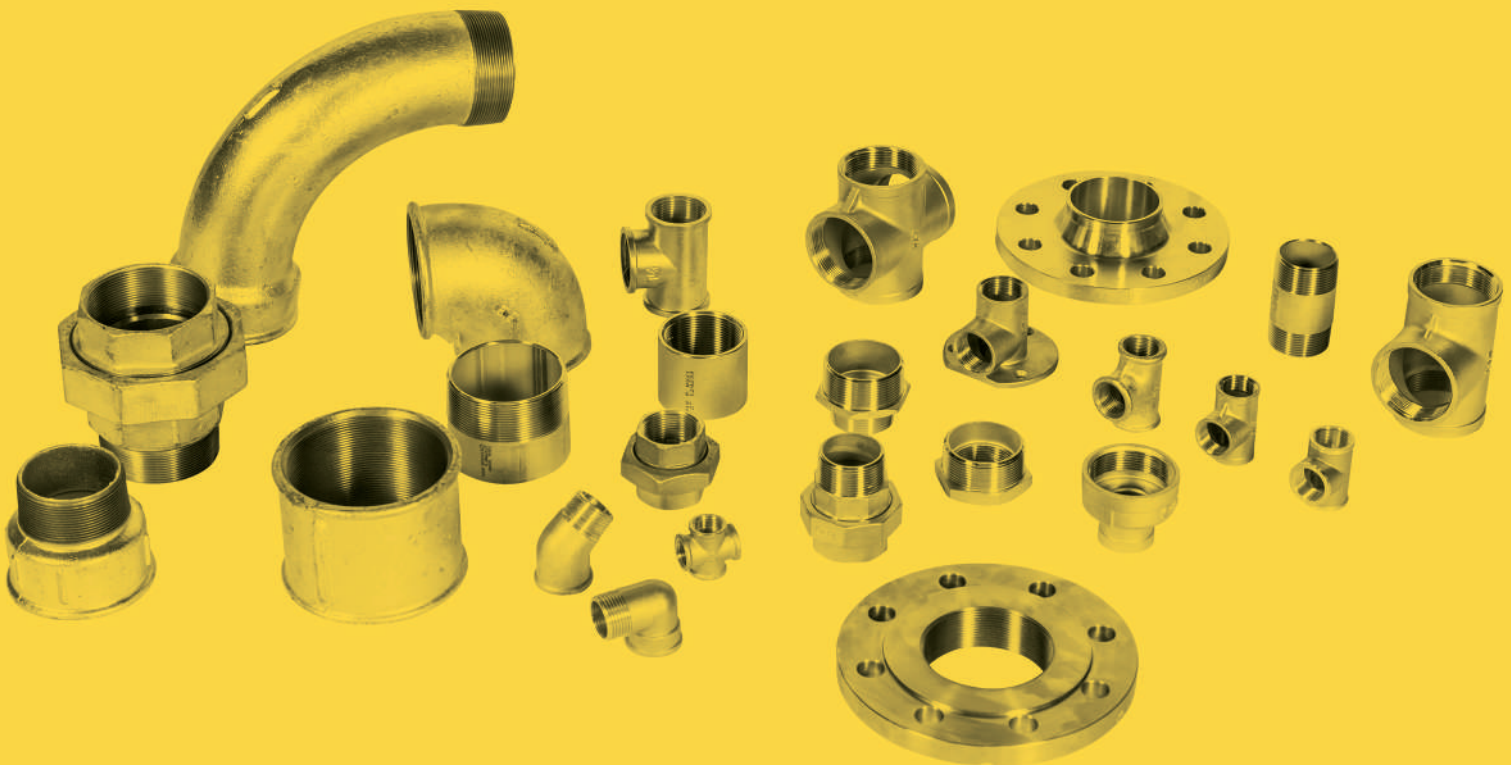

ZWARTE DRAAD- & LASFITTINGEN

— MALLEABEL —

Stalen buizen	40
Zwarte draadfittingen	41
Zwarte pijpnippels	50
Zwarte lasfittingen	52
Zwarte lastules	57
Stalen flenzen	58

ZWARTE DRAAD- & LASFITTINGEN

STALEN BUIZEN



STALEN GASBUIS

GLAD

Bestelnr	Maat	Wanddikte	Lengte
7GB1	1"	3,25 mm	6 m
7GB2	2"	3,65 mm	6 m
7GB4	4"	4,50 mm	6 m
7GB54	5/4"	3,25 mm	6 m
7GB64	6/4"	3,25 mm	6 m

NR 1 - LANGE BOCHT 90°

BINNENDRAAD - BUITENDRAAD

Bestelnr	Maat
7ZF114	1/4"
7ZF138	3/8"
7ZF112	1/2"
7ZF134	3/4"
7ZF11	1"
7ZF154	5/4"
7ZF164	6/4"
7ZF12	2"
7ZF13	3"

ZWARTE DRAAD- & LASFITTINGEN

ZWARTE DRAADFITTINGEN



NR 2 - LANGE BOCHT 90°

2X BINNENDRAAD

Bestelnr	Maat
7ZF238	3/8"
7ZF212	1/2"
7ZF234	3/4"
7ZF21	1"
7ZF254	5/4"
7ZF264	6/4"
7ZF22	2"
7ZF23	3"



NR 40 - BOCHT 45°

BINNENDRAAD - BUITENDRAAD

Bestelnr	Maat
7ZF4064	6/4"
7ZF402	2"
7ZF4025	2 1/2"

ZWARTE DRAAD- & LASFITTINGEN

ZWARTE DRAAD- & LASFITTINGEN

ZWARTE DRAADFITTINGEN



NR 90 - KNIE 90°

2X BINNENDRAAD

Bestelnr	Maat
7ZF9012	1/2"
7ZF9034	3/4"
7ZF901	1"
7ZF9054	5/4"
7ZF9064	6/4"
7ZF902	2"
7ZF9025	2 1/2"
7ZF903	3"
7ZF904	4"



NR 90R - REDUCTIEKNIE 90°

2X BINNENDRAAD

Bestelnr	Maat
7ZF90R1238	1/2" x 3/8"
7ZF90R3412	3/4" x 1/2"
7ZF90R112	1" x 1/2"
7ZF90R134	1" x 3/4"
7ZF90R5412	5/4" x 1/2"
7ZF90R5434	5/4" x 3/4"
7ZF90R541	5/4" x 1"
7ZF90R6434	6/4" x 3/4"
7ZF90R641	6/4" x 1"
7ZF90R6454	6/4" x 5/4"
7ZF90R21	2" x 1"
7ZF90R254	2" x 5/4"
7ZF90R264	2" x 6/4"

ZWARTE DRAAD- & LASFITTINGEN

ZWARTE DRAADFITTINGEN



NR 92 - KNIE 90°

BINNENDRAAD - BUITENDRAAD

Bestelnr	Maat
7ZF9218	1/8"
7ZF9214	1/4"
7ZF9238	3/8"
7ZF9212	1/2"
7ZF9234	3/4"
7ZF921	1"
7ZF9254	5/4"
7ZF9264	6/4"
7ZF922	2"
7ZF9225	2 1/2"
7ZF923	3"
7ZF924	4"



NR 96 - KNIKOPPELING

2X BINNENDRAAD

Bestelnr	Maat
7ZF9614	1/4"
7ZF9638	3/8"
7ZF9612	1/2"
7ZF9634	3/4"
7ZF961	1"
7ZF9654	5/4"
7ZF9664	6/4"
7ZF962	2"
7ZF9625	2 1/2"
7ZF963	3"

ZWARTE DRAAD- & LASFITTINGEN

ZWARTE DRAAD- & LASFITTINGEN

ZWARTE DRAADFITTINGEN



NR 98 - KNIKOPPELING 90°

BINNENDRAAD - BUITENDRAAD

Bestelnr	Maat
7ZF9814	1/4"
7ZF9838	3/8"
7ZF9812	1/2"
7ZF9834	3/4"
7ZF981	1"
7ZF9854	5/4"
7ZF9864	6/4"
7ZF982	2"
7ZF9825	2 1/2"



NR 120 - KNIK 45°

2X BINNENDRAAD

Bestelnr	Maat
7ZF12038	3/8"
7ZF12012	1/2"
7ZF12034	3/4"
7ZF1201	1"
7ZF12054	5/4"
7ZF12064	6/4"
7ZF1202	2"



NR 121 - KNIK 45°

BINNENDRAAD - BUITENDRAAD

Bestelnr	Maat
7ZF12138	3/8"
7ZF12112	1/2"
7ZF12134	3/4"
7ZF1211	1"
7ZF12154	5/4"
7ZF12164	6/4"
7ZF1212	2"

ZWARTE DRAAD- & LASFITTINGEN

ZWARTE DRAADFITTINGEN



NR 130 - T-STUK 90°

3X BINNENDRAAD

Bestelnr	Maat
7ZF13018	1/8"
7ZF13014	1/4"
7ZF13012	1/2"
7ZF13034	3/4"
7ZF1301	1"
7ZF13054	5/4"
7ZF13064	6/4"
7ZF1302	2"
7ZF13025	2 1/2"
7ZF1303	3"
7ZF1304	4"



NR 130R - VERLOOP T-STUK 90°

3X BINNENDRAAD

Bestelnr	Maat
7ZF1303812	3/8" x 1/2" x 3/8"
7ZF1301238	1/2" x 3/8" x 1/2"
7ZF1303438	3/4" x 3/8" x 3/4"
7ZF1303412	3/4" x 1/2" x 3/4"
7ZF130138	1" x 3/8" x 1"
7ZF130112	1" x 1/2" x 1"
7ZF130134	1" x 3/4" x 1"
7ZF1305412	5/4" x 1/2" x 5/4"
7ZF1305434	5/4" x 3/4" x 5/4"
7ZF130541	5/4" x 1" x 5/4"
7ZF1306412	6/4" x 1/2" x 6/4"
7ZF1306434	6/4" x 3/4" x 6/4"
7ZF130641	6/4" x 1" x 6/4"
7ZF1306454	6/4" x 5/4" x 6/4"
7ZF130212	2" x 1/2" x 2"
7ZF130234	2" x 3/4" x 2"
7ZF13021	2" x 1" x 2"
7ZF130254	2" x 5/4" x 2"
7ZF130264	2" x 6/4" x 2"
7ZF130252	2 1/2" x 2 x 2 1/2"

ZWARTE DRAAD- & LASFITTINGEN

ZWARTE DRAAD- & LASFITTINGEN

ZWARTE DRAADFITTINGEN



NR 240 - VERLOOPMOF

2X BINNENDRAAD

Bestelnr	Maat
7ZF2403818	3/8" x 1/8"
7ZF2403814	3/8" x 1/4"
7ZF2401214	1/2" x 1/4"
7ZF2401238	1/2" x 3/8"
7ZF2403414	3/4" x 1/4"
7ZF2403438	3/4" x 3/8"
7ZF2403412	3/4" x 1/2"
7ZF240138	1" x 3/8"
7ZF240112	1" x 1/2"
7ZF240134	1" x 3/4"
7ZF2405412	5/4" x 1/2"
7ZF2405434	5/4" x 3/4"
7ZF240541	5/4" x 1"
7ZF2406412	6/4" x 1/2"
7ZF2406434	6/4" x 3/4"
7ZF240641	6/4" x 1"
7ZF2406454	6/4" x 5/4"



NR 241 - VERLOOPRING

BUITENDRAAD - BINNENDRAAD

Bestelnr	Maat
7ZF2413412	3/4" x 1/2"
7ZF241112	1" x 1/2"
7ZF241134	1" x 3/4"
7ZF2415412	5/4" x 1/2"
7ZF2415434	5/4" x 3/4"
7ZF241541	5/4" x 1"
7ZF2416412	6/4" x 1/2"
7ZF2416434	6/4" x 3/4"
7ZF241641	6/4" x 1"
7ZF2416454	6/4" x 5/4"
7ZF241212	2" x 1/2"

ZWARTE DRAAD- & LASFITTINGEN

ZWARTE DRAADFITTINGEN



NR 245 - VERLOOPNIPPEL

2X BUITENDRAAD

Bestelnr	Maat
7ZF2453412	3/4" x 1/2"
7ZF245112	1" x 1/2"
7ZF245134	1" x 3/4"
7ZF245541	5/4" x 1"
7ZF2456412	6/4" x 1/2"
7ZF245641	6/4" x 1"
7ZF2456454	6/4" x 5/4"
7ZF2455412	5/4" x 1/2"
7ZF2455434	5/4" x 3/4"
7ZF2456434	6/4" x 3/4"



NR 270 - MOF

2X BINNENDRAAD

Bestelnr	Maat
7ZF27012	1/2"
7ZF27034	3/4"
7ZF2701	1"
7ZF27054	5/4"
7ZF27064	6/4"
7ZF2702	2"

ZWARTE DRAAD- & LASFITTINGEN



NR 280 - DUBBELE NIPPEL

2X BUITENDRAAD

Bestelnr	Maat
7ZF28012	1/2"
7ZF28034	3/4"
7ZF2801	1"
7ZF28054	5/4"
7ZF28064	6/4"
7ZF2802	2"
7ZF28025	2 1/2"

ZWARTE DRAAD- & LASFITTINGEN

ZWARTE DRAADFITTINGEN



NR 290 - PLUG

BUITENDRAAD

Bestelnr	Maat
7ZF29018	1/8"
7ZF29014	1/4"
7ZF29038	3/8"
7ZF29012	1/2"
7ZF29034	3/4"
7ZF2901	1"
7ZF29054	5/4"
7ZF29064	6/4"
7ZF2902	2"
7ZF29025	2 1/2"
7ZF2903	3"
7ZF2904	4"



NR 300 - DOP

BINNENDRAAD

Bestelnr	Maat
7ZF30018	1/8"
7ZF30014	1/4"
7ZF30038	3/8"
7ZF30012	1/2"
7ZF30034	3/4"
7ZF3001	1"
7ZF30054	5/4"
7ZF30064	6/4"
7ZF3002	2"
7ZF30025	2 1/2"
7ZF3003	3"
7ZF3004	4"

ZWARTE DRAAD- & LASFITTINGEN

ZWARTE DRAADFITTINGEN



NR 340 - RACCORD

2X BINNENDRAAD

Bestelnr	Maat
7ZF34012	1/2"
7ZF34034	3/4"
7ZF3401	1"
7ZF34054	5/4"
7ZF34064	6/4"
7ZF3402	2"
7ZF34025	2 1/2"



NR 341 - RACCORD

BINNENDRAAD - BUITENDRAAD

Bestelnr	Maat
7ZF34112	1/2"
7ZF34134	3/4"
7ZF3411	1"
7ZF34154	5/4"
7ZF34164	6/4"
7ZF3412	2"
7ZF34125	2 1/2"

ZWARTE DRAAD- & LASFITTINGEN

ZWARTE DRAAD- & LASFITTINGEN

ZWARTE PIJPNIPPELS



NR 23 - BUISLENGSEL

BUITENDRAAD

Bestelnr	Maten	Lengte
7BUL140120	1/4"	120 mm
7BUL140150	1/4"	150 mm
7BUL380040	3/8"	40 mm
7BUL380050	3/8"	50 mm
7BUL380060	3/8"	60 mm
7BUL380080	3/8"	80 mm
7BUL380120	3/8"	120 mm
7BUL380150	3/8"	150 mm
7BUL380180	3/8"	180 mm
7BUL380200	3/8"	200 mm
7BUL120040	1/2"	40 mm
7BUL120050	1/2"	50 mm
7BUL120060	1/2"	60 mm
7BUL120080	1/2"	80 mm
7BUL120100	1/2"	100 mm
7BUL120120	1/2"	120 mm
7BUL120150	1/2"	150 mm
7BUL120180	1/2"	180 mm
7BUL120200	1/2"	200 mm
7BUL120300	1/2"	300 mm
7BUL340080	3/4"	80 mm
7BUL340100	3/4"	100 mm
7BUL340150	3/4"	150 mm
7BUL340180	3/4"	180 mm
7BUL340200	3/4"	200 mm
7BUL340250	3/4"	250 mm



NR 23 - BUISLENGSEL

BUITENDRAAD

Bestelnr	Maten	Lengte
7BUL10040	1"	40 mm
7BUL10080	1"	80 mm
7BUL10100	1"	100 mm
7BUL10120	1"	120 mm
7BUL10150	1"	150 mm
7BUL10180	1"	180 mm
7BUL10200	1"	200 mm
7BUL10300	1"	300 mm
7BUL540060	5/4"	60 mm
7BUL540080	5/4"	80 mm
7BUL540100	5/4"	100 mm
7BUL540120	5/4"	120 mm
7BUL540150	5/4"	150 mm
7BUL540180	5/4"	180 mm
7BUL540200	5/4"	200 mm
7BUL540250	5/4"	250 mm
7BUL640060	6/4"	60 mm
7BUL640080	6/4"	80 mm
7BUL640100	6/4"	100 mm
7BUL640120	6/4"	120 mm
7BUL640150	6/4"	150 mm
7BUL640180	6/4"	180 mm
7BUL640200	6/4"	200 mm
7BUL640250	6/4"	250 mm
7BUL640300	6/4"	300 mm



NR 23 - BUISLENGSEL

BUITENDRAAD

Bestelnr	Maten	Lengte
7BUL20080	2"	80 mm
7BUL20150	2"	150 mm
7BUL20180	2"	180 mm
7BUL20200	2"	200 mm
7BUL20250	2"	250 mm
7BUL250100	2 1/2"	100 mm
7BUL250150	2 1/2"	150 mm
7BUL250200	2 1/2"	200 mm
7BUL250250	2 1/2"	250 mm
7BUL250300	2 1/2"	300 mm
7BUL30150	3"	150 mm
7BUL30200	3"	200 mm
7BUL30250	3"	250 mm
7BUL30300	3"	300 mm
7BUL40200	4"	200 mm
7BUL40250	4"	250 mm
7BUL40300	4"	300 mm
7BUL40400	4"	400 mm

ZWARTE DRAAD- & LASFITTINGEN

ZWARTE LASFITTINGEN



5D LASBOCHT 90°

STAAL

Bestelnr	Maten	Wanddikte
LAB021390	21,3 mm	2,0 mm
LAB026990	26,9 mm	2,3 mm
LAB033790	33,7 mm	2,6 mm
LAB042490	42,4 mm	2,6 mm
LAB048390	48,3 mm	2,6 mm
LAB051090	51 mm	2,6 mm
LAB060390	60,3 mm	2,9 mm
LAB076190	76,1 mm	2,9 mm
LAB088990	88,9 mm	3,2 mm
LAB101690	101,6 mm	3,6 mm
LAB108090	108,0 mm	3,6 mm
LAB114390	114,3 mm	3,6 mm
LAB120090	120 mm	3,6 mm
LAB133090	133,0 mm	4,0 mm
LAB139790	139,7 mm	4,0 mm
LAB159090	159,0 mm	4,5 mm
LAB168690	168,3 mm	4,5 mm
LAB193790	193,7 mm	5,6 mm
LAB200090	200 mm	2 mm
LAB219590	219,5 mm	6,3 mm

3D LASBOCHT 90°

STAAL

Bestelnr	Maten	Wanddikte
LAK021390	21,3 mm	2,0 mm
LAK026990	26,9 mm	2,3 mm
LAK031890	31,8 mm	2,6 mm
LAK033790	33,7 mm	2,6 mm
LAK038090	38 mm	2,6 mm
LAK042490	42,4 mm	2,6 mm
LAK048390	48,3 mm	2,6 mm
LAK051090	51 mm	2,6 mm
LAK057090	57 mm	2,6 mm
LAK060390	60,3 mm	2,9 mm
LAK063590	63,5 mm	2,9 mm
LAK070090	70 mm	2,9 mm
LAK076190	76,1 mm	3,2 mm
LAK082590	82,5 mm	3,2 mm
LAK088990	88,9 mm	3,2 mm
LAK101690	101,6 mm	3,6 mm
LAK108090	108,0 mm	3,6 mm
LAK114390	114,3 mm	3,6 mm
LAK133090	133,0 mm	4,0 mm
LAK139790	139,7 mm	4,0 mm
LAK159090	159,0 mm	4,5 mm
LAK168390	168,3 mm	4,5 mm
LAK193790	193,7 mm	5,6 mm
LAK219190	219,1 mm	6,3 mm
LAK273090	273,0 mm	6,3 mm
LAK323990	323,9 mm	7,1 mm
LAK355690	355,6 mm	8,0 mm
LAK406490	406,4 mm	8,8 mm
LAK508090	508,0 mm	11,0 mm



LAS T-STUK 90°

STAAL

Bestelnr	Maten	Wanddikte
LAT0213	21,3 mm	2 mm
LAT0269	26,9 mm	2,3 mm
LAT0337	33,7 mm	2,6 mm
LAT0424	42,4 mm	2,6 mm
LAT0480	48 mm	2,6 mm
LAT0570	57 mm	2,9 mm
LAT0603	60,3 mm	2,9 mm
LAT0761	76,1 mm	2,9 mm
LAT0889	88,9 mm	3,2 mm
LAT1080	108 mm	3,6 mm
LAT1143	114,3 mm	3,6 mm
LAT1397	139,7 mm	4 mm
LAT1590	159 mm	4,5 mm
LAT1683	168,3 mm	4,5 mm
LAT2191	219,1 mm	6,3 mm
LAT2730	273,0 mm	6,3 mm
LAT3239	323,9 mm	7,1 mm

ZWARTE DRAAD- & LASFITTINGEN

ZWARTE LASFITTINGEN



LASVERLOOPSTUK CONCENTRISCH

STAAL

LASVERLOOPSTUK CONCENTRISCH

STAAL

Bestelnr	Maten	Wanddikte
LAR0260210	26,9 mm x 21,3 mm	2,3 mm x 2,0 mm
LAR0330210	33,7 mm x 21,6 mm	2,6 mm x 2,0 mm
LAR0330260	33,7 mm x 26,9 mm	2,6 mm x 2,3 mm
LAR0420210	42,4 mm x 21,3 mm	2,6 mm x 2,3 mm
LAR0420260	42,4 mm x 26,9 mm	2,6 mm x 2,3 mm
LAR0420330	42,4 mm x 33,7 mm	2,6 mm x 2,6 mm
LAR0480260	48,3 mm x 26,9 mm	2,6 mm x 2,3 mm
LAR0480330	48,3 mm x 33,7 mm	2,6 mm x 2,6 mm
LAR0480420	48,3 mm x 42,4 mm	2,6 mm x 2,6 mm
LAR0570330	57,0 mm x 33,7 mm	2,9 mm x 2,6 mm
LAR0600330	60,3 mm x 33,7 mm	2,9 mm x 2,6 mm
LAR0600420	60,3 mm x 42,4 mm	2,9 mm x 2,6 mm
LAR0600480	60,3 mm x 48,3 mm	2,9 mm x 2,6 mm
LAR0700330	70,0 mm x 33,7 mm	2,9 mm x 2,6 mm
LAR0700420	70,0 mm x 42,4 mm	2,9 mm x 2,6 mm
LAR0700480	70,0 mm x 48,3 mm	2,9 mm x 2,6 mm
LAR0700600	70,0 mm x 60,3 mm	2,9 mm x 2,9 mm
LAR0760330	76,1 mm x 33,7 mm	2,9 mm x 2,6 mm
LAR0760420	76,1 mm x 42,4 mm	2,9 mm x 2,6 mm
LAR0760480	76,1 mm x 48,3 mm	2,9 mm x 2,6 mm
LAR0760570	76,1 mm x 57,0 mm	2,9 mm x 2,9 mm
LAR0760600	76,1 mm x 60,3 mm	2,9 mm x 2,9 mm
LAR0880570	88,9 mm x 57,0 mm	3,2 mm x 2,9 mm
LAR0880420	88,9 mm x 42,4 mm	3,2 mm x 2,6 mm
LAR0880480	88,9 mm x 48,3 mm	3,2 mm x 2,6 mm
LAR0880600	88,9 mm x 60,3 mm	3,2 mm x 2,9 mm
LAR0880760	88,9 mm x 76,1 mm	3,2 mm x 2,9 mm
LAR1010600	101,6 mm x 60,3 mm	3,6 mm x 2,9 mm
LAR1010760	101,6 mm x 76,1 mm	3,6 mm x 2,9 mm
LAR1010880	101,6 mm x 88,9 mm	3,6 mm x 2,9 mm
LAR1010881	101,6 mm x 88,9 mm	3,6 mm x 3,2 mm
LAR1080600	108,0 mm x 60,3 mm	3,6 mm x 2,9 mm
LAR1080760	108,0 mm x 76,1 mm	3,6 mm x 2,9 mm
LAR1080880	108,0 mm x 88,9 mm	3,6 mm x 3,2 mm
LAR1140480	114,3 mm x 48,3 mm	3,6 mm x 2,6 mm
LAR1140600	114,3 mm x 60,3 mm	3,6 mm x 2,9 mm
LAR1140700	114,3 mm x 70,0 mm	3,6 mm x 2,9 mm
LAR1140760	114,3 mm x 76,1 mm	3,6 mm x 2,9 mm
LAR1140880	114,3 mm x 88,9 mm	3,6 mm x 3,2 mm

Bestelnr	Maten	Wanddikte
LAR1330600	133,0 mm x 60,3 mm	3,6 mm x 2,9 mm
LAR1330760	133,0 mm x 76,1 mm	4,0 mm x 2,9 mm
LAR1330880	133,0 mm x 88,9 mm	4,0 mm x 3,2 mm
LAR1331080	133,0 mm x 108,0 mm	4,0 mm x 3,6 mm
LAR1331140	133,0 mm x 114,3 mm	4,0 mm x 3,6 mm
LAR1390760	139,7 mm x 76,1 mm	4,0 mm x 2,9 mm
LAR1390890	139,7 mm x 88,9 mm	4,0 mm x 3,2 mm
LAR1391140	139,7 mm x 114,3 mm	4,0 mm x 3,6 mm
LAR1590600	159,0 mm x 60,3 mm	4,5 mm x 2,9 mm
LAR1590760	159,0 mm x 76,1 mm	4,5 mm x 2,9 mm
LAR1590880	159,0 mm x 88,9 mm	4,5 mm x 3,2 mm
LAR1591080	159,0 mm x 108,0 mm	4,5 mm x 3,6 mm
LAR1591140	159,0 mm x 114,3 mm	4,0 mm x 3,6 mm
LAR1591330	159,0 mm x 133,0 mm	4,0 mm x 4,0 mm
LAR1680880	168,3 mm x 88,9 mm	4,5 mm x 3,2 mm
LAR1681080	168,3 mm x 108,0 mm	4,5 mm x 3,6 mm
LAR1681140	168,3 mm x 114,3 mm	4,5 mm x 3,6 mm
LAR1681330	168,3 mm x 133,0 mm	4,5 mm x 4,0 mm
LAR1681390	168,3 mm x 139,7 mm	4,5 mm x 4,0 mm
LAR1931590	193,7 mm x 159,0 mm	5,0 mm x 4,5 mm
LAR2191140	219,1 mm x 114,3 mm	6,3 mm x 3,6 mm
LAR2191330	219,1 mm x 133,0 mm	6,3 mm x 3,6 mm
LAR2191400	219,1 mm x 139,7 mm	6,3 mm x 4,0 mm
LAR2191590	219,1 mm x 159,0 mm	6,3 mm x 4,5 mm
LAR2191680	219,1 mm x 168,3 mm	6,3 mm x 4,5 mm
LAR2731400	273,0 mm x 139,7 mm	6,3 mm x 4,0 mm
LAR2731680	273,0 mm x 168,3 mm	6,3 mm x 4,5 mm
LAR2732190	273,0 mm x 219,1 mm	6,3 mm x 6,3 mm
LAR3241680	323,9 mm x 168,3 mm	7,1 mm x 4,5 mm
LAR3242190	323,9 mm x 219,1 mm	7,1 mm x 6,3 mm
LAR3242730	323,9 mm x 273,0 mm	7,1 mm x 6,3 mm
LAR3562190	355,6 mm x 219,1 mm	8,0 mm x 6,3 mm
LAR3562730	355,6 mm x 273,0 mm	8,0 mm x 6,3 mm
LAR3563240	355,6 mm x 323,9 mm	8,0 mm x 7,1 mm
LAR4062730	406,4 mm x 273,0 mm	8,8 mm x 6,3 mm
LAR4063240	406,4 mm x 323,9 mm	8,8 mm x 7,1 mm

ZWARTE DRAAD- & LASFITTINGEN

ZWARTE LASFITTINGEN



BUISBODEM

STAAL

Bestelnr	Maten	Wanddikte
LAE0269	26,9 mm	3 mm
LAE0337	33,7 mm	3 mm
LAE0424	42,4 mm	3 mm
LAE0483	48,3 mm	3 mm
LAE0573	57,3 mm	3 mm
LAE0603	60,3 mm	3 mm
LAE0761	76,1 mm	3 mm
LAE0889	88,9 mm	3 mm
LEA1016	101,6 mm	4 mm
LAE1080	108,0 mm	4 mm
LAE1143	114,3 mm	4 mm
LAE1337	133,7 mm	4 mm
LAE1397	139,7 mm	4 mm
LAE1590	159,0 mm	5 mm
LAE1683	168,3 mm	5 mm
LAE1937	193,7 mm	6 mm
LAE2191	219,1 mm	6 mm
LAE2730	273,0 mm	6 mm
LAE3239	323,9 mm	6 mm
LAE4064	406,4 mm	8 mm

LASNIPPEL

STAAL

Bestelnr	Maten	Lengte
LAN14030	1/4"	30 mm
LAN38030	3/8"	30 mm
LAN12035	1/2"	35 mm
LAN34040	3/4"	40 mm
LAN1040	1"	40 mm
LAN54050	5/4"	50 mm
LAN64050	6/4"	50 mm
LAN2050	2"	50 mm
LAN25060	2 1/2"	60 mm
LAN3070	3"	70 mm
LAN4150	4"	150 mm
LAN5100	5"	100 mm
LAN5150	5"	150 mm
LAN6100	6"	100 mm
LAN6150	6"	150 mm

ZWARTE DRAAD- & LASFITTINGEN

ZWARTE DRAAD- & LASFITTINGEN

ZWARTE LASFITTINGEN



LASMOF

STAAL

Bestelnr	Maat
LAM14	1/4"
LAM38	3/8"
LAM12	1/2"
LAM34	3/4"
LAM1	1"
LAM54	5/4"
LAM64	6/4"
LAM2	2"
LAM25	2 1/2"
LAM3	3"
LAM4	4"



LASMOF HALF

STAAL

Bestelnr	Maat
LAMH14	1/4"
LAMH38	3/8"
LAMH12	1/2"
LAMH34	3/4"
LAMH1	1"
LAMH54	5/4"
LAMH64	6/4"
LAMH2	2"
LAMH25	2 1/2"
LAMH3	3"
LAMH4	4"

ZWARTE DRAAD- & LASFITTINGEN

ZWARTE LASTULES



LASTULE

STAAL

LASTULE GERIBD

STAAL

Bestelnr	Maat	Lengte
LAS050110	50 mm	110 mm
LAS050130	50 mm	130 mm
LAS063135	63 mm	135 mm
LAS070135	70 mm	135 mm
LAS070190	70 mm	190 mm
LAS075135	75 mm	135 mm
LAS075190	75 mm	190 mm
LAS080135	80 mm	135 mm
LAS080180	80 mm	180 mm
LAS090135	90 mm	135 mm
LAS090190	90 mm	190 mm
LAS100140	100 mm	140 mm
LAS100185	100 mm	185 mm
LAS100220	100 mm	220 mm
LAS108185	108 mm	185 mm
LAS108220	108 mm	220 mm
LAS120220	120 mm	220 mm
LAS125165	125 mm	165 mm
LAS125190	125 mm	190 mm
LAS125200	125 mm	200 mm
LAS125220	125 mm	220 mm
LAS150150	150 mm	150 mm
LAS150190	150 mm	190 mm
LAS150215	150 mm	215 mm
LAS150250	150 mm	250 mm
LAS200250	200 mm	250 mm
LAS250300	250 mm	300 mm

Bestelnr	Maat	Lengte	Wanddikte
LASR020070	20 mm	70 mm	2 mm
LASR025070	25 mm	70 mm	2 mm
LASR030070	30 mm	70 mm	2 mm
LASR035070	35 mm	70 mm	2 mm
LASR040070	40 mm	70 mm	2 mm
LASR045070	45 mm	70 mm	2 mm
LASR050070	50 mm	70 mm	2 mm
LASR060075	60 mm	75 mm	2 mm
LASR065075	65 mm	75 mm	2 mm
LASR070090	70 mm	90 mm	3 mm
LASR075115	75 mm	115 mm	3 mm
LASR080115	80 mm	115 mm	3 mm
LASR090120	90 mm	120 mm	3 mm
LASR100120	100 mm	120 mm	3 mm
LASR110120	110 mm	120 mm	3 mm
LASR120130	120 mm	130 mm	2 mm
LASR125130	125 mm	130 mm	3 mm
LASR140135	140 mm	135 mm	3 mm
LASR150140	150 mm	140 mm	3 mm
LASR200200	200 mm	200 mm	3 mm
LASR250250	250 mm	250 mm	3 mm
LASR300300	300 mm	300 mm	3 mm

ZWARTE DRAAD- & LASFITTINGEN

ZWARTE DRAAD- & LASFITTINGEN

STALEN FLENZEN



LASTULE GERIBD

STAAL

Bestelnr	Maat	Lengte	Wanddikte
LASR080105	80 mm	105 mm	2 mm
LASR080165	80 mm	165 mm	2 mm
LASR080185	80 mm	185 mm	2 mm
LASR090110	90 mm	110 mm	3 mm
LASR090165	90 mm	165 mm	3 mm
LASR090185	90 mm	185 mm	3 mm
LASR100110	100 mm	110 mm	3 mm
LASR100165	100 mm	165 mm	3 mm
LASR100200	100 mm	200 mm	3 mm
LASR110120	110 mm	120 mm	3 mm
LASR110165	110 mm	165 mm	3 mm
LASR112165	112 mm	165 mm	3 mm
LASR112200	112 mm	200 mm	3 mm
LASR120130	120 mm	130 mm	3 mm
LASR125130	125 mm	130 mm	3 mm
LASR125180	125 mm	180 mm	3 mm
LASR125220	125 mm	220 mm	3 mm
LASR150140	150 mm	140 mm	3 mm
LASR150180	150 mm	180 mm	3 mm
LASR150220	150 mm	220 mm	3 mm
LASR200200	200 mm	200 mm	3 mm

ZWARTE VOORLASFLENS

STAAL

Bestelnr	Maat DN	Flens PN	Steekcirkel
ZFVL015021316	DN15 x 21,3mm	10/16	65 mm
ZFVL020026916	DN20 x 26,9mm	10/16	75 mm
ZFVL025033716	DN25 x 33,7mm	10/16	85 mm
ZFVL032042416	DN32 x 42,4mm	10/16	100 mm
ZFVL040048316	DN40 x 48,3mm	10/16	110 mm
ZFVL050060316	DN50 x 60,3mm	10/16	125 mm
ZFVL065076116	DN65 x 76,1mm	10/16	145 mm
ZFVL080088916	DN80 x 88,9mm	10/16	160 mm
ZFVL100108016	DN100 x 108,0mm	10/16	180 mm
ZFVL100114316	DN100 x 114,3mm	10/16	180 mm
ZFVL125133016	DN125 x 133,0mm	10/16	210 mm
ZFVL125139716	DN125 x 139,7mm	10/16	210 mm
ZFVL150159016	DN150 x 159,0mm	10/16	240 mm
ZFVL151168316	DN150 x 168,3mm	10/16	240 mm
ZFVL200219116	DN200 x 219,1mm	10/16	295 mm
ZFVL250273010	DN250 x 273,0 mm	10	350 mm
ZFVL250273016	DN250 x 273,0mm	16	355 mm
ZFVL300323916	DN300 x 323,9mm	16	410 mm
ZFVL350355616	DN350 x 355,6mm	16	470 mm
ZFVL400406416	DN400 x 406,4mm	16	525 mm



ZWARTE VLAKKE FLENS

STAAL

Bestelnr	Maat DN	Flens PN	Steekcirkel
ZFVF025033716	DN25 x 33,7 mm	10/16	85 mm
ZFVF032424016	DN32 x 42,4 mm	10/16	100 mm
ZFVF040048316	DN40 x 48,3 mm	10/16	110 mm
ZFVF050060316	DN50 x 60,3 mm	10/16	125 mm
ZFVF065076116	DN65 x 76,1 mm	10/16	145 mm
ZFVF080088916	DN80 x 88,9 mm	10/16	160 mm
ZFVF100108016	DN100 x 108,0 mm	10/16	180 mm
ZFVF100114316	DN100 x 114,3 mm	10/16	180 mm
ZFVF125133016	DN125 x 133,0 mm	10/16	210 mm
ZFVF125139716	DN125 x 139,7 mm	10/16	210 mm
ZFVF150159016	DN150 x 159,0 mm	10/16	240 mm
ZFVF150168316	DN150 x 168,3 mm	10/16	240 mm
ZFVF200219110	DN200 x 219,1 mm	10	295 mm
ZFVF200219116	DN200 x 219,1 mm	16	295 mm
ZFVF250273016	DN250 x 273,0 mm	16	355 mm
ZFVF300323010	DN300 x 323,0 mm	10	400 mm
ZFVF300323016	DN300 x 323,0 mm	16	410 mm
ZFVF350355616	DN350 x 355,6 mm	16	470 mm
ZFVF400406416	DN400 x 406,4 mm	16	525 mm
ZFVF450457016	DN450 x 457,0 mm	16	585 mm



ZWARTE BLINDFLENS

STAAL

Bestelnr	Maat DN	Flens PN	Steekcirkel
ZFBF01516	DN15	16	65 mm
ZFBF02016	DN20	16	75 mm
ZFBF02516	DN25	16	85 mm
ZFBF03216	DN32	16	100 mm
ZFBF04016	DN40	16	110 mm
ZFBF05016	DN50	16	125 mm
ZFBF06516	DN65	16	145 mm
ZFBF08016	DN80	16	160 mm
ZFBF10016	DN100	16	180 mm
ZFBF12516	DN125	16	210 mm
ZFBF15016	DN150	16	240 mm
ZFBF20010	DN200	10	295 mm
ZFBF25010	DN250	10	350 mm
ZFBF30010	DN300	16	410 mm



Meer info over flensafmetingen? Zie p106.

NOTITIES

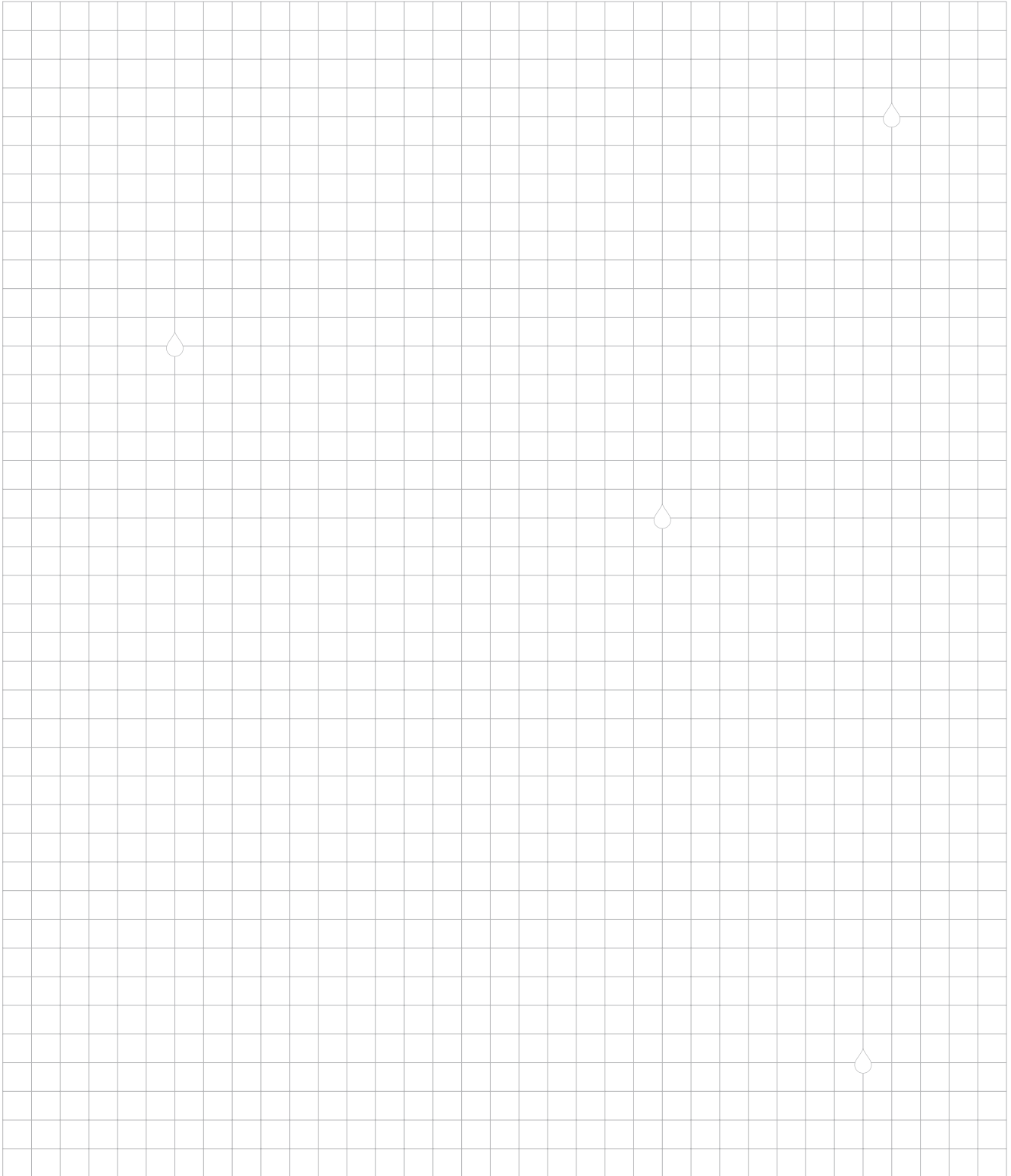

— DEEL 3 —

MESSING DRAADFITTINGEN

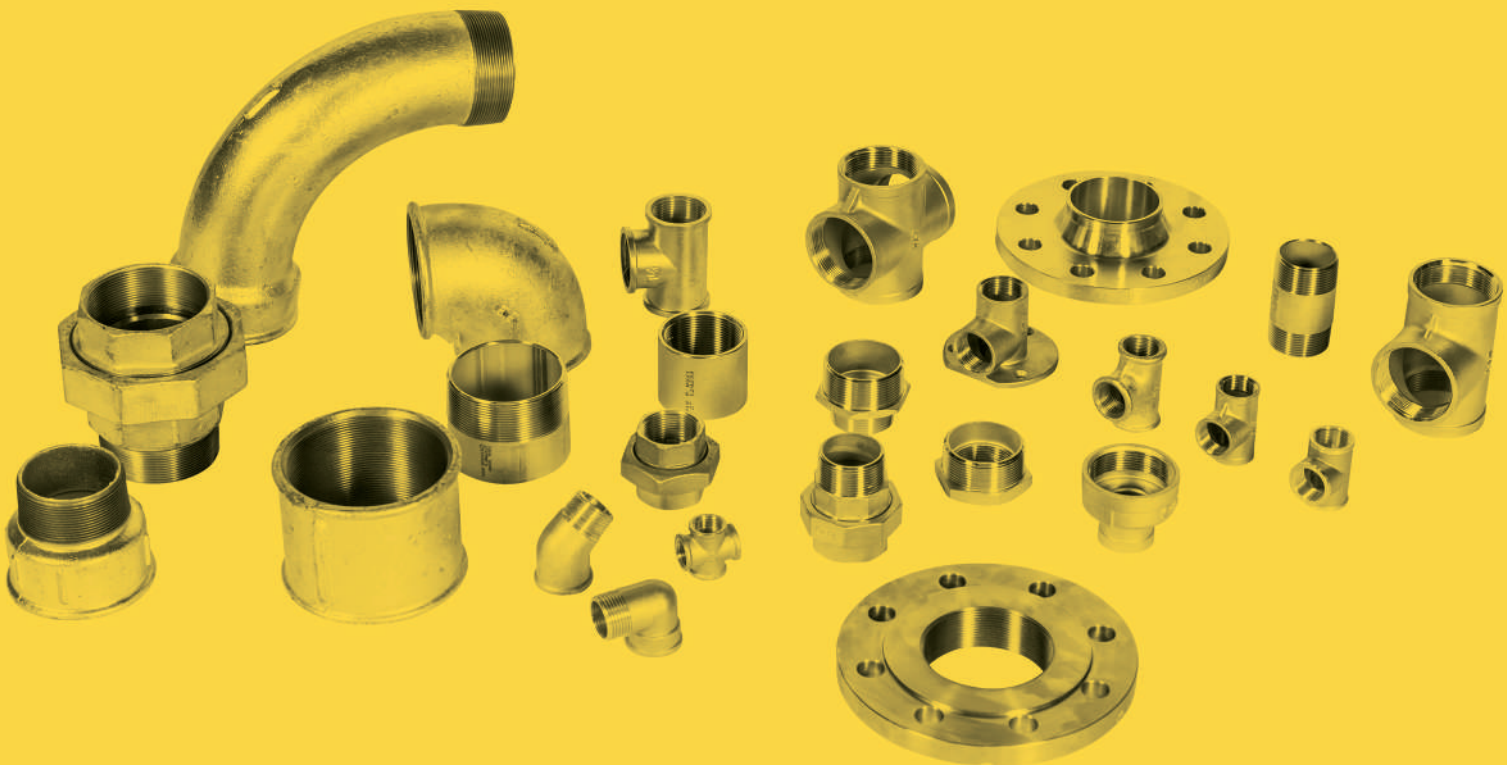



NR 1 - MESSING BOCHT 90°

BINNENDRAAD - BUITENDRAAD

Bestelnr	Maat
MF112	1/2"
MF134	3/4"
MF11	1"
MF154	5/4"
MF164	6/4"
MF12	2"



NR 2 - MESSING BOCHT 90°

2X BINNENDRAAD

Bestelnr	Maat
MF212	1/2"
MF234	3/4"
MF21	1"
MF254	5/4"
MF264	6/4"
MF22	2"

MESSING DRAADFITTINGEN



NR 90 - MESSING KNIE 90°

2X BINNENDRAAD

Bestelnr	Maat
MF9014	1/4"
MF9038	3/8"
MF9012	1/2"
MF9034	3/4"
MF901	1"
MF9054	5/4"
MF9064	6/4"
MF902	2"



NR 92 - MESSING KNIE 90°

BINNENDRAAD - BUITENDRAAD

Bestelnr	Maat
MF9214	1/4"
MF9238	3/8"
MF9212	1/2"
MF9234	3/4"
MF921	1"
MF9254	5/4"
MF9264	6/4"
MF922	2"

MESSING DRAADFITTINGEN



NR 94 - MESSING BOCHT 90°

2X BUITENDRAAD

Bestelnr	Maat
MF9412	1/2"



NR 96 - MESSING KNEIKOPPELING

2X BINNENDRAAD

Bestelnr	Maat
MF9612	1/2"
MF961	1"
MF9654	5/4"
MF9664	6/4"
MF962	2"



NR 98 - MESSING KNEIKOPPELING

BINNENDRAAD - BUITENDRAAD

Bestelnr	Maat
MF9834	3/4"
MF981	1"
MF9854	5/4"
MF9864	6/4"
MF982	2"

MESSING DRAADFITTINGEN



NR 110 - MESSING 2/3 KOPPELING

WARTEL BINNENDRAAD - BUITENDRAAD

Bestelnr	Maat
MF11012142	1/4" x 2"
MF1101238	1/2" x 3/8"
MF1103412	3/4" x 1/2"
MF110134	1" x 3/4"
MF110541	5/4" x 1"
MF1106454	6/4" x 5/4"
MF110264	2" x 6/4"



NR 120 - MESSING KNIE 45°

2X BINNENDRAAD

Bestelnr	Maat
MF12012	1/2"
MF12034	3/4"
MF1201	1"
MF12054	5/4"
MF12064	6/4"
MF1202	2"



NR 121 - MESSING KNIE 45°

BINNENDRAAD - BUITENDRAAD

Bestelnr	Maat
MF12112	1/2"
MF12134	3/4"
MF12111	1"
MF12154	5/4"
MF12164	6/4"
MF1212	2"



NR 130 - MESSING T-STUK 90°

3X BINNENDRAAD

Bestelnr	Maat
MF13018	1/8"
MF13014	1/4"
MF13038	3/8"
MF13012	1/2"
MF13034	3/4"
MF1301	1"
MF13054	5/4"
MF13064	6/4"

MESSING DRAADFITTINGEN



NR 130R - MESSING VERLOOP T-STUK 90°

3X BINNENDRAAD

Bestelnr	Maten
MF1303412	3/4" x 1/2" x 3/4"
MF130112	1" x 1/2" x 1"
MF1305434	5/4" x 3/4" x 5/4"
MF130541	5/4" x 1" x 5/4"



NR 180 - MESSING KRUISSTUK

4X BINNENDRAAD

Bestelnr	Maat
MF18038	3/8"
MF18012	1/2"
MF18034	3/4"
MF1801	1"
MF18054	5/4"
MF18064	6/4"
MF1802	2"

MESSING DRAADFITTINGEN



NR 230 - MESSING KRAANVERLENGSTUK

BINNENDRAAD - BUITENDRAAD

Bestelnr	Maat	Lengte
MF23012010	1/2"	10 mm
MF23012015	1/2"	15 mm
MF23012020	1/2"	20 mm
MF23012025	1/2"	25 mm
MF23012030	1/2"	30 mm
MF23012040	1/2"	40 mm
MF23012050	1/2"	50 mm
MF23012080	1/2"	80 mm
MF23012100	1/2"	100 mm
MF23034010	3/4"	10 mm
MF23034015	3/4"	15 mm
MF23034020	3/4"	20 mm
MF23034025	3/4"	25 mm
MF23034030	3/4"	30 mm
MF23034040	3/4"	40 mm
MF23034050	3/4"	50 mm
MF23034080	3/4"	80 mm
MF23034100	3/4"	100 mm
MF2301015	1"	15 mm
MF2301020	1"	20 mm
MF2301025	1"	25 mm
MF2301030	1"	30 mm
MF2301040	1"	40 mm
MF2301050	1"	50 mm
MF23054015	5/4"	15 mm
MF23054030	5/4"	30 mm



NR 240 - MESSING VERLOOPMOF

2X BINNENDRAAD

Bestelnr	Maten
MF2401418	1/4" x 1/8"
MF2403818	3/8" x 1/8"
MF2403814	3/8" x 1/4"
MF2401214	1/2" x 1/4"
MF2401238	1/2" x 3/8"
MF2403414	3/4" x 1/4"
MF2403438	3/4" x 3/8"
MF2403412	3/4" x 1/2"
MF240112	1" x 1/2"
MF240134	1" x 3/4"
MF240541	5/4" x 1"
MF240641	6/4" x 1"
MF2406454	6/4" x 5/4"
MF240264	2" x 6/4"

MESSING DRAADFITTINGEN

MESSING DRAADFITTINGEN



NR 241 - MESSING VERLOOPRING

BUITENDRAAD - BINNENDRAAD

Bestelnr	Maten
MF2411418	1/4" x 1/8"
MF2413814	3/8" x 1/4"
MF2413818	3/8" x 1/8"
MF2411214	1/2" x 1/4"
MF2411218	1/2" x 1/8"
MF2411238	1/2" x 3/8"
MF2413414	3/4" x 1/4"
MF2413438	3/4" x 3/8"
MF2413412	3/4" x 1/2"
MF2411114	1" x 1/4"
MF2411138	1" x 3/8"
MF2411112	1" x 1/2"
MF2411134	1" x 3/4"
MF2415412	5/4" x 1/2"
MF2415434	5/4" x 3/4"
MF241541	5/4" x 1"
MF2416412	6/4" x 1/2"
MF2416434	6/4" x 3/4"
MF241641	6/4" x 1"
MF2416454	6/4" x 5/4"
MF241234	2" x 3/4"
MF24121	2" x 1"
MF241254	2" x 5/4"
MF241264	2" x 6/4"
MF241252	2 1/2" x 2"
MF24132	3" x 2"
MF241325	3" x 2 1/2"

NR 245 - MESSING VERLOOPNIPPEL

2X BUITENDRAAD

Bestelnr	Maten
MF2451418	1/4" x 1/8"
MF2453818	3/8" x 1/8"
MF2453814	3/8" x 1/4"
MF2451218	1/2" x 1/8"
MF2451214	1/2" x 1/4"
MF2451238	1/2" x 3/8"
MF2453414	3/4" x 1/4"
MF2453412	3/4" x 1/2"
MF2453438	3/4" x 3/8"
MF245112	1" x 1/2"
MF245134	1" x 3/4"
MF245138	1" x 3/8"
MF2455412	5/4" x 1/2"
MF2455434	5/4" x 3/4"
MF245541	5/4" x 1"
MF2456412	6/4" x 1/2"
MF2456434	6/4" x 3/4"
MF245641	6/4" x 1"
MF2456454	6/4" x 5/4"
MF24521	2" x 1"
MF245254	2" x 5/4"
MF245264	2" x 6/4"

MESSING DRAADFITTINGEN



NR 246 - MESSING SOKNIPPEL

BINNENDRAAD - BUITENDRAAD

Bestelnr	Maten
MF2461418	1/4" x 1/8"
MF2463818	3/8" x 1/8"
MF2463814	3/8" x 1/4"
MF2461214	1/2" x 1/4"
MF2461238	1/2" x 3/8"
MF2463438	3/4" x 3/8"
MF2463412	3/4" x 1/2"
MF246138	1" x 3/8"
MF246112	1" x 1/2"
MF246134	1" x 3/4"
MF246541	5/4" x 1"
MF246641	6/4" x 1"
MF2466454	6/4" x 5/4"
MF246264	2" x 6/4"



NR 270 - MESSING MOF

2X BINNENDRAAD

Bestelnr	Maat
MF27018	1/8"
MF27014	1/4"
MF27038	3/8"
MF27012	1/2"
MF27034	3/4"
MF2701	1"
MF27054	5/4"
MF27064	6/4"
MF2702	2"
MF27025	2 1/2"
MF2703	3"

MESSING DRAADFITTINGEN

MESSING DRAADFITTINGEN



NR 280 - MESSING DUBBELE NIPPEL

2X BUITENDRAAD

Bestelnr	Maat
MF28018	1/8"
MF28014	1/4"
MF28038	3/8"
MF28012	1/2"
MF28034	3/4"
MF2801	1"
MF28054	5/4"
MF28064	6/4"
MF2802	2"
MF28025	2 1/2"
MF2803	3"



NR 290 - MESSING PLUG

BUITENDRAAD

Bestelnr	Maat
MF29018	1/8"
MF29014	1/4"
MF29038	3/8"
MF29012	1/2"
MF29034	3/4"
MF2901	1"
MF29054	5/4"
MF29064	6/4"
MF2902	2"
MF29025	2 1/2"
MF2903	3"



NR 300 - MESSING DOP

BINNENDRAAD

Bestelnr	Maat
MF30018	1/8"
MF30014	1/4"
MF30038	3/8"
MF30012	1/2"
MF30034	3/4"
MF3001	1"
MF30054	5/4"
MF30064	6/4"
MF3002	2"

NR 310 - MESSING TEGENMOER

BINNENDRAAD

Bestelnr	Maat
MF31014	1/4"
MF31038	3/8"
MF31012	1/2"
MF31034	3/4"
MF3101	1"
MF31054	5/4"
MF31064	6/4"
MF3102	2"

MESSING DRAADFITTINGEN



NR 340 - MESSING RACCORD

2X BINNENDRAAD

Bestelnr	Maat
MF34012	1/2"
MF34034	3/4"
MF3401	1"
MF34054	5/4"
MF34064	6/4"
MF3402	2"



NR 341 - MESSING RACCORD

BINNENDRAAD - BUITENDRAAD

Bestelnr	Maat
MF34112	1/2"
MF34134	3/4"
MF3411	1"
MF34154	5/4"
MF34164	6/4"
MF3412	2"



NR 471 - MESSING MUURPLAAT

BINNENDRAAD

Bestelnr	Maat
MF47112	1/2"
MF47134	3/4"



NR 531 - MESSING NIPPEL GLAD

BUITENDRAAD

Bestelnr	Maat
MF53114	1/4"
MF53112	1/2"
MF53134	3/4"
MF5311	1"
MF53154	5/4"
MF53164	6/4"
MF5312	2"

MESSING DRAADFITTINGEN



NR 1121 - MESSING DOORVOERKOPPELING

BUITENDRAAD

Bestelnr	Maat
MF112114	1/4"
MF112138	3/8"
MF112112	1/2"
MF112134	3/4"
MF112111	1"
MF112154	5/4"
MF112164	6/4"
MF11212	2"
MF112125	2 1/2"
MF11213	3"

NR 23 - MESSING PIJPNIPPEL

BUITENDRAAD

Bestelnr	Maat	Lengte
MFBUL14040	1/4"	40 mm
MFBUL14060	1/4"	60 mm
MFBUL14080	1/4"	80 mm
MFBUL14100	1/4"	100 mm
MFBUL38040	3/8"	40 mm
MFBUL38060	3/8"	60 mm
MFBUL12040	1/2"	40 mm
MFBUL12060	1/2"	60 mm
MFBUL12080	1/2"	80 mm
MFBUL12100	1/2"	100 mm
MFBUL12120	1/2"	120 mm
MFBUL12150	1/2"	150 mm
MFBUL12180	1/2"	180 mm
MFBUL12200	1/2"	200 mm
MFBUL34040	3/4"	40 mm
MFBUL34060	3/4"	60 mm
MFBUL34080	3/4"	80 mm
MFBUL34100	3/4"	100 mm
MFBUL34120	3/4"	120 mm
MFBUL34150	3/4"	150 mm
MFBUL34200	3/4"	200 mm
MFBUL1060	1"	60 mm
MFBUL1080	1"	80 mm
MFBUL1100	1"	100 mm
MFBUL1120	1"	120 mm
MFBUL1150	1"	150 mm
MFBUL1200	1"	200 mm
MFBUL1300	1"	300 mm

MESSING DRAADFITTINGEN



NR 23 - MESSING PIJPNIPPEL

BUITENDRAAD

Bestelnr	Maat	Lengte
MFBUL54060	5/4"	60 mm
MFBUL54100	5/4"	100 mm
MFBUL54150	5/4"	150 mm
MFBUL54200	5/4"	200 mm
MFBUL64060	6/4"	60 mm
MFBUL64080	6/4"	80 mm
MFBUL64100	6/4"	100 mm
MFBUL64120	6/4"	120 mm
MFBUL64150	6/4"	150 mm
MFBUL64200	6/4"	200 mm
MFBUL2060	2"	60 mm
MFBUL2080	2"	80 mm
MFBUL2120	2"	120 mm
MFBUL2200	2"	200 mm
MFBUL2300	2"	300 mm



MESSING DRAADEIND

BUITENDRAAD

Bestelnr	Maat	Lengte
MF1120120065	1/2"	65 mm
MF1120120080	1/2"	80 mm
MF1120120100	1/2"	100 mm
MF1120120120	1/2"	120 mm
MF1120340065	3/4"	65 mm
MF1120340080	3/4"	80 mm
MF1120340100	3/4"	100 mm
MF1120340120	3/4"	120 mm

NOTITIES

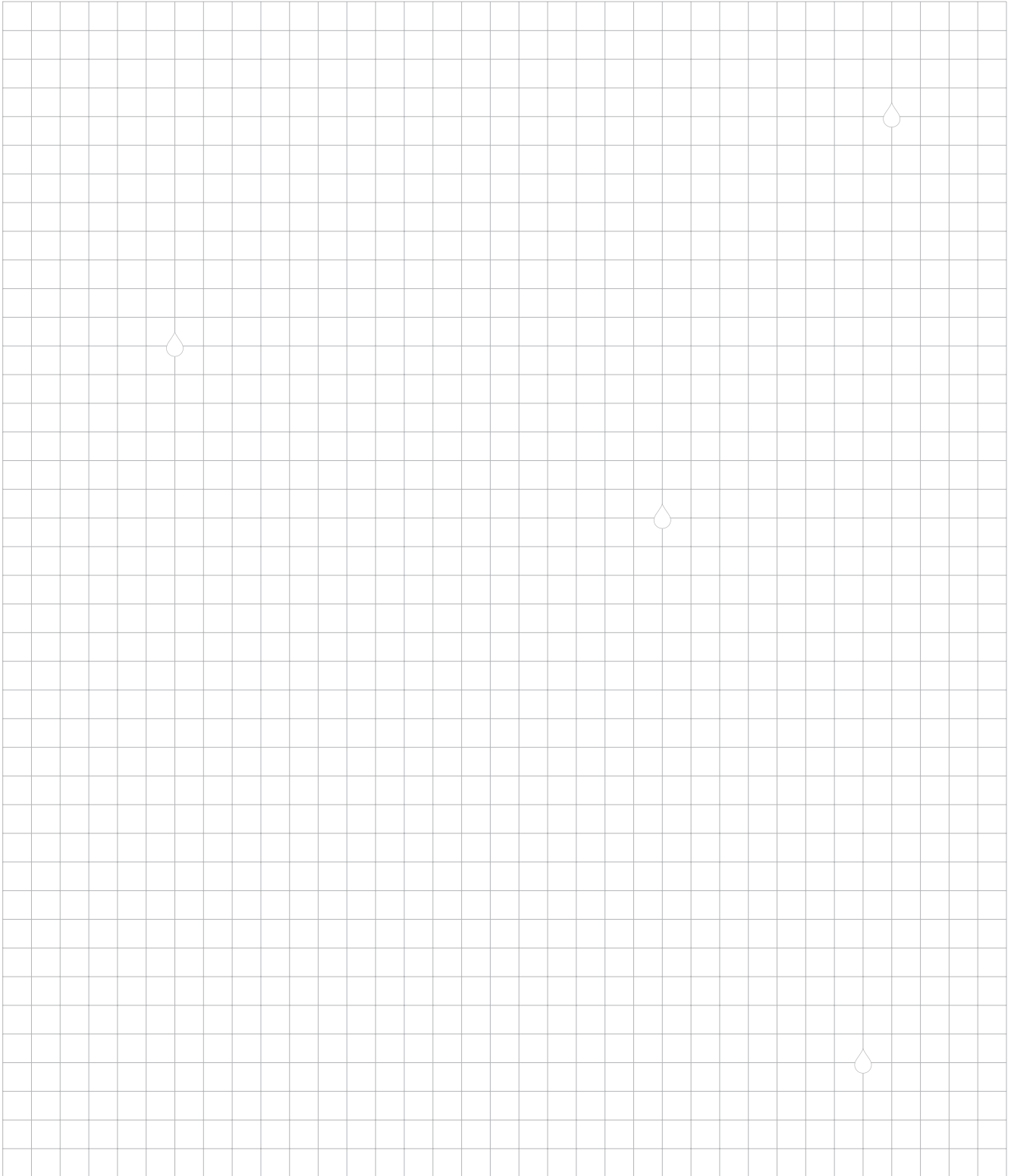

— DEEL 4 —

RVS DRAAD- & LASFITTINGEN

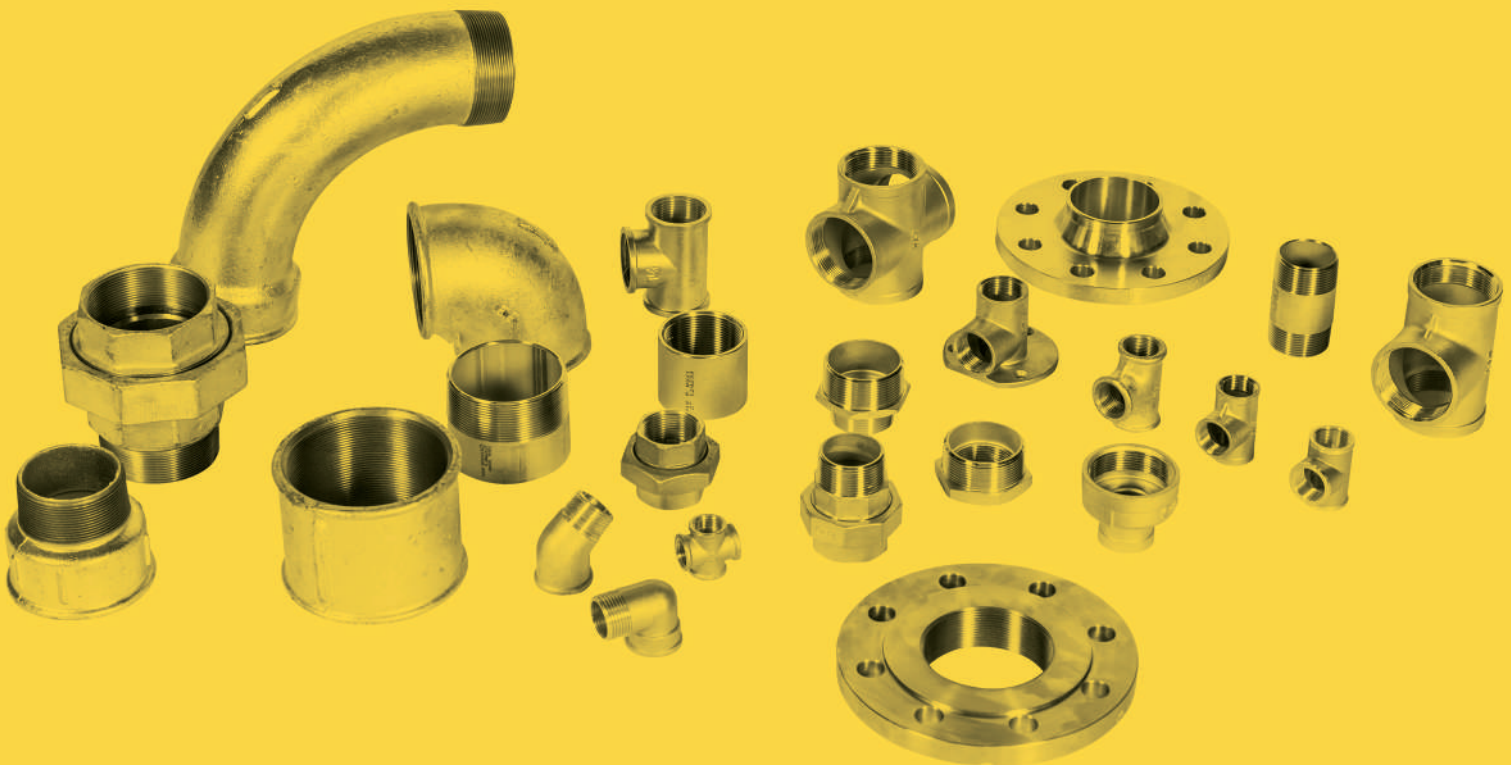

RVS DRAAD- & LASFITTINGEN

— RVS 304 & RVS 316 —

Gelaste RVS buizen	82
RVS draadfittingen	83
RVS pijpnippels	92
RVS lasfittingen	94
RVS lastules	98
RVS flenzen	99

RVS DRAAD- & LASFITTINGEN

GELASTE RVS BUIZEN



LANGSNAAD GELASTE RVS BUIS

RVS 304 & RVS 316

Bestelnr	Maat	Wanddikte	Lengte
9LABU00600010	6,00 mm	1,00 mm	6 m
9LABU00800010	8,00 mm	1,00 mm	6 m
9LABU01000010	10,00 mm	1,00 mm	6 m
9LABU01200015	12,00 mm	1,50 mm	6 m
9LABU01400015	14,00 mm	1,50 mm	6 m
9LABU01500015	15,00 mm	1,50 mm	6 m
9LABU01600020	16,00 mm	2,00 mm	6 m
9LABU01700016	17,15 mm	1,65 mm	6 m
9LABU01720023	17,20 mm	2,30 mm	6 m
9LABU01800015	18,00 mm	1,50 mm	6 m
9LABU02000015	20,00 mm	1,50 mm	6 m
9LABU02130026	21,30 mm	2,60 mm	6 m
9LABU02134021	21,34 mm	2,11 mm	6 m
9LABU02200015	22,00 mm	1,50 mm	6 m
9LABU02250015	25,00 mm	1,50 mm	6 m
9LABU02540012	25,40 mm	1,25 mm	6 m
9LABU02667021	26,67 mm	2,11 mm	6 m
9LABU02690026	26,90 mm	2,60 mm	6 m
9LABU02800015	28,00 mm	1,50 mm	6 m
9LABU03000020	30,00 mm	2,00 mm	6 m
9LABU03200020	32,00 mm	2,00 mm	6 m
9LABU03340027	33,40 mm	2,77 mm	6 m
9LABU03370020	33,70 mm	2,00 mm	6 m
9LABU03800020	38,00 mm	2,00 mm	6 m
9LABU04000015	40,00 mm	1,50 mm	6 m
9LABU04216027	42,16 mm	2,77 mm	6 m
9LABU04240020	42,40 mm	2,00 mm	6 m
9LABU04300015	43,00 mm	1,50 mm	6 m
9LABU04450020	44,50 mm	2,00 mm	6 m
9LABU04826027	48,26 mm	2,77 mm	6 m
9LABU04830020	48,30 mm	2,00 mm	6 m
9LABU05080015	50,80 mm	1,50 mm	6 m
9LABU05200015	52,00 mm	1,50 mm	6 m

LANGSNAAD GELASTE RVS BUIS

RVS 304 & RVS 316

Bestelnr	Maat	Wanddikte	Lengte
9LABU05400020	54,00 mm	2,00 mm	6 m
9LABU06030020	60,30 mm	2,00 mm	6 m
9LABU06033027	60,33 mm	2,77 mm	6 m
9LABU07000020	70,00 mm	2,00 mm	6 m
9LABU07303030	73,03 mm	3,05 mm	6 m
9LABU07610020	76,10 mm	2,00 mm	6 m
9LABU08400020	84,00 mm	2,00 mm	6 m
9LABU08890020	88,90 mm	3,05 mm	6 m
9LABU10400020	104,00 mm	2,00 mm	6 m
9LABU10800020	108,00 mm	2,00 mm	6 m
9LABU11430020	114,30 mm	2,00 mm	6 m
9LABU11430030	114,30 mm	3,05 mm	6 m
9LABU12900020	129,00 mm	2,00 mm	6 m
9LABU13970020	139,70 mm	2,00 mm	6 m
9LABU13970030	139,70 mm	3,00 mm	6 m
9LABU14130034	141,30 mm	3,40 mm	6 m
9LABU15400020	154,00 mm	2,00 mm	6 m
9LABU15600030	156,00 mm	3,00 mm	6 m
9LABU16828020	168,28 mm	2,00 mm	6 m
9LABU16828034	168,28 mm	3,40 mm	6 m
9LABU20400020	204,00 mm	2,00 mm	6 m
9LABU20600030	206,00 mm	3,00 mm	6 m
9LABU21908037	219,08 mm	3,76 mm	6 m
9LABU25400020	254,00 mm	2,00 mm	6 m
9LABU25600030	256,00 mm	3,00 mm	6 m
9LABU27305041	273,05 mm	4,19 mm	6 m
9LABU30400020	304,00 mm	2,00 mm	6 m
9LABU30600030	306,00 mm	3,00 mm	6 m
9LABU32385045	323,85 mm	4,57 mm	6 m
9LABU35600030	356,00 mm	3,00 mm	6 m
9LABU40600030	406,00 mm	3,00 mm	6 m
9LABU50600030	506,00 mm	3,00 mm	6 m

RVS DRAAD- & LASFITTINGEN

RVS DRAADFITTINGEN



NR 3 - LANGE BOCHT 90°

RVS 316 | 2X BUITENDRAAD

Bestelnr	Maat
9ZF314	1/4"
9ZF312	1/2"
9ZF31	1"
9ZF32	2"

NR 90 - KNIE 90°

RVS 316 | 2X BINNENDRAAD

Bestelnr	Maat
9ZF9018	1/8"
9ZF9014	1/4"
9ZF9038	3/8"
9ZF9012	1/2"
9ZF9034	3/4"
9ZF901	1"
9ZF9054	5/4"
9ZF9064	6/4"
9ZF902	2"
9ZF9025	2 1/2"
9ZF903	3"
9ZF904	4"

RVS DRAAD- & LASFITTINGEN

RVS DRAADFITTINGEN



NR 92 - KNIE 90°

RVS 316 | BINNENDRAAD - BUITENDRAAD

Bestelnr	Maat
9ZF9218	1/8"
9ZF9214	1/4"
9ZF9238	3/8"
9ZF9212	1/2"
9ZF9234	3/4"
9ZF921	1"
9ZF9254	5/4"
9ZF9264	6/4"
9ZF922	2"
9ZF9225	2 1/2"
9ZF923	3"
9ZF924	4"



NR 120 - KNIE 45°

RVS 316 | 2X BINNENDRAAD

Bestelnr	Maat
9ZF12018	1/8"
9ZF12014	1/4"
9ZF12038	3/8"
9ZF12012	1/2"
9ZF12034	3/4"
9ZF1201	1"
9ZF12054	5/4"
9ZF12064	6/4"
9ZF1202	2"
9ZF12025	2 1/2"
9ZF1203	3"
9ZF1204	4"

RVS DRAAD- & LASFITTINGEN

RVS DRAADFITTINGEN



NR 121 - KNIE 45°

RVS 316 | BINNENDRAAD - BUITENDRAAD

Bestelnr	Maat
9ZF12114	1/4"
9ZF12138	3/8"
9ZF12112	1/2"
9ZF12134	3/4"
9ZF1211	1"
9ZF12154	5/4"
9ZF12164	6/4"
9ZF1212	2"
9ZF121125	2 1/2"
9ZF1213	33

NR 130 - T-STUK 90°

RVS 316 | 3X BINNENDRAAD

Bestelnr	Maat
9ZF13018	1/8"
9ZF13014	1/4"
9ZF13038	3/8"
9ZF13012	1/2"
9ZF1303412	3/4" x 1/2" x 3/4"
9ZF13034	3/4"
9ZF1301	1"
9ZF13054	5/4"
9ZF13064	6/4"
9ZF1302	2"
9ZF13025	2 1/2"
9ZF1303	3"
9ZF1304	4"

RVS DRAAD- & LASFITTINGEN

RVS DRAADFITTINGEN



NR 180 - KRUISSTUK

RVS 316 | 4X BINNENDRAAD

Bestelnr	Maat
9ZF18014	1/4"
9ZF18038	3/8"
9ZF18012	1/2"
9ZF18034	3/4"
9ZF1801	1"
9ZF18054	5/4"
9ZF18064	6/4"
9ZF1802	2"
9ZF18025	2 1/2"
9ZF1803	3"
9ZF1804	4"

NR 240 - VERLOOPMOF

RVS 316 | 2X BINNENDRAAD

Bestelnr	Maat
9ZF2401418	1/4" x 1/8"
9ZF2403814	3/8" x 1/4"
9ZF2401218	1/2" x 1/8"
9ZF2401214	1/2" x 1/4"
9ZF2401238	1/2" x 3/8"
9ZF2403414	3/4" x 1/4"
9ZF2403438	3/4" x 3/8"
9ZF2403412	3/4" x 1/2"
9ZF240114	1" x 1/4"
9ZF240138	1" x 3/8"
9ZF240112	1" x 1/2"
9ZF240134	1" x 3/4"
9ZF2405412	5/4" x 1/2"
9ZF2405434	5/4" x 3/4"
9ZF240541	5/4" x 1"
9ZF2406412	6/4" x 1/2"
9ZF2406434	6/4" x 3/4"
9ZF240641	6/4" x 1"
9ZF2406454	6/4" x 5/4"
9ZF240212	2" x 1/2"
9ZF240234	2" x 3/4"
9ZF24021	2" x 1"
9ZF240254	2" x 5/4"
9ZF240264	2" x 6/4"
9ZF2402564	2 1/2" x 6/4"
9ZF240252	2 1/2" x 2"
9ZF240364	3" x 6/4"
9ZF24032	3" x 2"
9ZF240325	3" x 2 1/2"
9ZF24043	4" x 3"



NR 241 - VERLOOPRING

RVS 316 | BUITENDRAAD - BINNENDRAAD

Bestelnr	Maat
9ZF2411418	1/4" x 1/8"
9ZF2413818	3/8" x 1/8"
9ZF2413814	3/8" x 1/4"
9ZF2411218	1/2" x 1/8"
9ZF2411214	1/2" x 1/4"
9ZF2411238	1/2" x 3/8"
9ZF2413414	3/4" x 1/4"
9ZF2413412	3/4" x 1/2"
9ZF2413438	3/4" x 3/8"
9ZF241114	1" x 1/4"
9ZF241112	1" x 1/2"
9ZF241138	1" x 3/8"
9ZF241134	1" x 3/4"
9ZF2415412	5/4" x 1/2"
9ZF2415434	5/4" x 3/4"
9ZF241541	5/4" x 1"
9ZF2416412	6/4" x 1/2"
9ZF2416434	6/4" x 3/4"
9ZF241641	6/4" x 1"
9ZF2416454	6/4" x 5/4"
9ZF241212	2" x 1/2"
9ZF241234	2" x 3/4"
9ZF24121	2" x 1"
9ZF241254	2" x 5/4"
9ZF241264	2" x 6/4"
9ZF241251	2 1/2" x 1"
9ZF2412564	2 1/2" x 6/4"
9ZF241252	2 1/2" x 2"
9ZF241364	3" x 6/4"
9ZF24132	3" x 2"
9ZF241325	3" x 2 1/2"
9ZF24142	4" x 2"
9ZF24143	4" x 3"

NR 245 - VERLOOPNIPPEL

RVS 316 | 2X BUITENDRAAD

Bestelnr	Maat
9ZF2451418	1/4" x 1/8"
9ZF2453818	3/8" x 1/8"
9ZF2453814	3/8" x 1/4"
9ZF2451218	1/2" x 1/8"
9ZF2451214	1/2" x 1/4"
9ZF2451238	1/2" x 3/8"
9ZF2453414	3/4" x 1/4"
9ZF2453412	3/4" x 1/2"
9ZF2453438	3/4" x 3/8"
9ZF245114	1" x 1/4"
9ZF245138	1" x 3/8"
9ZF245112	1" x 1/2"
9ZF245134	1" x 3/4"
9ZF2455412	5/4" x 1/2"
9ZF2455434	5/4" x 3/4"
9ZF245541	5/4" x 1"
9ZF2456412	6/4" x 1/2"
9ZF2456434	6/4" x 3/4"
9ZF245641	6/4" x 1"
9ZF2456454	6/4" x 5/4"
9ZF24521	2" x 1"
9ZF245254	2" x 5/4"
9ZF245264	2" x 6/4"
9ZF2452564	2 1/2" x 6/4"
9ZF245252	2 1/2" x 2"
9ZF24532	3" x 2"
9ZF245325	3" x 2 1/2"
9ZF245425	4" x 2 1/2"
9ZF24543	4" x 3"

RVS DRAAD- & LASFITTINGEN

RVS DRAADFITTINGEN



NR 270 - MOF

RVS 316 | 2X BINNENDRAAD

Bestelnr	Maat
9ZF27018	1/8"
9ZF27014	1/4"
9ZF27038	3/8"
9ZF27012	1/2"
9ZF27034	3/4"
9ZF2701	1"
9ZF27054	5/4"
9ZF27064	6/4"
9ZF2702	2"
9ZF27025	2 1/2"
9ZF2703	3"
9ZF2704	4"



NR 280 - DUBBELE NIPPEL

RVS 316 | 2X BUITENDRAAD

Bestelnr	Maat
9ZF28018	1/8"
9ZF28014	1/4"
9ZF28038	3/8"
9ZF28012	1/2"
9ZF28034	3/4"
9ZF2801	1"
9ZF28054	5/4"
9ZF28064	6/4"
9ZF2802	2"
9ZF28025	2 1/2"
9ZF2803	3"
9ZF2804	4"

RVS DRAAD- & LASFITTINGEN

RVS DRAADFITTINGEN



NR 290 - PLUG

RVS 316 | BUITENDRAAD

Bestelnr	Maat
9ZF29018	1/8"
9ZF29014	1/4"
9ZF29038	3/8"
9ZF29012	1/2"
9ZF29034	3/4"
9ZF2901	1"
9ZF29054	5/4"
9ZF29064	6/4"
9ZF2902	2"
9ZF29025	2 1/2"
9ZF2903	3"
9ZF2904	4"

NR 300 - DOP ZESKANT

RVS 316 | BINNENDRAAD

Bestelnr	Maat
9ZF30018	1/8"
9ZF30014	1/4"
9ZF30038	3/8"
9ZF30012	1/2"
9ZF30034	3/4"
9ZF3001	1"
9ZF30054	5/4"
9ZF30064	6/4"
9ZF3002	2"
9ZF30025	2 1/2"
9ZF3003	3"
9ZF3004	4"

RVS DRAAD- & LASFITTINGEN

RVS DRAADFITTINGEN



NR 312 - TEGENMOER

RVS 316 | BINNENDRAAD

Bestelnr	Maat
9ZF31238	3/8"
9ZF31212	1/2"
9ZF31234	3/4"
9ZF31201	1"
9ZF31254	5/4"



NR 340 - RACCORD

RVS 316 | 2X BINNENDRAAD

Bestelnr	Maat
9ZF34014	1/4"
9ZF34038	3/8"
9ZF34012	1/2"
9ZF34034	3/4"
9ZF3401	1"
9ZF34054	5/4"
9ZF34064	6/4"
9ZF3402	2"
9ZF34025	2 1/2"
9ZF3403	3"
9ZF3404	4"



NR 341 - RACCORD

RVS 316 | BINNENDRAAD - BUITENDRAAD

Bestelnr	Maat
9ZF34118	1/8"
9ZF34114	1/4"
9ZF34138	3/8"
9ZF34112	1/2"
9ZF34134	3/4"
9ZF3411	1"
9ZF34154	5/4"
9ZF34164	6/4"
9ZF3412	2"
9ZF34125	2 1/2"
9ZF3413	3"
9ZF3414	4"



NR 471 - MUURKNIE

RVS 316 | 2X BINNENDRAAD

Bestelnr	Maat
9ZF47112	1/2"
9ZF47134	3/4"
9ZF4711	1"

RVS DRAAD- & LASFITTINGEN

RVS PIJPNIPPELS



NR 23 - PIJPNIPPEL

RVS 316 | BUITENDRAAD

Bestelnr	Maat	Lengte
9BUL140040	1/4"	40 mm
9BUL140100	1/4"	100 mm
9BUL380040	3/8"	40 mm
9BUL120060	1/2"	60 mm
9BUL120080	1/2"	80 mm
9BUL120100	1/2"	100 mm
9BUL120120	1/2"	120 mm
9BUL120150	1/2"	150 mm
9BUL120200	1/2"	200 mm
9BUL120300	1/2"	300 mm
9BUL120500	1/2"	500 mm
9BUL120750	1/2"	750 mm
9BUL340060	3/4"	60 mm
9BUL340150	3/4"	150 mm
9BUL340200	3/4"	200 mm
9BUL340300	3/4"	300 mm
9BUL10060	1"	60 mm
9BUL10150	1"	150 mm
9BUL10200	1"	200 mm
9BUL10300	1"	300 mm
9BUL540080	5/4"	80 mm
9BUL540150	5/4"	150 mm
9BUL540300	5/4"	300 mm
9BUL640080	6/4"	80 mm
9BUL640150	6/4"	150 mm
9BUL640300	6/4"	300 mm
9BUL20100	2"	100 mm
9BUL20150	2"	150 mm
9BUL20300	2"	300 mm
9BUL250100	2 1/2"	100 mm
9BUL250200	2 1/2"	200 mm
9BUL30120	3"	120 mm
9BUL30200	3"	200 mm
9BUL40120	4"	120 mm

NOTITIES

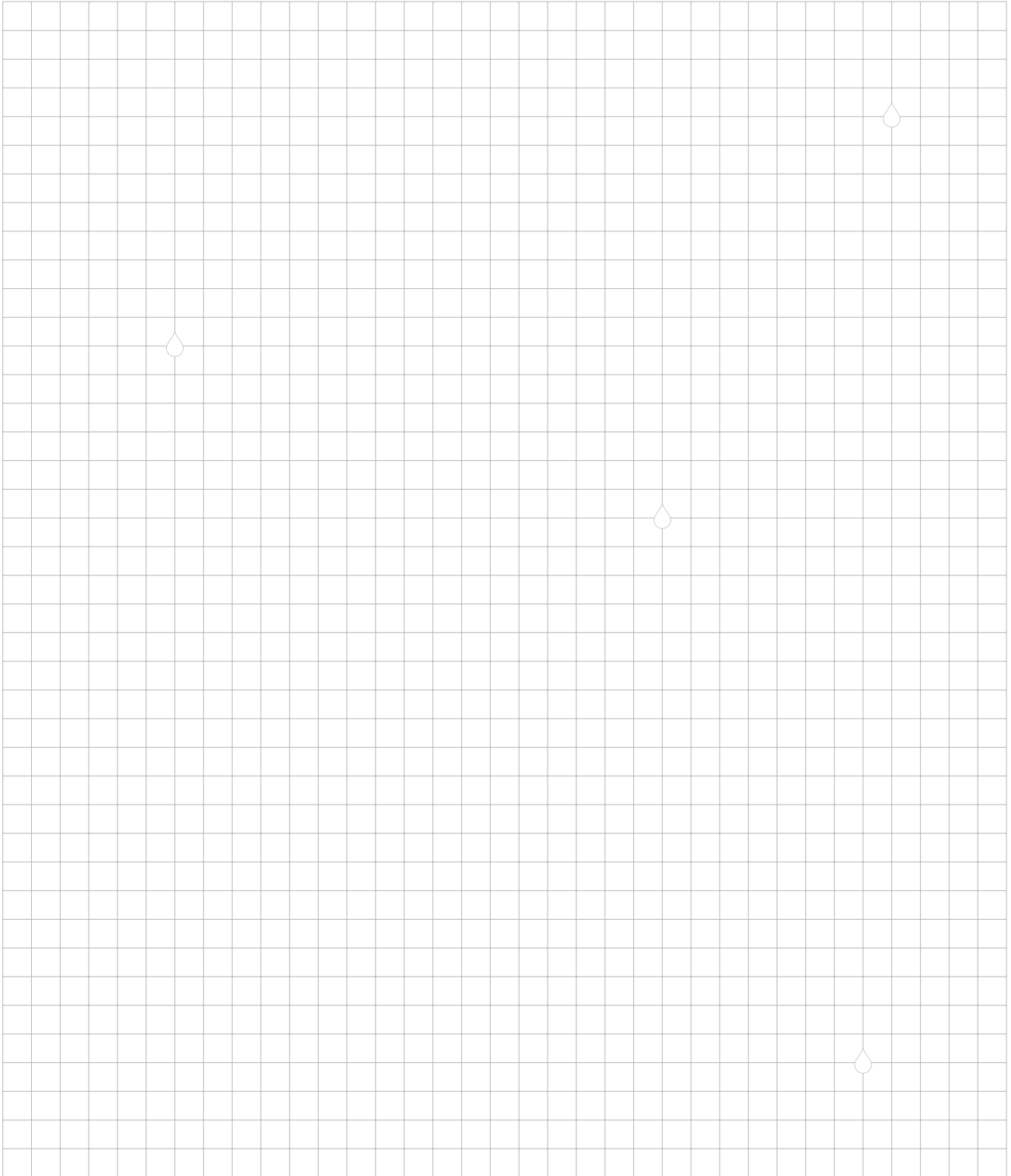

RVS DRAAD- & LASFITTINGEN

RVS LASFITTINGEN



3D LASBOCHT 90°

RVS 304 & RVS 316

Bestelnr	Maat	Wanddikte
9LAK017290	17,2 mm	1,6 mm
9LAK018090	18,0 mm	1,5 mm
9LAK021390	21,3 mm	2,0 mm
9LAK023090	23,0 mm	1,5 mm
9LAK025090	25,0 mm	2,0 mm
9LAK026990	26,9 mm	2,0 mm
9LAK028090	28,0 mm	1,5 mm
9LAK030090	30,0 mm	2,0 mm
9LAK033790	33,7 mm	2,0 mm
9LAK038090	38,0 mm	1,5 mm
9LAK040090	40,0 mm	1,5 mm
9LAK042490	42,4 mm	2,0 mm
9LAK043090	43,0 mm	1,5 mm
9LAK044590	44,5 mm	2,0 mm
9LAK048390	48,3 mm	2,0 mm
9LAK052090	52,0 mm	1,5 mm
9LAK053090	53,0 mm	1,5 mm
9LAK060390	60,3 mm	2,0 mm
9LAK070090	70,0 mm	2,0 mm
9LAK076190	76,1 mm	2,0 mm
9LAK084090	84,0 mm	2,0 mm



3D LASBOCHT 90°

RVS 304 & RVS 316

Bestelnr	Maat	Wanddikte
9LAK088990	88,9 mm	2,0 mm
9LAK104090	104,0 mm	2,0 mm
9LAK114390	114,3 mm	2,0 mm
9LAK129090	129,0 mm	2,0 mm
9LAK139790	139,7 mm	2,0 mm
9LAK154090	154,0 mm	2,0 mm
9LAK156090	156,0 mm	3,0 mm
9LAK168390	168,3 mm	2,0 mm
9LAK204090	204,0 mm	2,0 mm
9LAK206090	206,0 mm	3,0 mm
9LAK219190	219,1 mm	2,0 mm
9LAK254090	254,0 mm	2,0 mm
9LAK256090	256,0 mm	3,0 mm
9LAK273190	273,1 mm	3,0 mm
9LAK304090	304,0 mm	2,0 mm
9LAK306090	306,0 mm	3,0 mm
9LAK323990	323,9 mm	3,0 mm
9LAK356090	356,0 mm	3,0 mm
9LAK406090	406,0 mm	3,0 mm
9LAK456090	456,0 mm	3,0 mm
9LAK506090	506,0 mm	3,0 mm



LAS T-STUK 90°

RVS 304 & RVS 316



RVS BUISBODEM

RVS 304 & RVS 316

Bestelnr	Maat	Wanddikte
9LAT0172	17,2 mm	1,6 mm
9LAT0213	21,3 mm	2,0 mm
9LAT0269	26,9 mm	2,0 mm
9LAT0334	33,4 mm	2,0 mm
9LAT0337	33,7 mm	2,0 mm
9LAT0423	42,3 mm	2,0 mm
9LAT0424	42,4 mm	2,0 mm
9LAT0483	48,3 mm	2,0 mm
9LAT0540	54,0 mm	2,0 mm
9LAT0603	60,3 mm	2,0 mm
9LAT0761	76,1 mm	2,0 mm
9LAT0840	84,0 mm	2,0 mm
9LAT0889	88,9 mm	2,0 mm
9LAT10404	104,0 mm	2,0 mm
9LAT10406	104,0 mm	2,0 mm
9LAT1143	114,3 mm	2,0 mm
9LAT1397	139,7 mm	2,0 mm
9LAT1540	154,0 mm	2,0 mm
9LAT1683	168,3 mm	2,0 mm
9LAT2040	204,0 mm	2,0 mm
9LAT2060	206,0 mm	3,0 mm
9LAT2191	219,1 mm	2,0 mm
9LAT2540	254,0 mm	2,0 mm
9LAT2560	256,0 mm	3,0 mm
9LAT2730	273,0 mm	3,0 mm
9LAT3040	304,0 mm	2,0 mm
9LAT3060	306,0 mm	3,0 mm
9LAT3299	329,9 mm	2,0 mm
9LAT3560	356,0 mm	3,0 mm
9LAT4063	406,3 mm	3,0 mm

Bestelnr	Maat	Wanddikte
9LAE0213	21,3 mm	2,0 mm
9LAE0269	26,9 mm	2,0 mm
9LAE0337	33,7 mm	2,0 mm
9LAE0424	42,4 mm	2,0 mm
9LAE0483	48,3 mm	2,0 mm
9LAE0603	60,3 mm	2,0 mm
9LAE0761	76,1 mm	2,0 mm
9LAE0889	88,9 mm	2,0 mm
9LAE1040	104,0 mm	2,0 mm
9LAE1143	114,3 mm	2,0 mm
9LAE1397	139,7 mm	3,0 mm
9LAE1540	154,0 mm	3,0 mm
9LAE1683	168,3 mm	3,0 mm
9LAE2191	219,1 mm	3,0 mm
9LAE2730	273,0 mm	2,0 mm
9LAE3239	323,9 mm	3,0 mm
9LAE3560	356,0 mm	3,0 mm
9LAE4064	406,4 mm	3,0 mm
9LAE5080	508,0 mm	3,0 mm

RVS DRAAD- & LASFITTINGEN

RVS LASFITTINGEN



LASVERLOOPSTUK CONCENTRISCH

RVS 304 & RVS 316

Bestelnr	Maat	Wanddikte
9LAR021017	21,3 mm x 17,2 mm	2,0 mm
9LAR026021	26,9 mm X 21,3mm	2,0 mm
9LAR033021	33,7 mm x 21,3 mm	2,0 mm
9LAR033026	33,7 mm x 26,9 mm	2,0 mm
9LAR042021	42,4 mm x 21,9 mm	2,0 mm
9LAR042026	42,4 mm x 26,9 mm	2,0 mm
9LAR042033	42,4 mm x 33,4 mm	2,0 mm
9LAR048021	48,3 mm X 21,3 mm	2,0 mm
9LAR048026	48,3 mm x 26,9 mm	2,0 mm
9LAR048033	48,3 mm x 33,4 mm	2,0 mm
9LAR048042	48,3 mm x 42,4 mm	2,0 mm
9LAR053043	53,0 mm x 43,0 mm	2,0 mm
9LAR060026	60,3 mm x 26,9 mm	2,0 mm
9LAR060033	60,3 mm x 33,4 mm	2,0 mm
9LAR060042	60,3 mm x 42,4 mm	2,0 mm
9LAR060048	60,3 mm x 48,3 mm	2,0 mm
9LAR063053	63,0 mm x 53,0 mm	2,0 mm
9LAR073048	73,3 mm x 48,3 mm	2,0 mm
9LAR073063	73,0 mm x 63,0 mm	2,0 mm
9LAR076033	76,1 mm x 33,7 mm	2,0 mm
9LAR076042	76,1 mm x 42,4 mm	2,0 mm
9LAR076048	76,1 mm x 48,3 mm	2,0 mm
9LAR076060	76,1 mm x 60,3 mm	2,0 mm
9LAR080060	80,0 mm x 60,0 mm	2,0 mm
9LAR084073	84,0 mm x 73,0 mm	2,0 mm
9LAR085070	85,0 mm x 70,0 mm	2,0 mm
9LAR088033	88,9 mm x 33,7 mm	2,0 mm
9LAR088042	88,9 mm x 42,4 mm	2,0 mm
9LAR088048	88,9 mm x 48,3 mm	2,0 mm
9LAR088060	88,9 mm x 60,3 mm	2,0 mm
9LAR088076	88,9 mm x 76,1 mm	2,0 mm
9LAR100060	100,0 mm x 60,0 mm	2,0 mm
9LAR100080	100,0 mm x 80,0 mm	2,0 mm

LASVERLOOPSTUK CONCENTRISCH

RVS 304 & RVS 316

Bestelnr	Maat	Wanddikte
9LAR104054	104,0 mm x 54,0 mm	2,0 mm
9LAR104084	104,0 mm x 84,0 mm	2,0 mm
9LAR114034	114,3 mm x 33,7 mm	2,0 mm
9LAR114042	114,3 mm x 42,4 mm	2,0 mm
9LAR114048	114,3 mm x 48,3 mm	2,0 mm
9LAR114060	114,3 mm x 60,3 mm	2,0 mm
9LAR114073	114,3 mm x 73,3 mm	2,0 mm
9LAR114076	114,3 mm x 76,1 mm	2,0 mm
9LAR114088	114,3 mm x 88,9 mm	2,0 mm
9LAR120100	120,0 mm x 100,0 mm	2,0 mm
9LAR129104	129,0 mm x 104,0 mm	2,0 mm
9LAR139060	139,7 mm x 60,3 mm	2,0 mm
9LAR139076	139,7 mm x 76,1 mm	2,0 mm
9LAR139088	139,7 mm x 88,9 mm	2,0 mm
9LAR139114	139,7 mm x 114,3 mm	2,0 mm
9LAR150100	150,0 mm x 100,0 mm	2,0 mm
9LAR150120	150,0 mm x 120,0 mm	2,0 mm
9LAR154104	154,0 mm x 104,0 mm	2,0 mm
9LAR154129	154,0 mm x 129,0 mm	2,0 mm
9LAR168088	168,3 mm x 88,9 mm	2,0 mm
9LAR1681143	168,3 mm x 114,3 mm	2,0 mm
9LAR1681146	168, mm x 114x3 mm	2,0 mm
9LAR168139	168,3 mm x 139,7 mm	2,0 mm
9LAR204104	204,0 mm X 104,0 mm	2,0 mm
9LAR204154	204,0 mm x 154,0 mm	2,0 mm
9LAR219088	219,1 mm x 88,9 mm	2,0 mm
9LAR219114	219,1 mm X 114,3 mm	2,0 mm
9LAR219140	219,1 mm x 139,7 mm	2,0 mm
9LAR219168	219,1 mm x 168,3 mm	2,0 mm
9LAR254204	254,0 mm x 204,0 mm	2,0 mm
9LAR273168	273,0 mm x 168,3 mm	2,0 mm
9LAR273219	273,0 mm x 219,1 mm	2,0 mm



LASNIPPEL

RVS 316

Bestelnr	Maat	Lengte
9LAN14	1/4"	30 mm
9LAN38	3/8"	30 mm
9LAN12	1/2"	35 mm
9LAN34	3/4"	40 mm
9LAN1	1"	40 mm
9LAN54	5/4"	50 mm
9LAN64	6/4"	50 mm
9LAN2	2"	50 mm
9LAN25	2 1/2"	60 mm
9LAN3	3"	70 mm
9LAN4	4"	80 mm

RVS DRAAD- & LASFITTINGEN

RVS LASTULES



LASTULE

RVS 304 & RVS 316

Bestelnr	Maat	Lengte	Wanddikte
9LAS050100	50 mm	100 mm	1,5 mm
9LAS060110	60 mm	110 mm	1,5 mm
9LAS063110	63 mm	110 mm	1,5 mm
9LAS076130	76 mm	130 mm	1,5 mm
9LAS080110	80 mm	110 mm	1,5 mm
9LAS090150	90 mm	150 mm	1,5 mm
9LAS100140	100 mm	140 mm	1,5 mm
9LAS120140	120 mm	140 mm	1,5 mm
9LAS125150	125 mm	150 mm	1,5 mm
9LAS150150	150 mm	150 mm	1,5 mm
9LAS200250	200 mm	250 mm	1,5 mm
9LAS250300	250 mm	300 mm	2,0 mm

LASTULE GERIBD

RVS 304 & RVS 316

Bestelnr	Maat	Lengte	Wanddikte
9LASR020	20 mm	70 mm	1,5 mm
9LASR025	25 mm	70 mm	1,5 mm
9LASR030	30 mm	70 mm	1,5 mm
9LASR035	35 mm	70 mm	1,5 mm
9LASR040	40 mm	70 mm	1,5 mm
9LASR045	45 mm	70 mm	2,0 mm
9LASR050	50 mm	70 mm	2,0 mm
9LASR060	60 mm	75 mm	2,0 mm
9LASR065	65 mm	75 mm	2,0 mm
9LASR070	70 mm	90 mm	2,0 mm
9LASR075	75 mm	100 mm	2,0 mm
9LASR080	80 mm	100 mm	2,0 mm
9LASR090	90 mm	110 mm	2,0 mm
9LASR100	100 mm	110 mm	2,0 mm
9LASR110	110 mm	120 mm	3,0 mm
9LASR120	120 mm	130 mm	3,0 mm
9LASR125	125 mm	130 mm	3,0 mm
9LASR140	140 mm	135 mm	3,0 mm
9LASR150	150 mm	140 mm	3,0 mm
9LASR153	153 mm	140 mm	3,0 mm
9LASR200	200 mm	200 mm	3,0 mm



INOX DRAADFLENS

RVS 304 & RVS 316

Bestelnr	Maat	Flens PN	Steekcircel
9ZFGF12	DN15 x 1/2"	10/16	65 mm
9ZFGF34	DN20 x 3/4"	10/16	75 mm
9ZFGF1	DN25 x 1"	10/16	85 mm
9ZFGF54	DN32 x 5/4"	10/16	100 mm
9ZFGF64	DN40 x 6/4"	10/16	110 mm
9ZFGF2	DN50 x 2"	10/16	125 mm
9ZFGF25	DN65 x 2 1/2"	10/16	145 mm
9ZFGF3	DN80 x 3"	10/16	160 mm
9ZFGF4	DN100 x 4"	10/16	180 mm



INOX VOORLASFLENS

RVS 304 & RVS 316

Bestelnr	Maat DN	Maat inch	Flens	Steekcircel
9ZFVL015021316304	DN15 x 21,3mm	1/2"	16	65mm
9ZFVL020026916304	DN20 x 26,9mm	3/4"	16	75mm
9ZFVL025033716304	DN25 x 33,7mm	1"	16	85mm
9ZFVL032042416316	DN32 x 42,4mm	5/4"	16	100mm
9ZFVL040048316304	DN40 x 48,3mm	6/4"	16	110mm
9ZFVL050060316304	DN50 x 60,3mm	2"	16	125mm
9ZFVL065076116304	DN65 x 76,1mm	2 1/2"	16	145mm
9ZFVL080088916304	DN80 x 88,9mm	3"	16	160mm
9ZFVL100114316304	DN100 x 114,3mm	4"	16	180mm
9ZFVL125139716304	DN125 x 139,7mm	5"	16	210mm
9ZFVL150168316304	DN150 x 168,3mm	6"	16	240mm
9ZFVL200219110304	DN200 x 219,1 mm	8"	16	295mm
9ZFVL250273016304	DN250 x 273,0mm	10"	16	355mm



Meer info over flensafmetingen? Zie p106.

RVS DRAAD- & LASFITTINGEN

RVS FLENZEN



INOX VLAKKE FLENS

RVS 304 & RVS 316

Bestelnr	Maat DN	Maat	Flens PN	Steekcirkel
9ZFVF015021316304	DN15 x 21,3mm	1/2"	10/16	65 mm
9ZFVF020026916304	DN20 x 26,9mm	3/4"	10/16	75 mm
9ZFVF025033716304	DN25 x 33,7mm	1"	10/16	85 mm
9ZFVF032042416304	DN32 x 42,4mm	5/4"	10/16	100 mm
9ZFVF040048316304	DN40 x 48,3mm	6/4"	10/16	110 mm
9ZFVF050060316304	DN50 x 60,3mm	2"	10/16	125mm
9ZFVF065076116304	DN65 x 76,1mm	2 1/2"	10/16	145mm
9ZFVF080088916304	DN80 x 88,9mm	3"	10/16	160mm
9ZFVF100114316304	DN100 x 114,3mm	4"	10/16	180mm
9ZFVF125139716304	DN125 x 139,7mm	5"	10/16	210mm
9ZFVF150168316304	DN150 x 168,3mm	6"	10/16	240mm
9ZFVF200219110304	DN200 x 219,1mm	8"	10/16	295mm
9ZFVF250273010304	DN250 x 273,0mm	10"	16	355mm



INOX BLINDFLENS

RVS 304

Bestelnr	Maat DN	Maat inch	Flens PN	Steekcirkel
9ZFBF02516304	DN25	1"	40	85 mm
9ZFBF03216304	DN32	5/4"	40	100 mm
9ZFBF04016304	DN40	6/4"	40	110 mm
9ZFBF05016304	DN50	2"	16	125 mm
9ZFBF06516304	DN65	2 1/2"	16	145 mm
9ZFBF08016304	DN80	3"	16	160 mm
9ZFBF10016304	DN100	4"	16	180 mm
9ZFBF12516304	DN125	5"	16	210 mm
9ZFBF15016304	DN150	6"	16	240 mm
9ZFBF20016304	DN200	8"	16	295 mm

RVS DRAAD- & LASFITTINGEN



INOX BLINDFLENS

RVS 316

Bestelnr	Maat DN	Maat inch	Flens PN	Steekcirkel
9ZFBF02516316	DN25	1"	40	85 mm
9ZFBF03216316	DN32	5/4"	40	100 mm
9ZFBF04016316	DN40	6/4"	40	110 mm
9ZFBF0506316	DN50	2"	16	125 mm
9ZFBF06516316	DN65	2 1/2"	16	145 mm
9ZFBF08016316	DN80	3"	16	160 mm
9ZFBF10016316	DN100	4"	16	180 mm
9ZFBF12516316	DN125	5"	16	210 mm
9ZFBF15016316	DN150	6"	16	240 mm
9ZFBF20016316	DN200	8"	16	295 mm



INOX BOORDRING

RVS 304 & RVS 316

Bestelnr	Buismaat	Wanddikte
9LABR0172	17,2 mm	2,0 mm
9LABR0213	21,3 mm	2,0 mm
9LABR0240	24,0 mm	2,0 mm
9LABR0269	26,9 mm	2,0 mm
9LABR0280	28,0 mm	2,0 mm
9LABR0337	33,7 mm	2,0 mm
9LABR0424	42,4 mm	2,0 mm
9LABR0445	44,5 mm	2,0 mm
9LABR0483	48,3 mm	2,0 mm
9LABR0540	54,0 mm	2,0 mm
9LABR0603	60,3 mm	2,0 mm
9LABR0700	70,0 mm	2,0 mm
9LABR0761	76,1 mm	2,0 mm
9LABR0841	84,1 mm	2,0 mm
9LABR0889	88,9 mm	2,0 mm
9LABR1040	104,0 mm	3,0 mm
9LABR1060	106,0 mm	2,0 mm
9LABR1143	114,3 mm	3,0 mm
9LABR1290	129,0 mm	2,0 mm
9LABR1310	131,0 mm	2,0 mm
9LABR1397	139,7 mm	2,0 mm
9LABR15404	154,0 mm	2,0 mm
9LABR15406	154,0 mm	2,0 mm
9LABR1560	156,0 mm	3,0 mm
9LABR1683	168,3 mm	2,0 mm
9LABR20404	204,0 mm	2,0 mm
9LABR20406	204,0 mm	2,0 mm
9LABR2060	206,0 mm	2,0 mm
9LABR2191	219,1 mm	2,0 mm
9LABR2540	254,0 mm	3,0 mm
9LABR2560	256,0 mm	2,0 mm
9LABR2731	273,1 mm	2,0 mm
9LABR3040	304,0 mm	3,0 mm
9LABR3060	306,0 mm	3,0 mm
9LABR3239	323,9 mm	3,0 mm
9LABR3540	354,0 mm	3,0 mm
9LABR3560	356,0 mm	3,0 mm
9LABR4060	406,0 mm	3,0 mm
9LABR4560	456,0 mm	3,0 mm
9LABR5080	508,0 mm	3,0 mm

ALU OVERSCHUIFFLENS

ALUMINIUM

Bestelnr	Maat DN	Gatmaat	Flens PN	Steekcirkel
FLALU010	DN10	19 mm	10	60 mm
FLALU015	DN15	24 mm	10	65 mm
FLALU020	DN20	30 mm	10	75 mm
FLALU025	DN25	36 mm	10	85 mm
FLALU032	DN32	46 mm	10	100 mm
FLALU040	DN40	54 mm	10	110 mm
FLALU050	DN50	65 mm	10	125 mm
FLALU065	DN65	81 mm	10	145 mm
FLALU080	DN80	94 mm	10	160 mm
FLALU100	DN100	119 mm	10	180 mm
FLALU125	DN125	139 mm	10	210 mm
FLALU139	DN125	144 mm	10	210 mm
FLALU150	DN150	168 mm	10	240 mm
FLALU168	DN150	173 mm	10	240 mm
FLALU200	DN200	225 mm	10	295 mm
FLALU250	DN250	279 mm	10	350 mm
FLALU300	DN300	329 mm	10	400 mm
FLALU350	DN350	362 mm	10	460 mm
FLALU400	DN400	413 mm	10	515 mm
FLALU500	DN500	517 mm	10	620 mm
FLALU600	DN600	618 mm	10	725 mm
FLALU700	DN700	721 mm	10	840 mm
FLALU800	DN800	824 mm	10	950 mm



Meer info over flensafmetingen? Zie p106.

NOTITIES

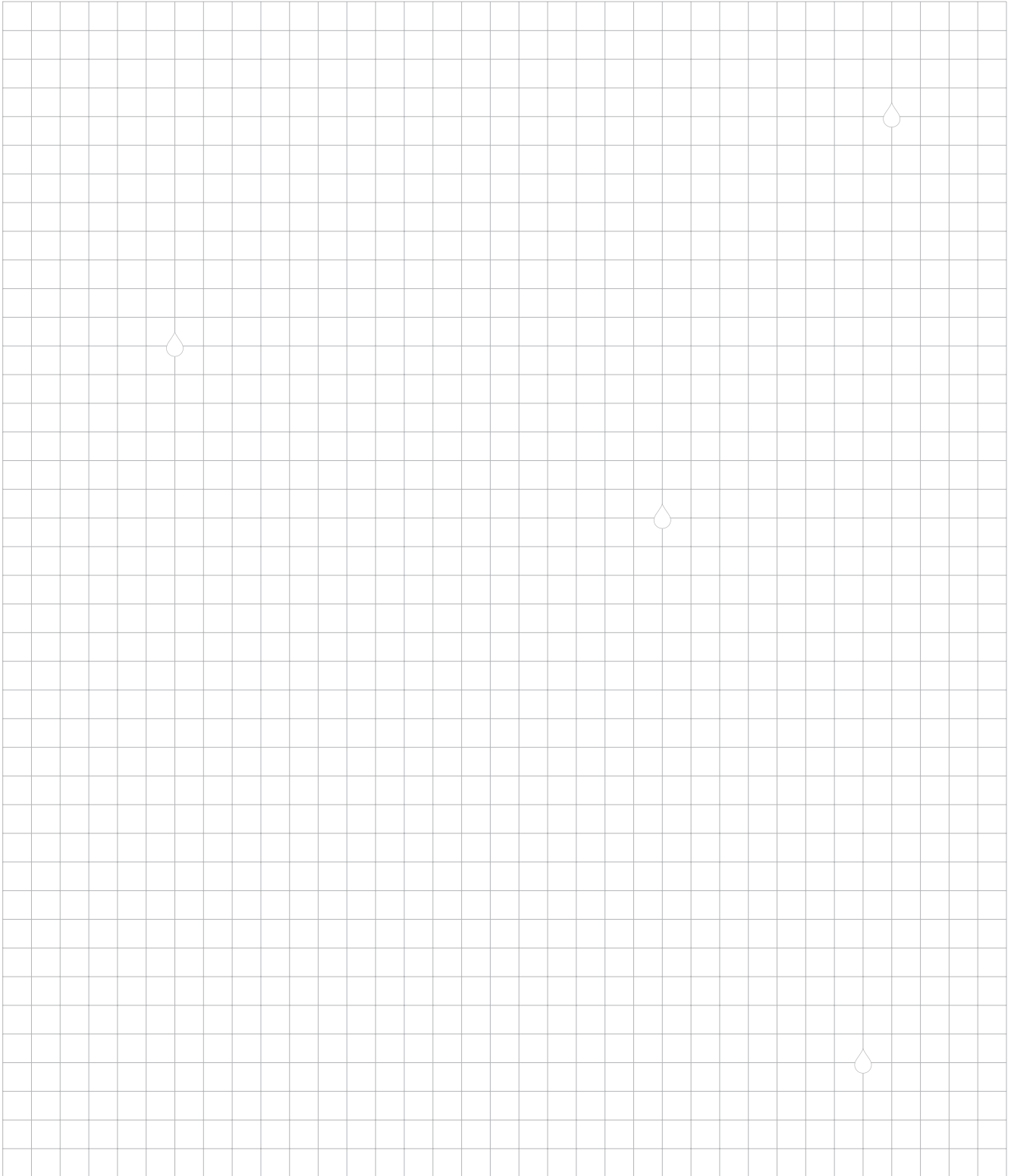

— DEEL 5 —

TECHNISCHE INFO



Draad inch	Draad mm	Kern mm	Spoel per 1"
1/8"	9,728	8,566	28
1/4"	13,157	11,445	19
3/8"	16,662	14,95	19
1/2"	20,955	18,631	14
5/8"	22,911	20,587	14
3/4"	26,441	24,117	14
1"	33,249	30,291	11
1 1/4"	41,91	38,952	11
1 1/2"	47,803	44,845	11
2"	59,614	56,656	11
2 1/2"	75,184	72,226	11
3"	87,884	84,926	11
4"	113,03	110,072	11

Maat "	Maximum Buitendiameter		Minimum Buitendiameter		Maat DN
	inch	mm	inch	mm	
1/8	0,417	10,6	0,386	9,8	6
1/4	0,551	14,0	0,520	13,2	8
3/8	0,689	17,5	0,657	16,7	10
1/2	0,858	21,8	0,827	16,7	15
3/4	1,075	27,3	1,043	26,5	20
1	1,346	34,2	1,311	33,3	25
1 1/4	1,689	42,9	1,654	42,9	32
1 1/2	1,921	48,8	1,886	47,9	40
2	2,394	60,8	2,350	59,7	50
2 1/2	3,016	76,6	2,965	75,3	65
3	3,524	89,5	3,465	88,0	80
3 1/2	4,020	102,1	3,953	100,4	90
4	4,528	115,0	4,453	113,1	100
5	5,543	140,8	5,453	138,5	125
6	6,555	166,5	6,453	163,9	150

Aansluitmaten

DN	6	8	10	15	20	25	32	40	50	65	80	100
"	1/8	1/4	3/8	1/2	3/4	1	1 1/4	1 1/2	2	2 1/2	3	4

TECHNISCHE INFO

FLENSAFMETINGEN

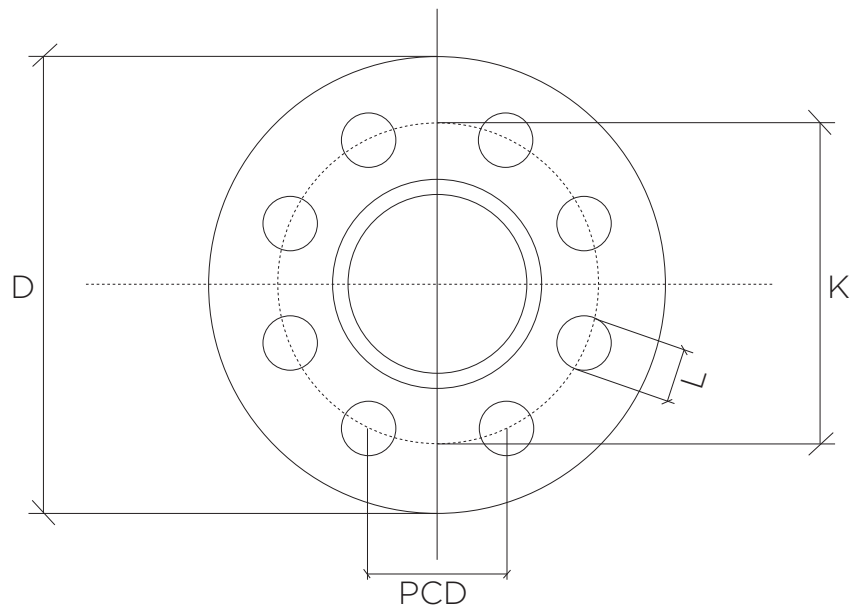

DN	ISO PN6					ISO PN10					ISO PN16					ISO PN25								
	EU-maten				Bouten		EU-maten				Bouten		EU-maten				Bouten		EU-maten				Bouten	
	D	K	L	PCD	#	Ø	D	K	L	PCD	#	Ø	D	K	L	PCD	#	Ø	D	K	L	PCD	#	Ø
10	75	50	11	36	4	M 10	90	60	14	43	4	M 12	90	60	14	43	4	M 12	90	60	14	43	4	M 12
15	80	55	11	39	4	M 10	95	65	14	46	4	M 12	95	65	14	46	4	M 12	95	65	14	46	4	M 12
20	90	65	11	46	4	M 10	105	75	14	53	4	M 12	105	75	14	53	4	M 12	105	75	14	53	4	M 12
25	100	75	11	53	4	M 10	115	85	14	60	4	M 12	115	85	14	60	4	M 12	115	85	14	60	4	M 12
32	120	90	14	64	4	M 12	140	100	19	71	4	M 16	140	100	19	71	4	M 16	140	100	19	71	4	M 16
40	130	100	14	71	4	M 12	150	110	19	78	4	M 16	150	110	19	78	4	M 16	150	110	19	78	4	M 16
50	140	110	14	78	4	M 12	165	125	19	89	4	M 16	165	125	19	89	4	M 16	165	125	19	89	4	M 16
65	160	130	14	92	4	M 12	185	145	19	103	4	M 16	185	145	19	103	4	M 16	185	145	19	55	8	M 16
80	190	150	18	107	4	M 16	200	160	19	61	8	M 16	200	160	19	61	8	M 16	200	160	19	61	8	M 16
100	210	170	18	121	4	M 16	220	180	19	68	8	M 16	220	180	19	68	8	M 16	235	190	23	72	8	M 20
125	240	200	18	76	8	M 16	250	210	19	80	8	M 16	250	210	19	80	8	M 16	270	220	28	84	8	M 24
150	265	225	18	86	8	M 16	285	240	23	91	8	M 20	285	240	23	91	8	M 20	300	250	28	95	8	M 24
200	320	280	18	106	8	M 16	340	295	23	112	8	M 20	340	295	23	74	12	M 20	360	310	28	78	12	M 24
250	375	335	18	84	12	M 16	395	350	23	88	12	M 20	405	355	28	89	12	M 24	425	370	31	93	12	M 27
300	440	395	22	99	12	M 20	445	400	23	100	12	M 20	460	410	28	103	12	M 24	485	430	31	82	16	M 27
350	490	445	22	111	12	M 20	505	460	23	87	16	M 20	520	470	28	89	16	M 24	555	490	34	93	16	M 30
400	540	495	22	94	16	M 20	565	515	28	98	16	M 24	580	525	31	100	16	M 27	620	550	37	105	16	M 33
450	595	550	22	105	16	M 20	615	565	28	90	20	M 24	640	585	31	94	20	M 27	670	600	37	96	20	M 33
500	645	600	22	96	20	M 20	670	620	28	99	20	M 24	715	650	34	104	20	M 30	730	660	37	106	20	M 33
600	755	705	26	113	20	M 24	780	725	31	116	20	M 27	840	770	37	123	20	M 33	845	770	41	123	20	M 36
700	860	810	26	105	24	M 24	895	840	31	109	24	M 27	910	840	37	109	24	M 33	960	875	44	114	24	M 39
800	975	920	30	120	24	M 27	1015	950	34	124	24	M 30	1025	950	41	124	24	M 36	1085	990	50	129	24	M 45
900	1075	1020	30	133	24	M 27	1115	1050	34	116	28	M 30	1125	1050	41	116	28	M 36	1185	1090	50	120	28	M 45
1000	1175	1120	30	123	28	M 27	1230	1160	37	128	28	M 33	1255	1170	44	129	28	M 39	1320	1210	57	133	28	M 52

DN	ISO PN40						ISO PN20 - ANSI 150						ISO PN50 - ANSI 300					
	EU-maten				Bouten		EU-maten				Bouten		EU-maten				Bouten	
	D	K	L	PCD	#	Ø	D	K	L	PCD	#	Ø	D	K	L	PCD	#	Ø
10	90	60	14	43	4	M 12												
15	95	65	14	46	4	M 12	88,9	60,5	15,8	43	4	M 14	95,3	66,5	15,8	47	4	M 14
20	105	75	14	53	4	M 12	98,6	69,9	15,8	50	4	M 14	117,4	88,6	19,0	63	4	M 16
25	115	85	14	60	4	M 12	108,0	79,4	15,8	56	4	M 14	124,0	88,9	19,0	63	4	M 16
32	140	100	19	71	4	M 16	117,0	88,9	15,8	63	4	M 14	133,0	98,4	19,0	70	4	M 16
40	150	110	19	78	4	M 16	127,0	98,4	15,8	70	4	M 14	156,0	114,3	22,2	81	4	M 20
50	165	125	19	89	4	M 16	152,0	120,4	19,0	85	4	M 16	165,0	127,0	22,2	48	8	M 20
65	185	145	19	55	8	M 16	178,0	139,7	19,0	99	4	M 16	190,0	149,2	22,2	57	8	M 20
80	200	160	19	61	8	M 16	190,0	152,4	19,0	108	4	M 16	210,0	168,3	22,2	64	8	M 20
100	235	190	23	72	8	M 20	229,0	190,5	19,0	72	8	M 16	254,0	200,0	22,2	76	8	M 20
125	270	220	28	84	8	M 24	254,0	215,9	22,2	82	8	M 20	279,0	235,0	22,2	89	8	M 20
150	300	250	28	95	8	M 24	279,0	241,3	22,2	92	8	M 20	318,0	269,9	22,2	70	12	M 20
200	375	320	31	83	12	M 27	343,0	298,4	22,2	113	8	M 20	381,0	330,2	25,4	86	12	M 24
250	450	385	34	100	12	M 30	406,0	362,0	25,4	94	12	M 24	444,0	387,4	28,5	74	16	M 27
300	515	450	34	86	16	M 30	483,0	431,8	25,4	112	12	M 24	521,0	450,8	31,8	86	16	M 30
350	580	510	37	97	16	M 33	533,0	476,2	28,5	124	12	M 27	584,0	514,4	31,8	82	20	M 30
400	660	585	41	111	16	M 36	597,0	539,8	28,5	103	16	M 27	648,0	571,5	35,0	91	20	M 33
450	685	610	41	98	20	M 36	635,0	577,8	31,8	110	16	M 30	711,0	628,6	35,0	82	24	M 33
500	755	670	43	107	20	M 39	698,0	635,0	31,8	102	20	M 30	775,0	685,8	35,0	89	24	M 33
600	890	795	49	127	20	M 45	813,0	749,3	35,0	120	20	M 33	914,0	812,8	41,1	106	24	M 39

Algemene informatie

De voorgestelde producten in deze catalogus, informatie betreffende uitvoering, prestaties en afmetingen stemmen overeen met de situatie op het ogenblik van druk. Wij behouden het recht op wijzigingen zonder voorafgaande verwittiging.

Kopiëren of reproductie in welke vorm dan ook, zelfs gedeeltelijk, is niet toegestaan zonder schriftelijke toestemming van Dema-shop bv, Ovenstraat 11, 8800 Roeselare.

Voor meer informatie over al onze producten bezoek dan www.demashop.be



Dema-shop bv

Ovenstraat 11
8800 Roeselare

Openingsuren

ma-vr 8u-12u & 13u-18u
za 8u-12u



+32 (0)51 20 51 41



+32 (0)51 23 29 19



info@demashop.be

Prijzen

Al onze prijzen zijn in Euro en exclusief BTW.

Bestellingen

Orders beneden een netto bedrag van € 50,- worden niet uitgeleverd.

Leveringen

- De prijzen voor levering zijn EX WORKS.
- De vrachtkosten zijn volgens het tarief van de expediteur.

Betaling

- Facturen zijn betaalbaar 30 dagen einde maand.
- Rembourszendingen worden na vooruitbetaling geleverd, bij betaling met cheque via expediteur wordt een toeslag van € 6,80,- aangerekend.
- Wij behouden ons de eigendom van de geleverde goederen tot de betaling van de volledige koopprijs.

Klachten

Klachten over leveringen en dergelijke worden alleen in behandeling genomen bij schriftelijke melding binnen de 8 dagen na levering via mail naar:
service@demashop.be

Wijzigingen

Wijzigingen in prijzen, illustraties, beschrijvingen en technische specificaties voorbehouden.



DEMA-SHOP bv

Ovenstraat 11
8800 Roeselare
Belgium

T +32(0)51 20 51 41

F +32(0)51 23 29 19

info@demashop.be

www.demashop.be

BEO426.954.705



versie 23.01.00