

*Where are we cooking today?*

**Workbook  
2022**



# Heritage

Born from a love of camping and outdoor living, coupled with a desire to always create and innovate, Campingaz® products are instinctive and inspired, simple yet clever solutions based on over 70 years of expertise.

Campingaz® stands for safe and reliable products that are made to stay with you. Be a part of our family!



1949  
Stoves



1970's  
Coolers



1980's  
Valve Cartridges



1990's  
Barbecues



2010's  
Xcelerate™ Stoves





# It's the simple things that count...



Often simple thoughts spark big ideas; in 1949, when a young man embarked on a camping holiday with his family, he could never have anticipated that his thoughts that day would change the way in which people camped for generations to come.

Frustrated by the alternatives available, he set about creating a revolutionary refillable cylinder; compact and convenient, economic and easy to use. The Campingaz® brand was born...and life outdoors was liberated.

From the beach to the campsite, or from the garden to the hills, Campingaz® innovations have changed the blueprint for outdoor cooking and adventure, each decade introducing revolutionary innovations.

With over 70 years as a leader in outdoor gas and gas appliances and 70 years experience as the Outdoor Cooking Expert™, Campingaz has created reliable products that also form lasting memories.

2012 Planchas	2014 Barbecue Relaunch	2017 Master Series	2021 New Barbecue Range
			



# *The simple pleasures are the best.*

**The flavour of food cooked outdoors. The warm glow of evenings by lantern light. These are the moments, the memories and the feelings that inspire us at Campingaz<sup>®</sup>, and have done for over 70 years.**

Since 1949 we've enhanced people's experience of the outdoors, becoming part of their life. We continue to innovate and inspire our versatile products that suit all your outdoor needs or wherever your adventurous spirit takes you. All our products are designed with one aim in mind: to make outdoor freedom accessible to everyone.

Today we still believe in that combination of practicality and inspiration – whether in your own back garden, on a beach or camping far from home. We continue to innovate because we know there are always smarter ways to do things, but we retain the classic solutions you know and love.



<b>Barbecues and Planchas</b>	<b>4</b>
<b>Barbecue Accessories</b>	<b>58</b>
<b>Cylinders and Cartridges</b>	<b>70</b>
<b>Food Preparation</b>	<b>80</b>
<b>Coolers</b>	<b>104</b>
<b>Lanterns</b>	<b>128</b>
<b>Airbeds and Pumps</b>	<b>135</b>
<b>Help Section</b>	<b>139</b>
<b>Legal</b>	<b>144</b>





# Barbecues & Planchas

Smart technology embedded in appealing designs. Our extensive range of barbecues features the perfect model for every consumer.









# Our Barbecue Range

The Campinggaz® BBQ range offers a wide selection of barbecues. Every enthusiastic sizzler, from the barbecue novice to the passionate gourmet griller, will find the perfect barbecue within the Campinggaz® assortment.

## 4 SERIES

---

Perfect for big families and hosting friends. Guaranteeing significantly less flare-ups, perfectly even heat distribution, stylish exterior and the revolutionary Campinggaz InstaClean™ Aqua system, the new 4 Series is packed with benefits so you will want to barbecue all the time.



4 Series Onyx S



4 Series Premium S



4 Series Select S

## 3 SERIES

---

These barbecues boast spacious cooking areas, the powerful Blue Flame Power System and the Campinggaz InstaClean™ Aqua cleaning system. Ideal for families and garden parties.



3 Series Premium S



3 Series Select S

## CLASSIC SERIES

---

Tried and tested, our Classic Series barbecues bring down-to-earth grilling pleasures to each and everyone.



4 Series Classic LS  
Plus Black



4 Series Classic LS  
Black



3 Series Classic LS  
Plus Black



3 Series Classic LS  
Black

## 2 SERIES

---

Great performance for folks with smaller backyards.



2 Series Classic EXS  
Vario Black



2 Series Classic LX  
Plus Black



## XPERT

---

The Campingaz® XPERT range delivers quality performance in its class. Ideal for beginners and people looking to use smaller spaces.



**Xpert 100 L**

## ATTITUDE

---

The Campingaz® Attitude Series of table top barbecues pairs sleek, urban styling with pioneering precision cooking, all within a compact, portable package.



**Attitude 2100 EX**



**Attitude 2100 LX**



**Attitude 2go CV Grey**



**Attitude 2 Go**

## PLANCHA

---

Plancha cooking for utmost versatility in food preparation outdoors.



**Plancha Blue Flame LX**



**Plancha L**



**Plancha Trolley Deluxe**



The background image shows a woman with curly blonde hair, wearing a white t-shirt, smiling and looking towards the right. She is standing on a wooden deck. In the foreground, a barbecue grill is visible with a skewer of food cooking on it. Other people are partially visible in the background, including a woman with dark hair and another person with a tattoo on their arm. The setting is outdoors with trees and a grassy area in the background.

## SERIES BARBECUES

Cook up a feast for family and friends with our brand new barbecues. Featuring efficient and high-performance stainless steel burners with our efficient Blue Flame Power System that ensures significantly less flare-ups by design and keeps your food nice and juicy. Together with a large, enamelled cooking surface these barbecues are perfect for preparing a wide range of al fresco meals. The included Campingaz® Culinary Modular System provides keen grillers with even greater cooking versatility. Cleaning is quick and hassle-free thanks to the Campingaz InstaClean™ Aqua System. Our Campingaz® Series Barbecue range make for the perfect companion: Either for hungry families as a 4 Burner or for everyone who loves high quality barbecue as a space efficient 3 Burner.







## BLUE FLAME POWER SYSTEM



**Significantly less flare-ups by design!**

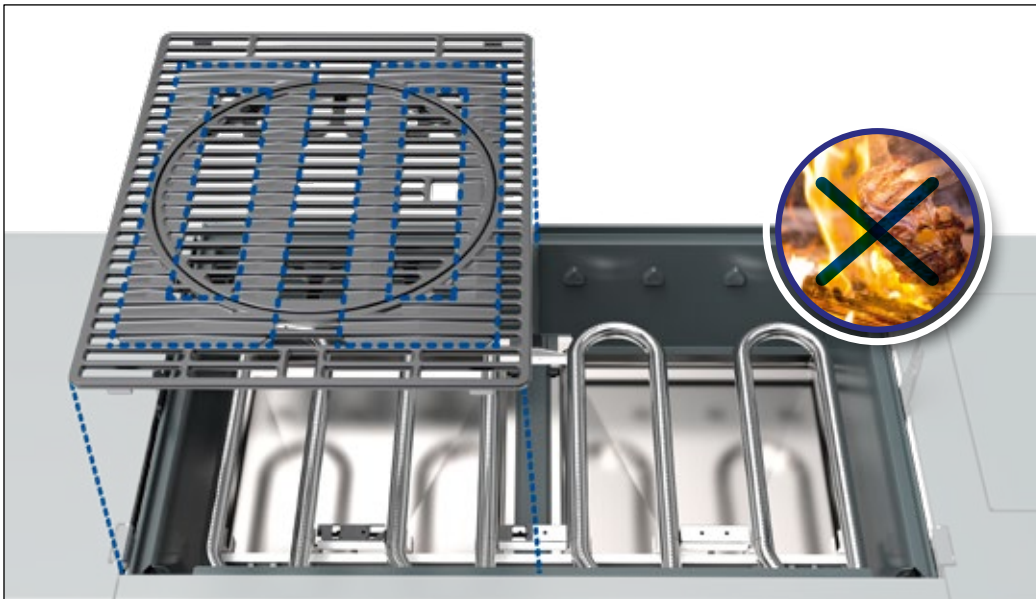

The Blue Flame power system by Campingaz® offers accelerated pre-heating, optimal heat distribution and significantly less flare-ups by design.

The distinctive shaped burner cleverly distributes flames under the entire grilling surface offering a perfectly even heat distribution. The burner protection is integrated into the cast iron grids removing the burner protection layer below the cooking surface. Hot grease and juices are thereby prevented from collecting and causing dangerous flames in the fire box. Water from the InstaClean™ Aqua further assists in keeping undesirable combustion in check.

The stainless steel burners of the Blue Flame power system come with a 5 year warranty.

The improved Campingaz® Blue Flame power system; durable, powerful and efficient burners for the perfect sizzle!

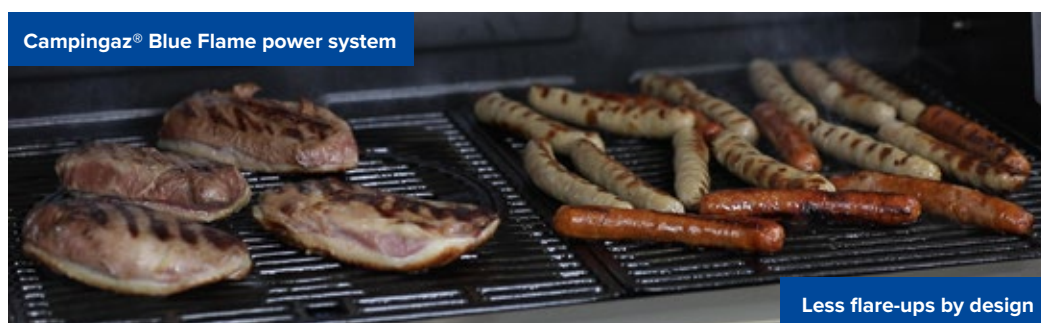

Campingaz® Blue Flame power system

Less flare-ups by design



Keep it juicy  
AND crispy!





## INSTACLEAN™ AQUA SYSTEM



# No more scrubbing!



### Effortless cleaning thanks to InstaClean™ Aqua System.

We love to grill – but cleaning is always a pain. Good news: Our Campinggaz® InstaClean system just got even better.

Integrated in our Series barbecues, the clever and effortless Campinggaz® InstaClean Aqua technology harnesses the power of water to make cleaning a piece of cake.

Water is filled into the front-loading grease drawers, preventing all residual grease and food waste, from baking into the material. Similarly, the small amount of resulting evaporation during your grilling session, also works as a grease repellent, preventing grease and grime from burning into the firebox materials. When it's time to clean, thanks to this clever system, you can remove the greasy grill parts and simply wash them off. No scrubbing required!

The waste water in the grease drawer can simply be drained by removing a plug. Premium and Onyx models come fitted with a waste water container including a removable filter to separate dense grease, making waste water disposal even more convenient.

Quick, effortless and squeaky clean!





## CAMPINGGAZ® CULINARY MODULARS



**Unleash your grilling creativity with prolonged cooking versatility**



**Extend your kitchen outdoors with Campingaz® interchangeable cooking solutions!**

Simply take out the inner ring of the cast iron modular, or remove/reverse the adjacent griddle and insert one of the various Campingaz® Culinary Modular Barbecue Accessories. (items sold separately)

The Campingaz® Culinary Modulares offer every option your gourmet barbecue heart desires.

Culinary Modular System integrated in all Campingaz Master, Onyx, Premium and Select models. System integration can vary on Classic range.





## 4 SERIES

### 4 Series Onyx S

2000037288



Reversible, enamelled cast iron griddle

**InstaStart™** intuitive one-touch ignition with illuminated safety controls

**Supports up to 13kg gas bottles** within a fully enclosed trolley with streamlined design and integrated bodykit wheel chassis

**All-Terrain caster wheels** with brakes offer easy mobility across all surfaces and a secure stance

**Powerful side burner** for preparing sauces or boiling other side dishes

**Improved storage solution** with Campingaz Push2Fold folding side tables

**5 year warranty** on the Campingaz® Blue Flame Power System and cooking surfaces

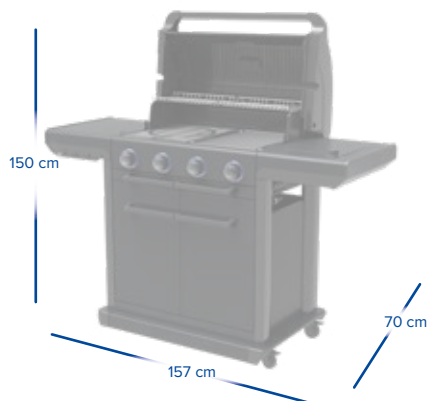



## 4 Series Premium S

2000037286



Reversible, enamelled cast iron griddle



**Electric ignition** offers convenient lighting with batteries that are included

**Supports up to 13kg gas bottles** within a partly enclosed trolley with doors

**Swivel castors** with brakes offer convenient mobility and manoeuvrability

**Improved storage solution** with Campinggaz Push2Fold folding side tables

**Integrated utensil hooks** for easy access and convenient storage of grilling accessories

**5 year warranty** on the Campinggaz® Blue Flame Power System and cooking surfaces

Also available in Midnight Black

## 4 Series Select S

2000037482



Reversible, enamelled cast iron griddle



**Electric ignition** offers convenient lighting with batteries that are included

Front panel chassis with **integrated spice rack**, also offering dedicated hold offering **support for up to 13 kg gas bottles**

**Robust turf wheels** offer optimised durability and reliable mobility across all surfaces

**Powerful side burner** for preparing sauces or boiling other side dishes

**2x warming racks** that can be removed easily and independently offer increased versatility for convection grilling

**5 year warranty** on the Campinggaz® Blue Flame Power System and cooking surfaces

Also available in Midnight Black

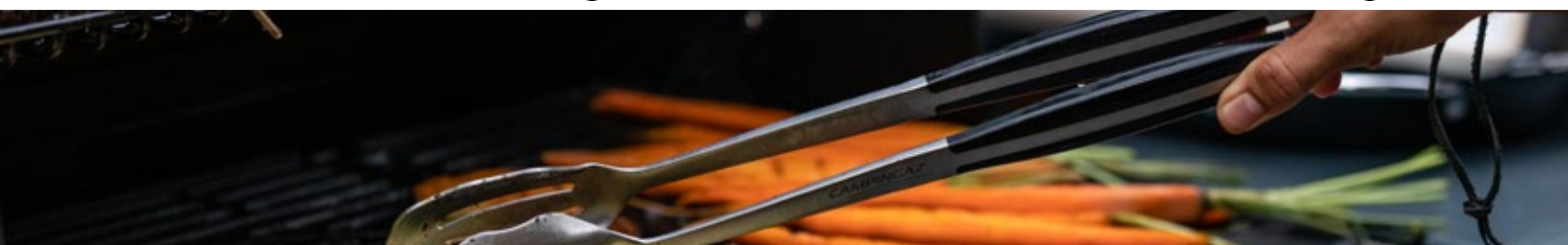

Campinggaz® Blue Flame Burners



Campinggaz InstaClean™ Aqua System



Campinggaz® Culinary Modulars



Campinggaz® Push2Fold side tables



Significantly less flare-ups by design





## 4 SERIES



	<b>4 Series Onyx S</b>	<b>4 Series Premium S</b>	<b>4 Series Select S</b>
<b>SKU</b>	<b>2000037288</b>	<b>2000037286</b>	<b>2000037482</b>
<b>EAN</b>	3138522119294	3138522119270	3138522119249
<b>Cooking Surface (cm<sup>2</sup>)</b>	3312	3312	3312
<b>Cooking Dimensions (cm)</b>	46 x 72	46 x 72	46 x 72
<b>Burner Technology</b>	Blue Flame Power System in stainless steel	Blue Flame Power System in stainless steel	Blue Flame Power System in stainless steel
<b>No of burners</b>	4	4	4
<b>Power (kW) breakdown</b>	13.6 + 2.3	13.6 + 2.3	13.6 + 2.3
<b>Gas consumption total (g/h)</b>	1155	1155	1155
<b>Gas consumption breakdown</b>	247 g/h + 167g/h	247 g/h + 167g/h	247 g/h + 167g/h
<b>Cleaning System</b>	InstaClean™ Aqua Pro with grease drawers accessible from the front and integrated grease evacuation cups with filter in each door	InstaClean™ Aqua Pro with grease drawers accessible from the front and integrated grease evacuation cups with filter in each door	InstaClean™ Aqua Basic with grease drawers accessible from the front
<b>Material</b>	Porcelain enamelled cast iron	Porcelain enamelled cast iron	Porcelain enamelled cast iron
<b>Configuration</b>	Grid + Rev. Griddle	Grid + Rev. Griddle	Grid + Grid
<b>Culinary Modular System</b>	Yes	Yes	Yes
<b>Warming Rack</b>	(2) 17 x 35 cm	(2) 17 x 35 cm	(2) 17 x 35 cm
<b>Rotisserie Option</b>	Yes	Yes	Yes
<b>Cooking Height</b>	95 cm	93 cm	92 cm
<b>Ignition</b>	InstaStart™	Electronic	Electronic
<b>Thermometer</b>	Yes	Yes	Yes
<b>Foldable side table(s)</b>	Left side-table foldable	Left side-table foldable	Left side-table foldable
<b>Side burner</b>	Yes	Yes	Yes
<b>Lid Material</b>	painted steel + painted aluminium	painted steel + painted aluminium	painted steel + painted aluminium
<b>Trolley Material</b>	painted steel	painted steel	painted steel
<b>Trolley chassis configuration</b>	Doors closed sides closed back	Doors closed sides open back	Front panel open sides open back
<b>Number and type of Wheels</b>	4x all terrain master castors	4x swivel castors	2x durable turf wheels
<b>Maximum gas bottle capacity (without safety cap)</b>	60cm	60cm	60cm
<b>Weight kg</b>	73	70	64
<b>Dimensions (W x D x H) in cm (open)</b>	157 x 70 x 150	157 x 69 x 148	157 x 70 x 148
<b>Dimensions (W x D x H) in cm (closed)</b>	135 x 64 x 121	135 x 60 x 119	135 x 64 x 119
<b>Warranty</b>	5 years on lid 5 years on burner 5 years on cooking surfaces	5 years on lid 5 years on burner 5 years on cooking surfaces	5 years on lid 5 years on burner 5 years on cooking surfaces
<b>Optional cover</b>	Premium Barbecue Cover XL (2000037292)	Premium Barbecue Cover XL (2000037292)	Premium Barbecue Cover XL (2000037292)



## SUGGESTED ACCESSORIES



**Premium Barbecue Cover L**

2000037297  
See page 68



**Culinary Modular Pizza Stone and Pizza Cutter**

2000014582  
See page 62



**Culinary Modular Cast Iron Wok**

2000036961  
See page 63



**Culinary Modular Poultry Roaster**

2000014576  
See page 62



**Stainless Steel Tongs**

2000014567  
See page 65



**Triangular Cleaning Brush**

2000032369  
See page 67

## CAMPINGAZ® FEATURES\*



Powerful stainless steel Blue Flame Power System ensure perfectly even heat distribution, significantly less flare-ups and keeps your food juicy and crisp



5 year warranty on lid, stainless steel blue flame burners and on cast iron grids and griddles



Revolutionary Campingaz InstaClean™ Aqua ensures smart and effortless cleaning



Intuitive one-touch InstaStart™ ignition



Maximise your cooking and grilling options with the Campingaz® Culinary Modularity



Illuminated safety controls signify when the gas is on



Integrated grease evacuation container included on all InstaClean™ Aqua Pro models (number of containers included varies per model)



Significantly less flare-ups by design



Number of people that can be comfortably served per grilling session

\*Depending on model



## 3 SERIES

### 3 Series Premium S

2000037280



Reversible, enamelled cast iron griddle



**Electric ignition** offers convenient lighting with batteries that are included

**Supports up to 13kg gas bottles** within a partly enclosed trolley with doors

**Swivel castors** with brakes offer convenient mobility and manoeuvrability

**Improved storage solution** with Campinggaz Push2Fold folding side tables

**Integrated utensil hooks** for easy access and convenient storage of grilling accessories

**5 year warranty** on the Campinggaz® Blue Flame Power System and cooking surfaces

Also available in Midnight Black ●





## 3 Series Select S

2000037275



Reversible, enamelled cast iron griddle



**Electric ignition** offers convenient lighting with batteries that are included

Front panel chassis with **integrated spice rack**, also offering dedicated hold offering **support for up to 13 kg gas bottles**

**Robust turf wheels** offer optimised durability and reliable mobility across all surfaces

**Wooden side tables** with Campingaz Push2Fold folding side tables, round off the signature design and provide convenient storage functionality

**Large warming rack** offering increased versatility for convection grilling, can be removed easily when required

**5 year warranty** on the Campingaz® Blue Flame Power System and cooking surfaces

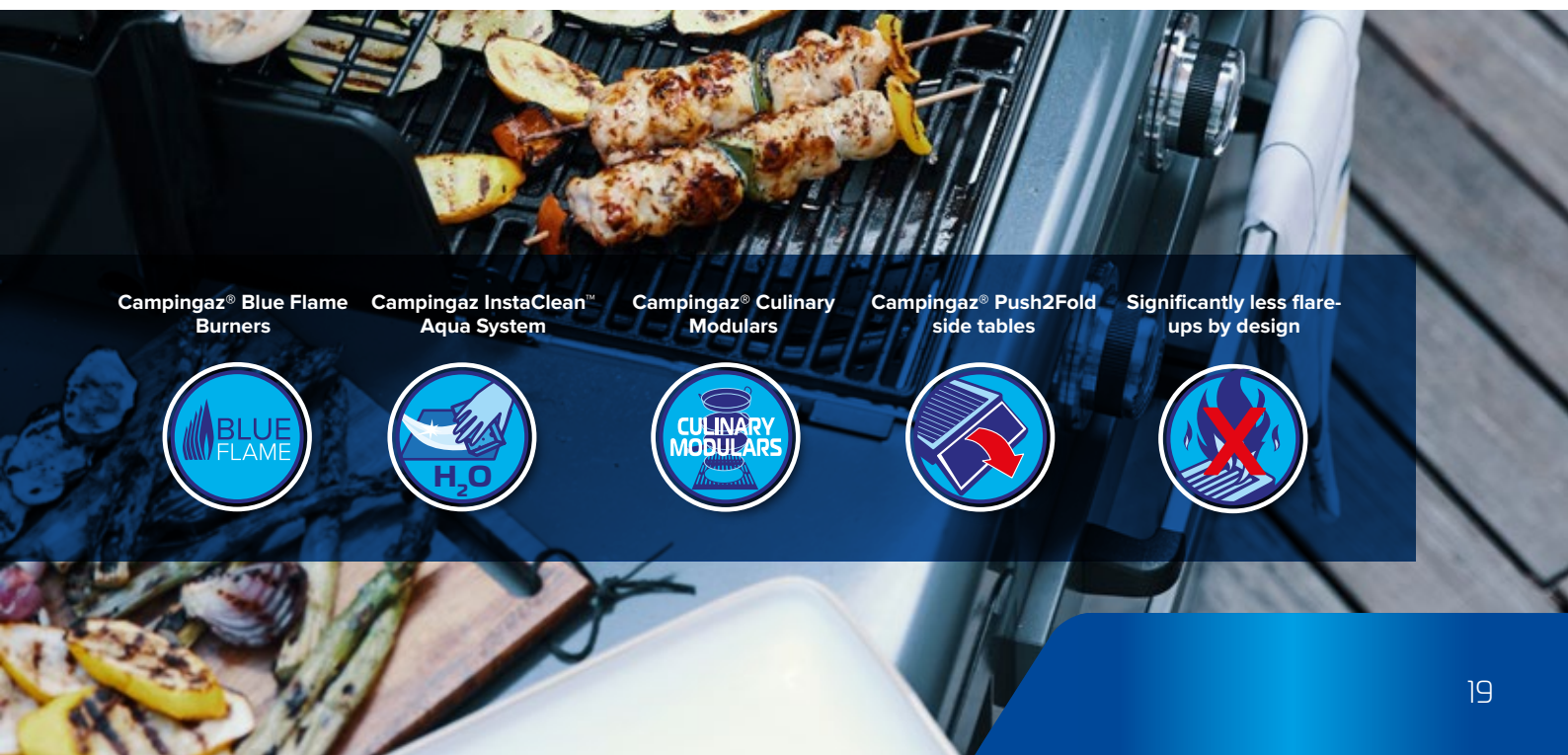

Campingaz® Blue Flame Burners



Campingaz InstaClean™ Aqua System



Campingaz® Culinary Modularity



Campingaz® Push2Fold side tables



Significantly less flare-ups by design





## 3 SERIES



	<b>3 Series Premium S</b>	<b>3 Series Select S</b>
<b>SKU</b>	<b>2000037280</b>	<b>2000037275</b>
<b>EAN</b>	3138522119218	3138522119164
<b>Cooking Surface (cm<sup>2</sup>)</b>	2806	2806
<b>Cooking Dimensions (cm)</b>	46 x 61	46 x 61
<b>Burner Technology</b>	Blue Flame Power System in stainless steel	Blue Flame Power System in stainless steel
<b>No of burners</b>	3	3
<b>Power (kW) breakdown</b>	10.2 + 2.3	10.2 + 2.3
<b>Gas consumption total (g/h)</b>	908	908
<b>Gas consumption breakdown</b>	247g/h + 167g/h	247 g/h + 167g/h
<b>Cleaning System</b>	InstaClean™ Aqua Pro with grease drawers accessible from the front and integrated water cup with filter in door	InstaClean™ Aqua Basic with grease drawers accessible from the front
<b>Material</b>	Porcelain enamelled cast iron	Porcelain enamelled cast iron
<b>Configuration</b>	Grid + Rev. Griddle	Grid + Grid
<b>Culinary Modular System</b>	Yes	Yes
<b>Warming Rack</b>	17 x 62 cm	17 x 62 cm
<b>Rotisserie Option</b>	Yes	Yes
<b>Cooking Height</b>	93 cm	92 cm
<b>Ignition</b>	Electronic	Piezo
<b>Thermometer</b>	Yes	Yes
<b>Foldable side table(s)</b>	Left side-table foldable	Left side-table foldable
<b>Side burner</b>	Yes	Yes
<b>Lid Material</b>	painted steel + painted aluminium	painted steel + painted aluminium
<b>Trolley Material</b>	painted steel	painted steel
<b>Trolley chassis configuration</b>	Doors closed sides closed back	Front panel open sides open back
<b>Number and type of Wheels</b>	4x swivel castors	2x durable turf wheels
<b>Maximum gas bottle capacity (without safety cap)</b>	60cm	60cm
<b>Weight kg</b>	66	59
<b>Dimensions (W x D x H) in cm (open)</b>	146 x 69 x 148	146 x 70 x 148
<b>Dimensions (W x D x H) in cm (closed)</b>	124 x 60 x 121	124 x 64 x 119
<b>Warranty</b>	5 years on lid 5 years on burner 5 years on cooking surfaces	5 years on lid 5 years on burner 5 years on cooking surfaces
<b>Optional cover</b>	Premium Barbecue Cover L (2000037291)	Premium Barbecue Cover L (2000037291)



## SUGGESTED ACCESSORIES



**Barbecue Cover L**  
2000037296  
See page 68



**Culinary Modular Pizza Stone and Pizza Cutter**  
2000014582  
See page 62



**Culinary Modular Wok**  
2000038449  
See page 62



**Culinary Modular Poultry Roaster**  
2000014576  
See page 62



**Stainless Steel Tong**  
2000014567  
See page 65



**Triangular Cleaning Brush**  
2000032369  
See page 67

## CAMPINGAZ® FEATURES\*



Powerful stainless steel Blue Flame Power System ensure perfectly even heat distribution, significantly less flare-ups and keeps your food juicy and crisp



Significantly less flare-ups by design



Revolutionary Campingaz InstaClean™ Aqua ensures smart and effortless cleaning



Integrated grease evacuation container included on all InstaClean™ Aqua Pro models



Maximise your cooking and grilling options with the Campingaz® Culinary Modularity



Number of people that can be comfortably served per grilling session



5 year warranty on stainless steel tube burners, providing strong performance and even heat

\*Depending on model



A photograph of a family of four (a woman, a man, and two children) sitting around a wooden picnic table outdoors. They are smiling and looking at each other. The woman is leaning over the table, and the man is holding a corn on the cob. The background shows a large tree and green foliage.

## CLASSIC SERIES

Cook up a feast for family and friends with our Classic Series barbecues. Featuring efficient and high-performance stainless steel tube burners together with a large, enamelled cooking surface these barbecues are perfect for preparing a wide range of al fresco meals. The included (EXS and LXS) or optional addition (LS and L) of The Campingaz® Culinary Modulares provide keen grillers with even greater cooking versatility. While the Even Temp™ Technology offers perfectly even heat distribution. Cleaning is quick and hassle-free thanks to the Campingaz InstaClean™ System.







## INSTACLEAN™ SYSTEM

---



**Discover the ease of BBQ cleaning**  
with the Campingaz InstaClean™ System

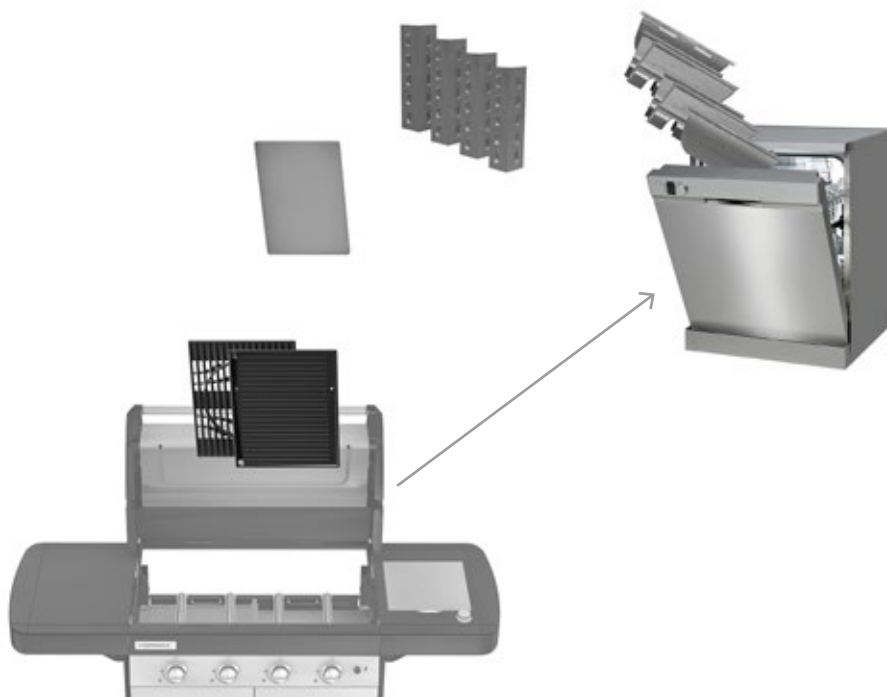

### **Quick and simple!** **Let your dishwasher do the work!**

The system allows you to remove all dishwasher safe parts in less than 60 seconds. The dishwasher will help remove remaining oil and grease.

All parts are designed to fit a standard dishwasher for even easier cleaning

This system is featured on 3 and 4 Series barbecues.

Now it's also available as an accessory - Renew your firebox !

The improved Campingaz InstaClean™ System is on all our Master Series barbecues.



## EVEN TEMP™ TECHNOLOGY

---

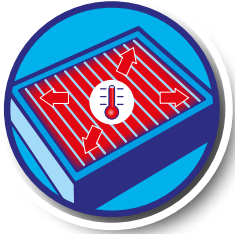

### Even Temp™ Technology Guarantees Even Heat Distribution



### Grill effectively and efficiently with our Even Temp™ Technology for perfectly even heat distribution

Campingaz® BBQs with Even Temp™ Technology cook your food evenly across the entire cooking surface of your barbecue.

Thanks to the patented Even Temp™ Technology, Campingaz® barbecues reach more than 250°C on the cooking surface.

This system is featured on all Master Series, RBS™ Series, 4 & 3 Series, Attitude Barbecues, and Master Plancha and Blue Flame Planchas





# CAMPINGGAZ® CULINARY MODULARS



**Versatile cooking and grilling options** are quick and convenient with Campingaz® Culinary Modulares

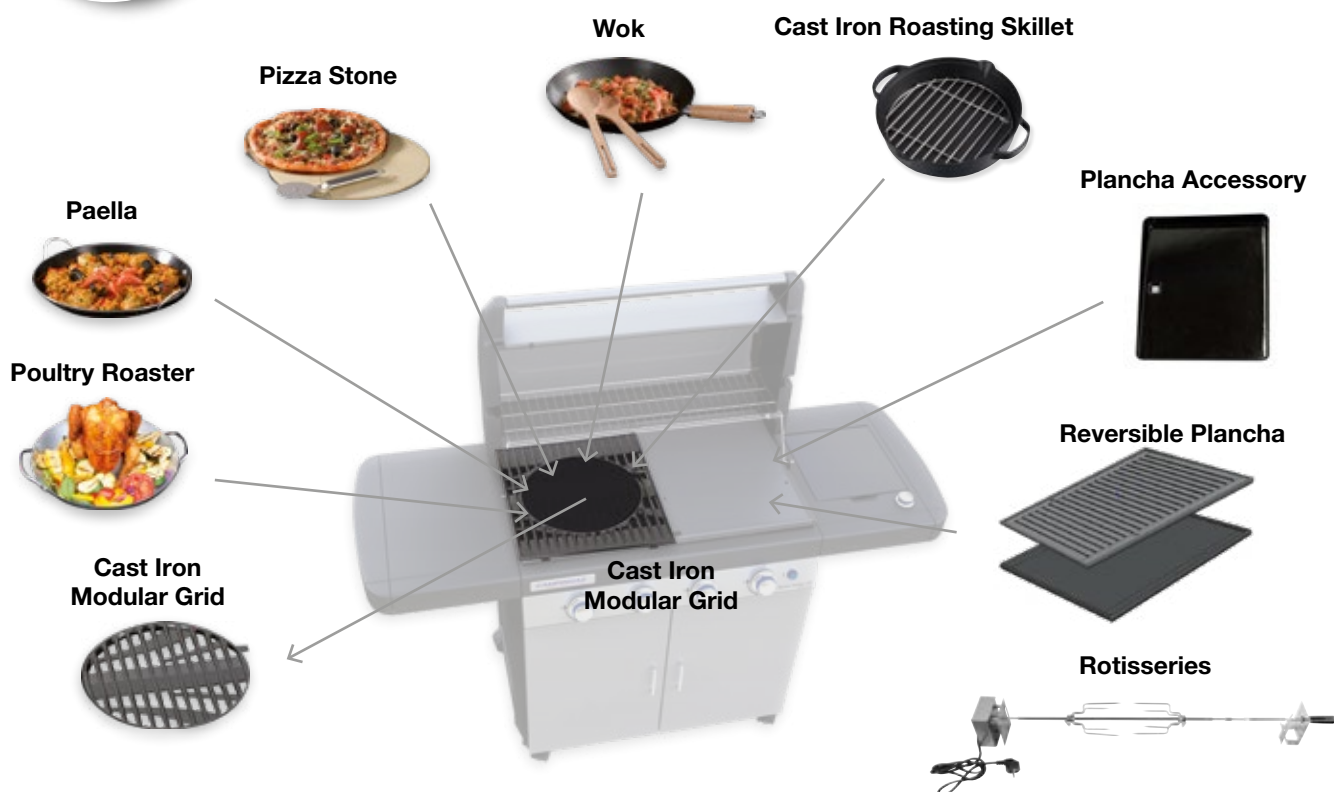

## Extend your kitchen outdoors with Campingaz® interchangeable cooking solutions!

Simply take out the inner ring of the cast iron modular, or remove / reverse the adjacent griddle and insert one of the various Campingaz® Culinary Modular Barbecue Accessories. (items sold separately)

The Campingaz® Culinary Modulares offer every option your gourmet barbecue heart desires.

**Cast Iron Culinary Modular Grid included on the following models: all Master Series BBQs, all Premium and Select models, all 3 and 4 Series LS Plus models**

**Cast Iron Culinary Modular Grid available as an upgrade and replacement for all 3 and 4 Series models and Master Series BBQs**



## STAINLESS STEEL TUBE BURNERS

---



**Powerful and durable stainless steel burners** for long lasting grilling dinners!

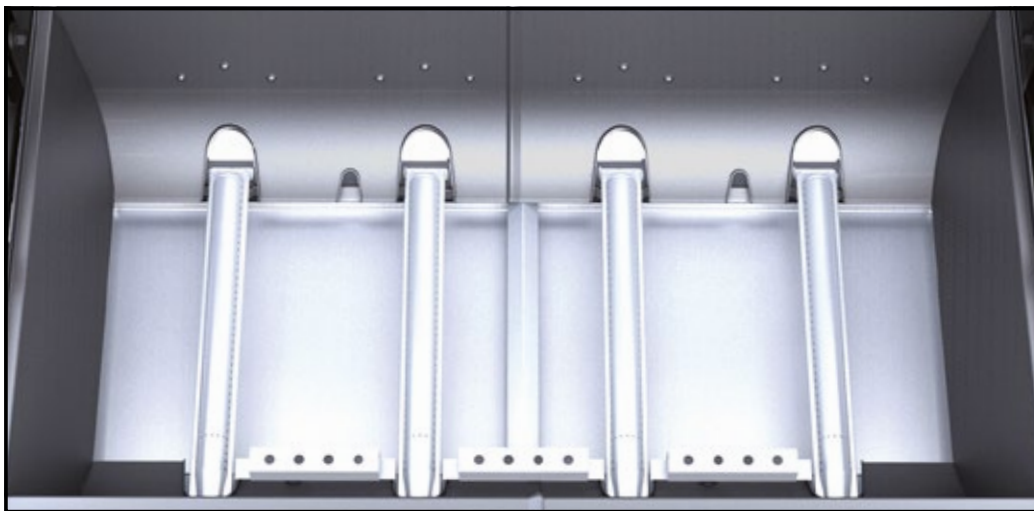

All Campingaz® 4/3/2 Series barbecues have a 3 year warranty on stainless steel tube burners

**Enjoy great cooking performance with this smart burner system designed to perfectly grill all types of foods.**

Specially designed burners create V-shaped flames that are directed towards the cooking grid and spread the heat evenly across the cooking surface.

The specifically designed burner protector, with protected ventilation slots, supports even heat distribution and prevents flare-ups.



# CLASSIC SERIES



	<b>4 Series Classic LS Plus Black</b>	<b>4 Series Classic LS Black</b>	<b>3 Series Classic LS Plus Black</b>	<b>3 Series Classic LS Black</b>
<b>Reference</b>	<b>2000031360</b>	<b>2000032724</b>	<b>2000031359</b>	<b>2000032694</b>
<b>EAN code</b>	3138522097769	3138522104351	3138522097752	3138522104245
<b>Cooking surface (cm<sup>2</sup>)</b>	3,500	3,500	2,800	2,800
<b>Cooking Dimensions (cm)</b>	78 x 45	78 x 45	61 x 46	61 x 46
<b>Burner</b>	Stainless Steel Tubes with 3 year warranty	Stainless Steel Tubes with 3 year warranty	Stainless Steel Tubes with 3 year warranty	Stainless Steel Tubes with 3 year warranty
<b>Number of burners</b>	4	4	3	3
<b>Power</b>	12.8 + 2.3 kW	12.8 + 2.3 kW	9.6 + 2.3 kW	9.6 + 2.3 kW
<b>Gas consumption</b>	931 + 167g/h	931 + 167g/h	698 + 167g/h	698 + 167g/h
<b>Campingaz InstaClean System</b>	Yes	Yes	Yes	Yes
<b>Cooking surface material</b>	Enamelled Cast Iron	Enamelled Stamped Steel	Enamelled Cast Iron	Enamelled Stamped Steel
<b>Cooking surface configuration</b>	Grid / Griddle	Grid / Griddle	Grid / Griddle	Grid / Griddle
<b>Ready for Culinary Modular Barbecue Accessories</b>	Yes	Optional	Yes	Optional
<b>Warming rack(s)</b>	75 x 17 cm	75 x 17 cm	60 x 17 cm	60 x 17 cm
<b>Rotisserie Option</b>	Yes	Yes	Yes	Yes
<b>Cooking height</b>	90.5 cm	90.5 cm	90.5 cm	90.5 cm
<b>Ignition</b>	Piezo	Piezo	Piezo	Piezo
<b>Thermometer</b>	Yes	Yes	Yes	Yes
<b>Side table(s)</b>	2	2	2	2
<b>Folding side table(s)</b>	1	1	1	1
<b>Side burner</b>	1	-	-	-
<b>Lid material</b>	Steel & aluminium die cast	Steel & aluminium die cast	Steel & aluminium die cast	Steel & aluminium die cast
<b>Trolley material</b>	Steel	Steel	Steel	Steel
<b>Trolley configuration</b>	2 doors, sides closed	2 doors, sides closed	2 doors, sides closed	2 doors, sides closed
<b>Wheels</b>	4 caster wheels	4 caster wheels	4 caster wheels	4 caster wheels
<b>Weight</b>	60 kg	57 kg	55.9 kg	50 kg
<b>Dimensions (L x W x H) in cm (open)</b>	160.5 x 65.5 x 147	160.5 x 65.5 x 147	144 x 65.5 x 147	144 x 65.5 x 147
<b>Dimensions (L x W x H) in cm (closed)</b>	137 x 60.5 x 116	137 x 60.5 x 116	120.5 x 60.5 x 116	120.5 x 60.5 x 116
<b>Qt. master carton (units)</b>	1	1	1	1
<b>Optional cover</b>	Classic XL (2000037297)	Classic XL (2000037297)	Classic L 2000037296	Classic L 2000037296





## 2 SERIES

Proving that good things come in small packages, the 2 Series Classic features a compact design with folding side tables for easy storage. Perfect for budget-conscious food lovers, the 2 Series Classic can be stored compactly until needed and is ideal for impromptu outdoor meals. Powerful stainless steel burners (EXS) offer effective and even heat and the family-sized enamelled cooking surface makes cooking for smaller groups effortless!







## 2 SERIES

### 2 Series Classic EXS Vario Black

3000006591



**Stainless steel burner** ensures durability for many seasons

**Integrated side burner** for preparing vegetables or sauces while grilling

**Utensil hooks** for hanging cooking accessories

**Convenient thermometer** enables heat monitoring and control

**Convenient piezo ignition** for matchless lighting

**Trolley doors** to conceal gas bottle during storage

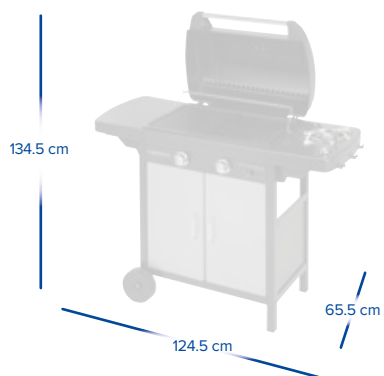



**Stainless Steel Burners**  
(included on EXS)



**Foldable Side Table(s)** for  
flexible storage



**Warming Rack**

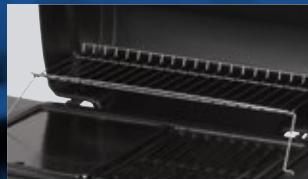

**2 Wheels for Mobility**





## 2 SERIES



	<b>2 Series Classic EXS Vario Black</b>	<b>2 Series Classic LX Plus Black</b>
Reference	<b>300006591</b>	<b>300006589</b>
EAN code	3138522120443	3138522120436
Cooking surface (cm <sup>2</sup> )	2,100	2,100
Cooking Dimensions (cm)	60 x 35	60 x 35
Burner	Stainless Steel	Aluminised Steel
Number of burners	2	2
Power	7.5 + 2.1 kW	7.5 kW
Gas consumption	546 + 153g/h	546g/h
Cooking surface material	Enamelled cast iron	Enamelled stamped steel
Cooking surface configuration	Grid /Griddle	Grid
Warming rack(s)	56 x 15 cm	56 x 15 cm
Cooking height	87 cm	87 cm
Ignition	Piezo	Piezo
Thermometer	Yes	Yes
Side table(s)	2	2
Folding side table(s)	1	2
Side burner	1	-
Lid material	Steel	Steel
Trolley material	Steel	Steel
Trolley configuration	2 doors, sides closed	2 doors, sides closed
Wheels	2	2
Weight	35 kg	28.4 kg
Dimensions (W x D x H) in cm (open)	124.5 x 65.5 x 134.5	124.5 x 65.5 x 134.5
Dimensions (W x D x H) in cm (closed)	106 x 51 x 109	87 x 51 x 109
Qt. master carton (units)	1	1
Optional cover	Premium M (2000037290) Classic M (2000037295)	Premium M (2000037290) Classic M (2000037295)

## SUGGESTED ACCESSORIES

---



**Premium Barbecue Cover M**  
2000037290  
See page 68



**Barbecue Cleaning Spray**  
205643  
See page 67



**3 in 1 Steel & Brass Bristled Brush**  
2000032608  
See page 62

## CAMPINGAZ® FEATURES\*

---



Stainless steel burners (included on EXS)



Integrated thermometer in lid improves heat monitoring



More cooking possibilities with a side burner that can be used with standard pots and pans.



Piezo ignition ensures convenient and matchless lighting



Side tables fold down for space saving storage



Number of people that can be comfortably served per grilling session

\*Depending on model



A background image showing a person in profile, holding a glass of wine, with a bottle of olive oil and a plate of food on a table in the foreground. The scene is set outdoors, with a large tree trunk visible in the background.

# XPERT

The Campingaz® Xpert range has been designed with a modern, fresh style, offering great value for money and is perfect for couples or smaller families. The Xpert barbecues are available in 2 different sizes, with a choice of a side burner for convenient preparation of side dishes or 2 foldable side tables for maximum space.

Each model of the Campingaz® Xpert range comes with a steel cooking lid and two burners, while reliable piezo ignition makes for a fuss-free start to your barbecue.







## XPERT

### Xpert 100L

3000004820



**Piezo ignition** ensures quick and convenient matchless ignition

**Foldable side tables** with utensil hooks for hanging cooking accessories

**Chromed wire grid** cooking surface

**Warming rack** for increased grilling versatility

**Two aluminised steel burners** for or perfectly even heat distribution

**Two big wheels** to ensure mobility also on uneven surfaces



## XPERT



### Xpert 100 L

Reference	<b>3000004820</b>
EAN code	3138522096267
Cooking surface (cm <sup>2</sup> )	1500
Cooking Dimensions (cm)	45 x 34 cm
Burner	Aluminised Steel
Number of burners	2
Power	7.1 kW
Gas consumption	515 g/h
Cooking surface material	Chromed Wire Grid
Cooking surface configuration	Grid
Cooking height	86cm
Ignition	Piezo
Thermometer	-
Side table(s)	2
Folding side table(s)	2
Side burner	-
Lid material	Painted Steel
Trolley material	Steel
Trolley configuration	100% Textile screen, side/back open
Wheels	2
Weight	15.4 kg
Dimensions (W x D x H) in cm (open)	98 x 50 x 124.5
Dimensions (W x D x H) in cm (closed)	66.5 x 50 x 99
Qt. master carton (units)	1
Optional cover	Classic S (2000037294)

## CAMPINGGAZ® FEATURES\*



Aluminised steel burners



Side tables fold down for space saving storage



Piezo ignition ensures convenient and matchless lighting



Number of people that can be served per grilling session

Double Burner



Foldable Side Table





The background image shows a woman with her hair in a bun, wearing a blue and white striped shirt, holding a plate of food. In the background, a blurred image of a Campingaz barbecue grill is visible, surrounded by greenery and purple flowers. The overall scene is set outdoors, likely at a campsite or a garden.

# ATTITUDE

The Campingaz® Attitude range of table top barbecues pairs sleek, urban styling with pioneering precision cooking, all within a compact, portable package. The Campingaz® Attitude 2go brings BBQ pleasures to all who want to stay flexible.

Intuitively designed for effortless barbecuing, you benefit from even heat distribution thanks to the Campingaz® Blue Flame burner system, a revolutionary digital temperature display for precise heat management and one-touch InstaStart™ ignition (on Attitude 2100 EX models).

The elegant lid of our Attitude 2100 models, opens to reveal a split cast iron grid and griddle, while the Culinary Modular Accessories allow you to unleash your cooking creativity with options from pizza to paella. When you're done, InstaClean™ ensures cleaning couldn't be easier - parts just pop in the dishwasher.







## **CAMPINGAZ® CULINARY MODULARS**



# **Campingaz® Culinary Modulares One System, Endless Possibilities!**



## **Redefine urban outdoor cooking with Campingaz® Culinary Modular accessories and the Campingaz® Attitude!**

Simply take out the inner ring of the cast iron modular and insert one of the various Campingaz® Culinary Modular Barbecue Accessories. (items sold separately - not compatible with Campingaz® Wok)

Cast Iron Culinary Modular Grid included on the Attitude 2100 LX and EX models.

## EVEN TEMP™ TECHNOLOGY

---

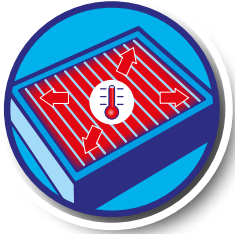

### Even Temp™ Technology Guarantees Even Heat Distribution



### Grill effectively and efficiently with our Even Temp™ Technology for perfectly even heat distribution

Campingaz® BBQs with Even Temp™ Technology cook your food evenly across the entire cooking surface of your barbecue.

Thanks to the patented Even Temp™ Technology, Campingaz® barbecues reach more than 250°C of the cooking surface.

This system is featured on all Master Series, 4 & 3 Series, Attitude Barbecues, and Master Plancha and Blue Flame Planchas





# ATTITUDE

## Attitude 2100 EX

2000035661



**Perfectly even heat distribution** enabled by durable Campinggaz® Blue Flame burner system



**Pre-assembled** table top grill – no screwdriver required!

**Blue Flame Burner design** ensures efficient and economic gas consumption

**Pioneering digital temperature display** measures the heat on the cooking surface for perfect and precise heat management

**Intuitive one touch InstaStart™** ignition with backlit safety controls that signify when the gas is on

**Split cast iron grid** and reversible griddle configuration offer all the right cooking surfaces to suit your BBQ favourites

**Front loading grease tray and InstaClean™** dishwasher safe parts ensure quick and simple cleaning

**Elegantly varnished black die cast aluminum lid** retains heat and ensures convection grilling

**Clever nickel chrome plated warming rack** enables versatile and indirect grilling

**10 year warranty** on the die cast aluminum lid and stainless steel burners

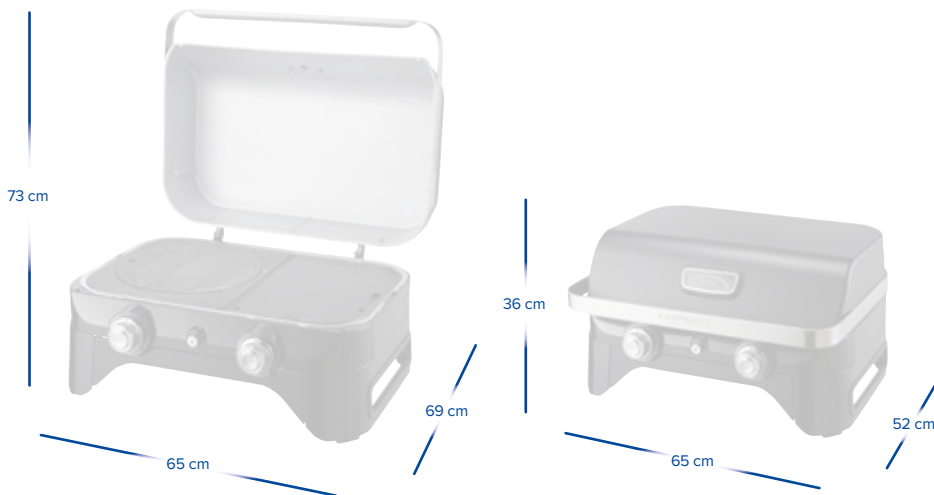

Patented Blue Flame Technology



Campinggaz InstaClean™ System



Campinggaz® Culinary Modular Barbecue Accessories



Even Temp™



Integrated Digital Thermometer Display



# ATTITUDE

## Attitude 2go CV

2000036952



**Pre-assembled** table top grill – no screwdriver required!

**Blue Flame Burner design** ensures efficient and economic gas consumption

**Front loading grease tray** dishwasher part which ensures quick and simple cleaning

**Elegantly matte black die cast aluminum lid** retains heat and ensures convection grilling

**10 year warranty** on the die cast aluminium lid and 5 year warranty on the enamelled cast iron cooking grids

**Hose and regulator with easy clic connection** comes included and attached. Attitude 2go CV runs on CV470 cartridges.

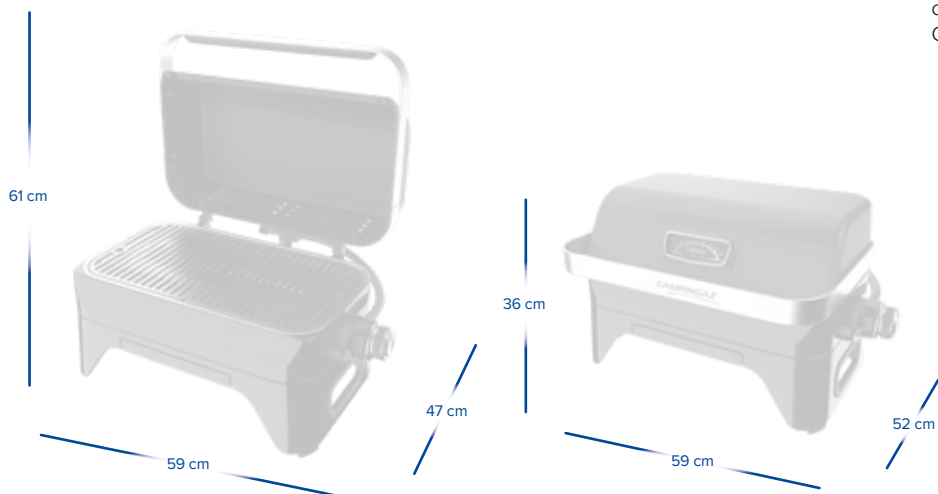



# ATTITUDE



	<b>Attitude 2100 EX</b>	<b>Attitude 2100 LX</b>	<b>Attitude 2go CV</b>	<b>Attitude 2go CV</b>	<b>Attitude 2go</b>
<b>Reference</b>	<b>2000035661</b>	<b>2000035660</b>	<b>2000036953</b>	<b>2000036952</b>	<b>2000036956</b>
<b>EAN code</b>	3138522114299	3138522114282	3138522117924	3138522117917	3138522117955
<b>Cooking surface (cm<sup>2</sup>)</b>	2,100 cm <sup>2</sup>	2,100 cm <sup>2</sup>	1,200 cm <sup>2</sup>	1,200 cm <sup>2</sup>	1,200 cm <sup>2</sup>
<b>Cooking Dimensions (cm)</b>	58 x 36	58 x 36	48 x 26 cm	48 x 26 cm	48 x 26 cm
<b>Burner</b>	Blue Flame Burner System (Stainless Steel)	Blue Flame Burner System (Aluminised Steel)	Blue Flame Burner System (Stainless steel)	Blue Flame Burner System (Stainless steel)	Blue Flame Burner System (Stainless steel)
<b>Number of burners</b>	2	2	1	1	1
<b>Power</b>	5 kW	5 kW	2.4 kW	2.4 kW	2.4 kW
<b>Cooking surface material</b>	Enamelled cast iron	Enamelled cast iron	Enamelled cast iron	Enamelled cast iron	Enamelled cast iron
<b>Cooking surface configuration</b>	Modular Grid / Griddle	Modular Grid / Griddle	Grid	Grid	Grid
<b>Warming Rack</b>	Included 56 x 13 cm	-	-	-	-
<b>Illuminated knobs</b>	Yes	-	-	-	-
<b>Ignition</b>	InstaStart™	Electronic ignition	Piezo	Piezo	Piezo
<b>Thermometer</b>	Digital	Yes	Yes	Yes	Yes
<b>Lid material</b>	Black varnished die cast aluminum	Matt black die cast aluminum	Grey matt die cast aluminium	Black matt die cast aluminium	Black matt die cast aluminium
<b>Weight</b>	24.5 kg	24.5 kg	13 kg	13 kg	13 kg
<b>Dimensions (W x D x H) in cm (open)</b>	65 x 69 x 73	65 x 69 x 73	59 x 47 x 61	59 x 47 x 61	59 x 46 x 61
<b>Dimensions (W x D x H) in cm (closed)</b>	65 x 52 x 36 cm	65 x 52 x 36 cm	59 x 52 x 36 cm	59 x 52 x 36 cm	59 x 39 x 36 cm
<b>Qt. master carton (units)</b>	1	1	1	1	1
<b>Optional cover</b>	Attitude 2100 Premium Cover (2000035417)	Attitude 2100 Premium Cover (2000035417)	-	-	-

## SUGGESTED ACCESSORIES



**Attitude 2100  
Premium Cover**  
2000035417  
*See page 68*



**CV470+ Multipack**  
300006258  
*See page 75*



**Deluxe Trolley**  
2000036959  
*See page 57*



**Culinary Modular Pizza  
Stone and Pizza Cutter**  
2000014582  
*See page 62*

## CAMPINGGAZ® FEATURES\*



Powerful patented Blue Flame burners for even heat distribution and great results with our Even Temp™ Technology



Intuitive one-touch InstaStart™ ignition



Campingaz InstaClean™ System ensures quick and effortless cleaning



Illuminated safety controls signify when the gas is on



Experience various cooking and grilling options with the Campingaz® Culinary Modularity. Only applicable on Attitude 2100 models



Number of people that can be comfortably served per grilling session



10 year warranty on the die cast aluminium lid and stainless steel burners (only on the Attitude 2100 EX)



No screwdriver required. All Attitude grills come completely pre-assembled.

\*Depending on model



The background of the entire page is a close-up photograph of food being cooked on a plancha. Several large, succulent shrimp are arranged in a row, their shells a vibrant orange-red color. Interspersed among the shrimp are slices of red onion, which appear to be cooking and softening. The plancha itself is a dark, flat surface, and the overall lighting is warm, highlighting the textures and colors of the ingredients.

## **PLANCHA COOKING**

Some of the healthiest and tastiest foods are styled after Mediterranean cuisine, a mix of southern European flavors from Greece, Spain, Italy, and France. Campingaz® planchas are designed in France and manufactured in Italy- two countries that understand that delicious food is also paired well with the enjoyment of cuisine.







## PLANCHA COOKING

With 300° to 350° Celsius, the Campingaz® plancha offers an optimum temperature range, especially for steaks, in which the hot plate caramelizes the sugars of the meat and ensures full-bodied roasted aromas. Excessive grease and liquids are transformed into pearls from intense heat and run off into a collecting container, and you'll find that the ingredients are actually roasted and not cooked. In addition to meat and fish, seafood or Julienne prepared vegetables and poultry are a characteristic example of the variety à la plancha is able to cook. The enamelled cast iron surface makes sauteing marinades or sauces effortless. Even alcohol, could be poured over to flambé, there are no limits here to à la plancha.



## Patented Blue Flame Burners Plancha Series



The patented Blue Flame Burners of the Campingaz® Planchas delivers exceptional even heat distribution. The

wide, blue flame burners sit right below the griddle to provide the right cooking temperature across the entire cooking surface. This ingenious Even Temp™ Technology provides the optimum surface temperature for perfect plancha cooking. The patented Blue Flame Burners on all Campingaz® Master Series Planchas are guaranteed for 10 years.



## Quick Cleaning in 4 Easy Steps

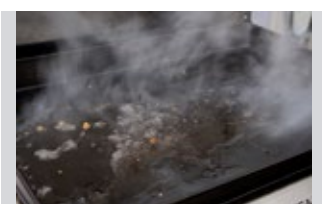

Pour water over the warm surface. Ice cubes not recommended



Scrap debris into drain hole



Remove contents from dishwasher-safe grease cup



Once the surface is slightly cool, wipe with damp cloth







## BLUE FLAME PLANCHA

Enjoy incredible cooking versatility with our sleek and stylish patented Blue Flame Plancha line from Campingaz®. Available in both stand alone and table top models, the Plancha Line features patented Blue Flame Burners to deliver exceptional even heat distribution with Even Temp™ Technology. Perfect for creating a wide range of different dishes, the Plancha range is perfect for families or groups who want to enjoy eating outdoors without compromising on variety.







CAMPINGGAZ



## BLUE FLAME PLANCHA

### Plancha BF LX

3000005414



**BLU** FLAME  
Performance & Efficiency

**Blue Flame Technology** for outstanding heat distribution

**Extra large cooking surface** with ample space for extensive Plancha grilling

**Protective lid** (only LX and EXL+) serves as windshield while cooking and protects the cooking surface during storage

**Easy to use grease** management system

**Electronic ignition** ensures quick and simple matchless ignition

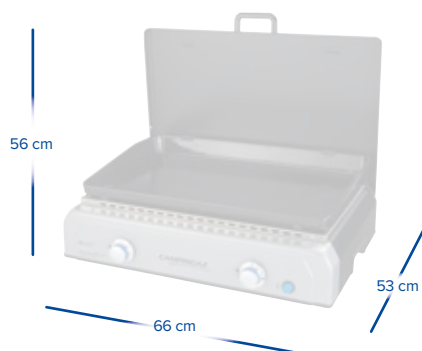

## BLUE FLAME PLANCHA

## CAMPINGAZ® FEATURES\*



**Plancha BF LX**

Reference	<b>3000005414</b>
EAN code	3138522103385
Cooking surface (cm <sup>2</sup> )	2,400
Cooking Dimensions (cm)	60 x 40 cm
Burner	Aluminised Steel
Burner Technology	Blue Flame Technology
Number of burners	2
Power	6 kW
Gas consumption	437 g/h
Cooking surface material	Enamelled Cast Iron
Cooking surface configuration	Plancha
Cooking height	-
Ignition	Electronic
Side table(s)	-
Folding side table(s)	-
Protective lid	Yes
Trolley material	-
Trolley configuration	-
Wheels	-
Weight	20.6 kg
Dimensions (W x D x H) in cm (open)	65.5 x 53 x 56
Dimensions (W x D x H) in cm (closed)	65.4 x 53 x 22
Qt. master carton (units)	1
Optional cover	Master Plancha Cover (2000030866)



The patented Blue Flame Burners of the Campingaz® Planchas delivers exceptional even heat distribution



Powerful Blue Flame burners for even heat distribution and great results with our Even Temp™ Technology



3 year warranty on stainless steel tube burners, providing strong performance and even heat



Piezo ignition ensures convenient and matchless lighting.



Number of people that can be served per grilling session

Patented Blue Flame Technology



Removable grease cup



Protective Lid (only LX and EX)



Integrated Handles (only LX and L)





# PLANCHAS

## Plancha L

3000005442



**Blue Flame Technology** for outstanding heat distribution

**Extra large cooking surface** with ample space for extensive Plancha grilling

**Integrated handles** for easy transportation

**Easy to use grease** management system

**Piezo ignition** ensures quick and simple matchless ignition

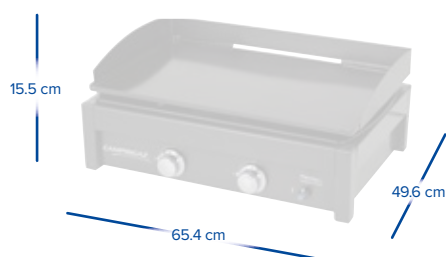

## SUGGESTED ACCESSORIES



	Plancha L	Deluxe Trolley
Reference	<b>3000005442</b>	<b>2000036959</b>
EAN code	3138522103668	3138522117986
Cooking surface (cm <sup>2</sup> )	2,400	-
Cooking Dimensions (cm)	66 x 42 cm	-
Burner	Aluminised Steel	-
Number of burners	Blue Flame Technology	-
Power	2	-
Gas consumption	6 kW	-
Cooking surface material	437 g/h	-
Cooking surface configuration	Enameled Stamped Steel	-
Ignition	Piezo	-
Protective lid	No	-
Trolley material	-	Steel
Wheels	-	2
Weight	16kg	22kg
Dimensions (L x W x H) in cm	65.4 x 49.6 x 15.5 cm	93 x 63 x 73 cm
Qt. master carton (units)	1	1
Optional cover	Classic Plancha (2000031422)	-

Patented Blue Flame Technology



Removable grease cup



Protective Lid (only LX and EX)



Integrated Handles



*\*Depending on model*



CAMPINGAZ®







# Barbecue Accessories

Improve your grilling experience from cooking to cleaning, with our recommended accessories.

Easily upgrade your barbecue with our Culinary Modulares and transform traditional grilling into a discovery of new flavors.



## OUR COOKING SURFACES

Campinggaz® cooking surfaces are engineered to provide you with all the tools needed for successfully cooking any recipe on our barbecues.

From grids to griddles that protect the grilled food from direct exposure to flames and even heat distribution. You'll find that cooking, grilling, or even baking are possible with Campinggaz's™ multiple cooking surfaces.



**Grid:** Steaks, sausages or larger pieces of meat should be grilled on a grid. Especially, if you want to achieve the characteristic BBQ grid pattern.



**Griddle:** The griddle is mainly used for delicate grill items, such as fish, vegetables, fruits or strips of meat. A griddle protects the grill items from direct exposure to flames and distributes heat more evenly. Most of our cast iron griddles are reversible and have a flat and ridged side for multiple cooking options.



**Warming Rack:** Different foods take different lengths of time to cook. A warming rack is a smaller second grill that's positioned above the main grill. The warming rack can keep food that has already been cooked hot without cooking it further allowing other slower-cooking food to catch up. It can also be used as an additional grilling surface when using the barbecue like an oven for dishes such as stuffed tomatoes or baked potatoes.



**Plancha:** Plancha-style embraces low-fat, high-heat cooking on a flat surface for delicious and easy-made dishes in a southern European flair. Grill a steak to perfection with an accompanied sautéed sauce. Or cook some Huevos Rotos con tortas at your next dinner party, followed by caramelized bananas. Cleaning is simple on our enamelled cast iron griddle.



**Twin Plancha:** For everyone who loves the flair of the southern kitchen, combined with the advantages of our griddle. This lifts your food above the grease that can drip down and flow into the grease evacuation channel. For our Planchas only.



## OUR COOKING MATERIALS

Campingaz® surface materials are engineered and tested to resist corrosion. In addition the materials used play a direct role in heat conduction and heat accumulation for even temperature distribution.

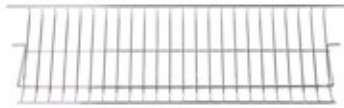

**Chromed Wire:** This material is often used for warming racks. The grids are very light but need special care as grill residues might burn into the material. Generally, chromed grids are dishwasher-safe, but we recommend a manual pre-cleaning with washing-up liquid and a sponge.



**Enamelled Wire:** Used on Xpert models and as warming rack in the Master Series. Compared to chromed wire grids, the Enamelled surface is easier to clean and protects the chrome. The grids are dishwasher-safe, but can also easily be cleaned with a sponge and detergent.



**Enamelled Stamped Steel Cooking Surfaces:** These cooking surfaces are lightweight, easy to handle and easy to clean. The enamelling prevents residue from burning into the material and sticking to the cooking surface. They are dishwasher-safe, but can also be easily cleaned with a sponge and detergent.



**Enamelled Cast Iron:** Enamelled cast iron grids and griddles conduct heat more intensively and sustainably than other materials. The pre-heating time of barbecues with cast iron cooking surfaces is slightly longer due to the thickness of the grids and griddles. The cast iron cooking surfaces are porcelain enamelled, protecting the cooking surface material from corrosion. They are produced in either a shiny/glossy look or in a textured, matte appearance. Grilled food doesn't stick as easily to the surface which aids cleaning and extends the lifetime of the cooking surface. We recommend to oil the cooking surface, regardless of the material, to avoid food from sticking to the surface.



**Stainless Steel:** A stainless steel plancha griddle sears meat perfectly and is a dependable and even cooking material that retains flavour. Durable stainless steel resists oxidation and rust. It's easy to clean without any residue breakdown over time. Simply pour some water on the warm surface and scrape food residue with a plancha spatula toward the residue hole, then wipe with a damp cloth.



All Campingaz® materials for cooking surfaces are certified to be used with food according to the EN 1935/2004. Additionally they have all passed a sensorial check to make sure that the material does not impact the taste of your recipe.



# CAMPINGAZ® CULINARY MODULAR BARBECUE ACCESSORIES

Along with the Culinary Modular Cast Iron Grid, you have the ability to use all Culinary Modular cooking inserts listed below. Simply remove the inner ring for use with the Pizza Stone, Wok, Poultry Roaster, Paella Pan. Please see page 62 for more information.



**Culinary Modular Pizza Stone and Pizza Cutter**

Ref: 2000014582 EAN: 3138522069711

**Compatible with Campingaz® Culinary Modular System.** Serve up a pizza at your next barbecue! Simply roll the pizza dough onto the stainless steel plate & transfer to the ceramic pizza stone insert over the grill. Grill with lid closed for a perfect result! Please see page 10 & 13 for more information.



**Culinary Modular Paella**

Ref: 2000015104 EAN: 3138522071301

**Compatible with Campingaz® Culinary Modular System.** The stainless steel, non-stick coated modular Paella pan fits directly into your cast-iron grid to ensure that heat is distributed evenly. Please see page 10 & 13 for more information.



**Culinary Modular Poultry Roaster**

Ref: 2000014576 EAN: 3138522069650

**Compatible with Campingaz® Culinary Modular System.** Simply fill the inner compartment with your favorite cooking liquid: beer, wine, broth, or any combination of oils and seasoning and place poultry directly on top of the cylinder. Please see page 10 & 13 for more information.



# Barbecues & Planchas



## Culinary Modular Cast Iron Wok

Ref: 2000036961

EAN: 3138522118013

**Compatible with Campingaz® Culinary Modular System.** Sturdy cast iron Wok, perfect for Asian dishes made directly on the grill.



## Culinary Modular Mandarin Wok

Ref: 2000038449

EAN: 3138522122720

**Compatible with Campingaz® Culinary Modular System.** Carbon steel wok with non-stick coating, perfect for Asian dishes made directly on the grill. Please see page 10 & 13 for more information.



All Campingaz® materials for cooking surfaces are certified to be used with food according to the EN 1935/2004. Additionally they have all passed a sensorial check to make sure that the material does not impact the taste of your recipe.



## Culinary Modular Cast Iron Roasting Skillet

Ref: 2000035416

EAN: 3138522113919

The cast iron skillet with integrated stainless steel rack offers an endless variety of uses. Roast larger pieces of meat or even an entire chicken, or remove the rack and make a casserole or crumble.

The skillet has deep walls to minimise cooking splashes and encloses juices for making sauces, while two spouts on the sides allow for drip-free pours. Large easy-grip handles, offer extra stability when lifting a full pan. Please see page 10 & 13 for more information.



## Culinary Modular Matt Grid

Ref: 2000031300

EAN: 3138522097561

**For use on Master Series and 3&4 Series Classic barbecues (except RBS™ models)**

Upgrade your barbecue with this Matt Culinary Modular Grid and Insert to grill either a pizza, a stir fry, or paella. Just remove the insert and cook with our Culinary Modulares. Made of cast-iron, it is an ideal cooking surface for multiple grilling styles.





# CAMPINGAZ® CULINARY MODULAR BARBECUE ACCESSORIES

Extend your kitchen outdoors with Campingaz® interchangeable cooking solutions!



**Premium Rotisserie Kit**

Ref: 2000036962 EAN: 3138522118020

**Compatible with all Campingaz® 3&4 burner barbecues (excl. Adelaide & 4 Series RBS)**

Kit composed of 1 electric motor, 1 spit, and two double forks. The heavy duty kit is dedicated to rotisserie cooking lovers. Its heavy duty spit and forks support a weight up to 3 kilograms!



**Plancha Accessory for Barbecue**

Ref: 2000031424 EAN: 3138522098292

**For use on Master Series and 3&4 Series Classic barbecues. Do not use in combination with a griddle surface. Not compatible with RBS™ barbecue**

Plancha or barbecue? Now you can have both! Designed by Campingaz® engineers, our plancha cooking surface is made of shiny cast iron and fits perfectly on our barbecues. The raised edges assist in easily turning your food, while experiencing "à la plancha" cooking style. For use on Master Series and 3&4 Series Classic barbecues. Should be placed on left side of barbecue. Do not use in combination with a griddle surface.



**Grid Lifter**

Ref: 2000037057 EAN: 3138522118259

A handy helper to lift your Campingaz® Culinary Modular grids.



## COOKING UTENSILS

Extend your kitchen outdoors with Campingaz® interchangeable cooking solutions!



**Premium Barbecue Stainless Steel Tongs**

Ref: 2000014567 EAN: 3138522069568

The long handles of the tongs ensure you won't get any nasty burns and the serrated ends ensure a good grip while you easily and effortlessly turn food.



**Genuine Lava Rocks**

Ref: 205637 EAN: 3138522056377

- Replacement pack
- Natural product with a porous surface
- Sufficient for a 1500cm<sup>2</sup> cooking surface

## BARBECUE GRIDS & BASKETS

Grilling multiple burgers, sausages or fish at the same time? Simplify rotating food and avoid singed arms with these handy grids and baskets.

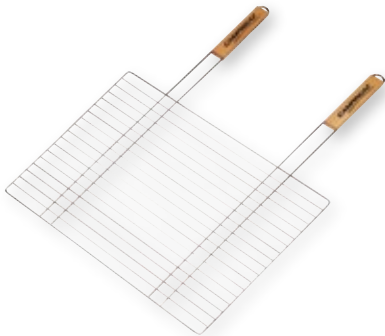

**Rectangular Single Grid Basket**

Ref: 205704 53x39cm EAN: 3138522057046  
Chrome plated double grid with wooden handles.



**Double Grid Basket**

Ref: 205689 35x25 cm EAN:3138522056896  
Ref: 205703 40x29cm EAN:3138522057039  
Ref: 205702 48x27.5cm EAN:3138522057022  
Chrome plated grid with wooden handle.



**Round Double Grid Basket**

Ref: 205817 Ø40cm EAN: 3138522058173  
Chrome plated double grid with wooden handle.



## UPGRADES AND REPLACEMENTS

Benefit from Campingaz<sup>®</sup>'s barbecue upgrades and replacement burner covers, grids, and InstaClean<sup>™</sup> kits to bring new life into your loved barbecue.



### Campingaz<sup>®</sup> Enamelled Protective Replacement Burner Covers - Set of 2

Ref: 2000033785

EAN: 3138522108885

Want to convert or simply replace your old burner protectors? Protect your burners with two burner covers made from enamelled steel when you replace your griddle with a Campingaz<sup>®</sup> Culinary Modular grid.

\*Grid sold separately





## CLEANING ACCESSORIES

The Campingaz® brand also offers a range of barbecue brushes as well as a cleaner spray to keep your barbecue as good as new.



**Barbecue Cleaning Spray**

**Ref: 205643**

EAN: 3138522056438

Get your barbecue clean and ready-to-use with the Campingaz® biodegradable spray. Spray the cooking surface, leave for approximately 5 minutes and rinse with clean water.



**3 in 1 Brush**

**Ref: 2000032608**

EAN: 3138522104078

One brush for three actions: scraping off grease with the metal scraper, rubbing away sticky food with the abrasive nylon pad and cleaning between the grill grates with the strong, brass bristled brush. Sold in 18 piece PDQ

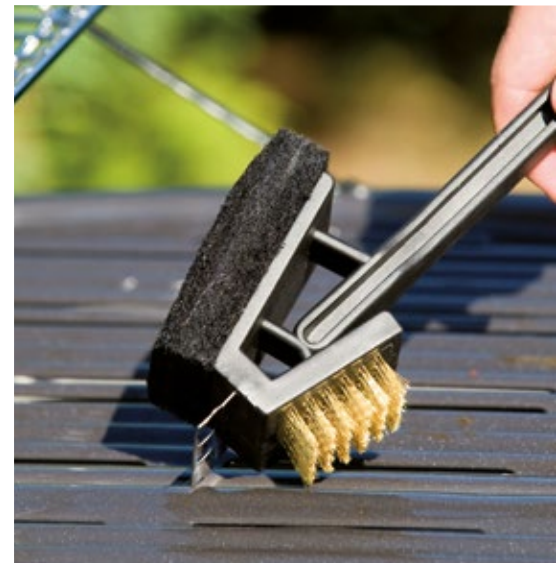

**Triangle Cleaning Brush**

**Ref: 2000032369**

EAN: 3138522103125

Stainless Steel brush with a plastic handle. Cover a larger surface of the grid compared to our classic brush. Total length: 32 cm





## MASTER COVERS

Protect your Master Series Planchas from the rain, wind and sun with the Master Plancha Cover. The treated waterproof cover will ensure your barbecue won't rust, fade or become damaged while not in use and can be secured with a tie for secure fitting.

### Master Plancha Cover

**Dimensions: 66 x 51 x 21 cm**

**Ref: 2000030866**

EAN: 3138522096663

Covers designed to fit the Campingaz<sup>®</sup> Master and Blue Flame Planchas. Perfect for protection against the sun, the rain and the cold. Designed to fit the Master Plancha L, LX and EX.

- Material: PU-coated polyester 300 x 300 D
- Ties and cord locks for secure fitting



### Master Cover

**Dimensions: 165/147 x 63 x 126 cm**

**Ref: 2000030864**

EAN: 3138522096649

Extendable cover designed to perfectly fit all Campingaz<sup>®</sup> Master Series barbecues, ensuring year-round weather-protection.

- Material: PU-coated polyester 300 x 300 D
- Strap system to secure the cover to the barbecue

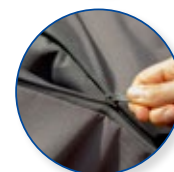

## PREMIUM BARBECUE COVERS

These covers don't just keep the rain out, they force condensation out too, using our water-resistant, breathable technology. Combine that with an included storage bag, and you've got a compact, unobtrusive and highly effective range of covers.

### XXL Cover

**Dimensions: 171 x 62 x 106 cm**

**Ref: 2000037293**

EAN: 3138522090012

### Attitude 2100 Premium Cover

**Dimensions: 66 x 51 x 35 cm**

**Ref: 2000035417**

EAN: 3138522113926



## CLASSIC BARBECUE AND PLANCHA COVERS

Covers to fit to wide range of Campingaz® barbecues, resistant to sun, rain and cold. Made of polyester, a robust, PVC-free high quality material providing your barbecue with great coverage.

### XL Cover

Dimensions: 159 x 65 x 118 cm

Ref: 2000037297 EAN: 3138522119386

### L Cover

Dimensions: 146 x 65 x 118 cm

Ref: 2000037296 EAN: 3138522119379

### M Cover

Dimensions: 136 x 62 x 102 cm

Ref: 2000037295 EAN: 3138522119362

### S Cover

Dimensions: 122 x 61 x 105 cm

Ref: 2000037294 EAN: 3138522119355

- Material: Black polyester 200 D
- Ties and cord locks for secure fitting



### COMPATIBILITY OF BARBECUE COVERS

		MASTER COVER	PREMIUM COVERS		CLASSIC BARBECUE COVERS			
		Master Plancha	XXL	Attitude 2100	S	M	L	XL
SKU		2000030866	2000037293	2000035417	2000037294	2000037295	2000037296	2000037297
Dimensions (LxWxH) in cm		66x51x21	171x62x106	66x51x21	122x61x105	136x62x102	146x65x118	159x65x118
Attitude	Attitude 2100 LX and EX			•				
2-Series	Classic L, LS, LX, EXS, EXS Vario					•		
3-Series	Woody or Classic L, LS, LS Plus, LX, Cast-Iron EXS Select, Select W, Select S, Premium, Premium W						•	
4-Series	Woody or Classic L, L Plus, LS, LS Plus, LX, LXS, Cast Iron EXS Select, Select S, Premium, Premium S, Onyx S						•	•
Master Series	Plancha Master L, LX, EX and Inox	•						
Xpert Series	Xpert 100 L, LW, L Rocky, LW Rocky, LS, LS Rocky				•			
	Xpert 200 L, LW, LS, LS Rocky				•			
Plancha Series	Plancha L	•						
	Plancha LX	•						
	Plancha EX, EXB	•						
	Plancha Blue Flame L and LX	•						



CAMPINGAZ®





# Cartridges & Cylinders

Energy for your outdoor-living! Powerful & convenient.

From lightweight stoves on backpacking adventures to powerful cookers at your favourite campsite; from gardening equipment to your hobby or DIY devices; our cartridges and cylinders are your source of energy. Easy to handle, safe and efficient!



## WHY YOU CAN RELY ON CAMPINGAZ®

---

Campingaz® is one of the European pioneers when it comes to portable energy solutions. Since 1949 Campingaz® branded products enable people to enjoy living and cooking outdoors.

### The Campingaz® R cylinders

- 100% Butane- consistently high quality
- Offered in 3 different sizes (0.4kg, 1.8kg, 2.75kg)
- Campingaz® cylinders are available and can be exchanged all over Europe and beyond
- Each cylinder is sophisticatedly maintained with each refill, with a primary concern for product safety
- 100% made and quality controlled in Europe

### The Campingaz® cartridges

- Available as Butane and Butane/Propane blend
- Available as a pierceable cartridge with innovative Gas Lock system (as of 2014)
- 100% quality controlled in Europe
- Available with the patented Easy Clic™ Plus valve system for utmost consumer comfort
- Dedicated cartridge solutions for distinct products like table top stoves and DIY tools
- Available all over Europe and beyond



**With Campingaz® you never run out of gas!**

## QUICK FACTS ABOUT THE DIFFERENT FORMS OF GAS...

---

The main difference between propane and butane is that propane is a three carbon alkane, consisting of three carbon atoms and eight hydrogen atoms, while butane is a four carbon alkane, with four carbon atoms and ten hydrogen atoms. Put simply, they stem from the same structures and differ only slightly.

Propane can be used and will perform at much lower temperatures than butane. It is a high pressure gas and therefore, has a higher performance than butane.

As butane pressure is lower in comparison to that of propane, the outer walls of butane cartridges need to be less robust than those of propane containers. Therefore, butane cartridges are lighter and can be stored more easily. Regulations on butane vs propane are also less restrictive and therefore it is an easier gas to transport.

All Campingaz® cartridges are either completely filled with butane, or some contain a butane and propane mix. The added 20% of propane to the 80% butane in the Campingaz® Valve Cartridges for instance, ensures a stronger performance as well as the possibility of ignition at lower temperatures whilst benefitting from the advantages of butane gas.



## CHOOSE THE RIGHT GAS...

---



### Refillable cylinders

Intended for regular use or for extended operating times. Available Europe-wide.



### Valve cartridges

Featuring a self-sealing valve, they can be disconnected and reconnected even when not empty!



### Pierceable cartridges

Economical single use cartridges that cannot be disconnected from a product until the cartridge is empty.

## 2 SECURE CONNECTION TYPES

---



### Easy Clic™ Plus, an even more convenient system made for valve cartridges – simply rotate 45° to get connected!

The Easy Clic™ Plus connection is the most simple and technically sophisticated connection which allows the fixing of a valve cartridge on a stove or on a lantern with a simple 45° rotation.



#### 1- Fix

Applying a small amount of pressure on the device with the cartridge is enough



#### 2- Turn

Apply a 45° left turn on the device and you're connected!



### Screw in system for the cylinder connection



1- **Insert** the device in the valve head of the cylinder



2- **Turn** right to screw it in and connect, turn left to unscrew



## REFILLABLE CYLINDERS

These bigger, heavier cylinders are designed for more prolonged, intensive or regular use. They are fitted with a safety valve and are available Europe-wide.



### Exchange your cylinder

With the Campingaz® cylinder exchange system, you can bring your empty cylinder to a Campingaz® product retailer in France, UK, Germany, Italy, Spain, Benelux (and dozens of other countries), and get a full cylinder for the price of just the refill. It's as simple as that.



#### R901

- Contains 0.4kg Butane
- Size (without cap) ø 11 x 15 cm
- Weight: 1.40kg

Ref: 30408\*  
EAN: 3138520061694



#### R904

- Contains 1.8kg Butane
- Size (without cap) ø 20 x 14.5 cm
- Weight: 4.81kg

Ref: 30409\*  
EAN: 3138520061700



#### R907

- Contains 2.75 kg Butane
- Size (without cap) ø 20.3 x 23.5 cm
- Weight: 6.46kg

Ref: 30410\*  
EAN: 3138520061717

\* References for empty cylinder. Please contact local distributor for further information on gas cylinders.

## VALVE CARTRIDGES

Our range of valve cartridges have a high security self-sealing valve giving them all the advantages of being resealable – so they can be disconnected and reconnected even when they're not empty. Ideal for periodic, moderate use.

### Butane/Propane mix

Recommended for better performance at low temperatures.



#### CV300 Plus

- Contains 240g Butane/Propane mix (80/20)
- Size (without cap) ø 9 x 10.5 cm
- Weight: 410 g

Ref: 300005758  
EAN: 3138522109301



#### CV470 Plus

- Contains 450g Butane/Propane mix (80/20)
- Size (without cap) ø 11 x 14 cm
- Weight: 710 g

Ref: 300005761  
EAN: 3138522109332



#### CP250

For Bistro™ type stoves.

- contains 220g of Butane/Isobutane mix
- Size (without cap) ø 6.9 x 18 cm
- Weight: 315 g

Ref: 2000033971  
EAN: 3138522109271



#### CV360

Compact cartridge used for DIY purposes

- Contains 52g Butane
- Size (without cap) ø 3.8 x 14.1 cm
- Weight: 110 g

Ref: 39350  
EAN: 3138520193128



#### CG3500 GA

Garden gas for garden torches

- Contains 350g Butane/Propane mix (70/30)
- Size (without cap) ø 6.8 x 25.7 cm
- Weight: 520 g

Ref: 300005833  
EAN: 3138522088781

## PIERCEABLE CARTRIDGES

Pierceable cartridges can't be disconnected once they've been plugged into an appliance, so they're suitable for more intensive or longer use – they're also our most economical and widely available cartridges.

### C206 GLS

The cartridge has an integrated leakage limiter, the Gas Lock System, which is compliant to the European standard EN 417:2012 legislation. The system prevents the majority of residual gas from escaping the cartridge when accidentally disconnecting it from the appliance, thereby also preventing flare-ups.



### C206 GLS

- Contains 190g Butane or Butane/Propane mix (80/20)
- Size (without cap) ø 9 x 9.5 cm
- Weight: 280 g

**Ref: 3000005772 - Butane/Propane mix**  
EAN: 3138522109448



### Cartridges CV470+ 4pack Duolabel

- Contains 4x CV470
  - Size: 22.8 x 22.4 x 14.5 cm
  - Weight: 2.68kg
- Include packaging picture

**Ref: 3000006258**  
EAN: 3138522117115



## EXCHANGE YOUR CYLINDER

### What to do with a refillable cylinder when it is empty?

#### The 3 different gas cylinder recycling models:

##### 1/ The common model

A deposit is left when you purchase your first cylinder of gas. Part of this deposit is received back when you return it to a retailer of gas. This model is usually limited to the national territory. For example, generally a French returnable cylinder cannot be exchanged in another country.



##### 2/ The Campingaz® model

The Campingaz® refillable cylinder model that has been used for more than 60 years is different; when you purchase a gas cylinder you become the owner of this cylinder. You can exchange your empty cylinder for a full cylinder whenever you want and wherever you go, even abroad. This exchange model for empty cylinder, with which you only purchase the actual bottle once, gives you more flexibility. All information about this system is printed on the top of each cylinder.

##### 3/ Recycling returnable cylinders

If you don't need to use your cylinder anymore, you can return it to a retailer or a recycling centre. They will be accepted free of charge.

All returned cylinders are brought back to the factory where they were initially filled, where they are repaired and given a second life if their condition allows it. If it is not the case, they will be recycled.

This initiative is aligned with the Campingaz® value for environmental and sustainable development.



# Cartridges & Cylinders



Scan the QR code or go to the website below for a full list of stores that carry Campingaz® cartridges and/or offer Campingaz® refillable cylinders across EMEA.

[www.campingaz.com/gasfinder/](http://www.campingaz.com/gasfinder/)







**camping gaz international**

4.000 litres maximum  
à 170.000  
pour le chauffage  
à 100.000 pour le chauffage  
à 100.000 pour le chauffage

avec  
système  
Camping  
System

REG. ENTREP. 174, 180, 181, 182, 183, 184, 185, 186, 187, 188, 189, 190, 191, 192, 193, 194, 195, 196, 197, 198, 199, 200, 201, 202, 203, 204, 205, 206, 207, 208, 209, 210, 211, 212, 213, 214, 215, 216, 217, 218, 219, 220, 221, 222, 223, 224, 225, 226, 227, 228, 229, 230, 231, 232, 233, 234, 235, 236, 237, 238, 239, 240, 241, 242, 243, 244, 245, 246, 247, 248, 249, 250, 251, 252, 253, 254, 255, 256, 257, 258, 259, 260, 261, 262, 263, 264, 265, 266, 267, 268, 269, 270, 271, 272, 273, 274, 275, 276, 277, 278, 279, 280, 281, 282, 283, 284, 285, 286, 287, 288, 289, 290, 291, 292, 293, 294, 295, 296, 297, 298, 299, 300, 301, 302, 303, 304, 305, 306, 307, 308, 309, 310, 311, 312, 313, 314, 315, 316, 317, 318, 319, 320, 321, 322, 323, 324, 325, 326, 327, 328, 329, 330, 331, 332, 333, 334, 335, 336, 337, 338, 339, 340, 341, 342, 343, 344, 345, 346, 347, 348, 349, 350, 351, 352, 353, 354, 355, 356, 357, 358, 359, 360, 361, 362, 363, 364, 365, 366, 367, 368, 369, 370, 371, 372, 373, 374, 375, 376, 377, 378, 379, 380, 381, 382, 383, 384, 385, 386, 387, 388, 389, 390, 391, 392, 393, 394, 395, 396, 397, 398, 399, 400, 401, 402, 403, 404, 405, 406, 407, 408, 409, 410, 411, 412, 413, 414, 415, 416, 417, 418, 419, 420, 421, 422, 423, 424, 425, 426, 427, 428, 429, 430, 431, 432, 433, 434, 435, 436, 437, 438, 439, 440, 441, 442, 443, 444, 445, 446, 447, 448, 449, 450, 451, 452, 453, 454, 455, 456, 457, 458, 459, 460, 461, 462, 463, 464, 465, 466, 467, 468, 469, 470, 471, 472, 473, 474, 475, 476, 477, 478, 479, 480, 481, 482, 483, 484, 485, 486, 487, 488, 489, 490, 491, 492, 493, 494, 495, 496, 497, 498, 499, 500, 501, 502, 503, 504, 505, 506, 507, 508, 509, 510, 511, 512, 513, 514, 515, 516, 517, 518, 519, 520, 521, 522, 523, 524, 525, 526, 527, 528, 529, 530, 531, 532, 533, 534, 535, 536, 537, 538, 539, 540, 541, 542, 543, 544, 545, 546, 547, 548, 549, 550, 551, 552, 553, 554, 555, 556, 557, 558, 559, 560, 561, 562, 563, 564, 565, 566, 567, 568, 569, 570, 571, 572, 573, 574, 575, 576, 577, 578, 579, 580, 581, 582, 583, 584, 585, 586, 587, 588, 589, 590, 591, 592, 593, 594, 595, 596, 597, 598, 599, 600, 601, 602, 603, 604, 605, 606, 607, 608, 609, 610, 611, 612, 613, 614, 615, 616, 617, 618, 619, 620, 621, 622, 623, 624, 625, 626, 627, 628, 629, 630, 631, 632, 633, 634, 635, 636, 637, 638, 639, 640, 641, 642, 643, 644, 645, 646, 647, 648, 649, 650, 651, 652, 653, 654, 655, 656, 657, 658, 659, 660, 661, 662, 663, 664, 665, 666, 667, 668, 669, 670, 671, 672, 673, 674, 675, 676, 677, 678, 679, 680, 681, 682, 683, 684, 685, 686, 687, 688, 689, 690, 691, 692, 693, 694, 695, 696, 697, 698, 699, 700, 701, 702, 703, 704, 705, 706, 707, 708, 709, 710, 711, 712, 713, 714, 715, 716, 717, 718, 719, 720, 721, 722, 723, 724, 725, 726, 727, 728, 729, 730, 731, 732, 733, 734, 735, 736, 737, 738, 739, 740, 741, 742, 743, 744, 745, 746, 747, 748, 749, 750, 751, 752, 753, 754, 755, 756, 757, 758, 759, 760, 761, 762, 763, 764, 765, 766, 767, 768, 769, 770, 771, 772, 773, 774, 775, 776, 777, 778, 779, 780, 781, 782, 783, 784, 785, 786, 787, 788, 789, 790, 791, 792, 793, 794, 795, 796, 797, 798, 799, 800, 801, 802, 803, 804, 805, 806, 807, 808, 809, 810, 811, 812, 813, 814, 815, 816, 817, 818, 819, 820, 821, 822, 823, 824, 825, 826, 827, 828, 829, 830, 831, 832, 833, 834, 835, 836, 837, 838, 839, 840, 841, 842, 843, 844, 845, 846, 847, 848, 849, 850, 851, 852, 853, 854, 855, 856, 857, 858, 859, 860, 861, 862, 863, 864, 865, 866, 867, 868, 869, 870, 871, 872, 873, 874, 875, 876, 877, 878, 879, 880, 881, 882, 883, 884, 885, 886, 887, 888, 889, 890, 891, 892, 893, 894, 895, 896, 897, 898, 899, 900, 901, 902, 903, 904, 905, 906, 907, 908, 909, 910, 911, 912, 913, 914, 915, 916, 917, 918, 919, 920, 921, 922, 923, 924, 925, 926, 927, 928, 929, 930, 931, 932, 933, 934, 935, 936, 937, 938, 939, 940, 941, 942, 943, 944, 945, 946, 947, 948, 949, 950, 951, 952, 953, 954, 955, 956, 957, 958, 959, 960, 961, 962, 963, 964, 965, 966, 967, 968, 969, 970, 971, 972, 973, 974, 975, 976, 977, 978, 979, 980, 981, 982, 983, 984, 985, 986, 987, 988, 989, 990, 991, 992, 993, 994, 995, 996, 997, 998, 999, 1000

**LES NOUVEAUX BARBECUES A GAZ ET PIERRES DE LAVE**

**camping gaz**

**3 types de réservoirs à gaz butane**

Must use with positive pressure system or 2-stage, depending on the gas appliance to be used.

**Echange standard des réservoirs partout en Europe**

**901**

TARA K 0,740  
LIQUIGAS K 0,500  
TOTALE K 1,240

**904**

TARA K 2,800  
LIQUIGAS K 2,000  
TOTALE K 4,800

**907**

TARA K 3,500  
LIQUIGAS K 3,000  
TOTALE K 6,500

**CUCINA SPORT**

**YOU'RE ANYWHERE, WE'RE EVERYWHERE**

**CAMPINGGAZ**



**CAMPING-GAZ**



**Cartouche grandeur nature.**

**il a suffi d'une cartouche**

**pour vous rendre la vie plus agréable et plus facile en plein air... et chez vous!**

Cette cartouche de butane interbénéficiante... c'est la grande nouveauté.

**BIDON BLEU - CAMPING GAZ**

Elle s'adapte aux appareils d'utilisation aussi facilement qu'une cartouche de biogaz ou une recharge de gaz.

**\* vous trouverez cette cartouche partout en Europe**

## Choose the European Leader in Gas Distribution!

- Campinggaz® energy solutions are available throughout Europe and beyond.
- No need to switch your gas source during vacation! You'll save money by not needing to purchase hoses, regulators, or new appliances to comply with the local standard.
- Our refillable cylinders can be exchanged at any Campinggaz® retailer throughout Europe, without needing to buy a new one.
- To find up-to-date store locations and availability please visit our gas finder at [Campinggaz.com/gasfinder](https://Campinggaz.com/gasfinder)

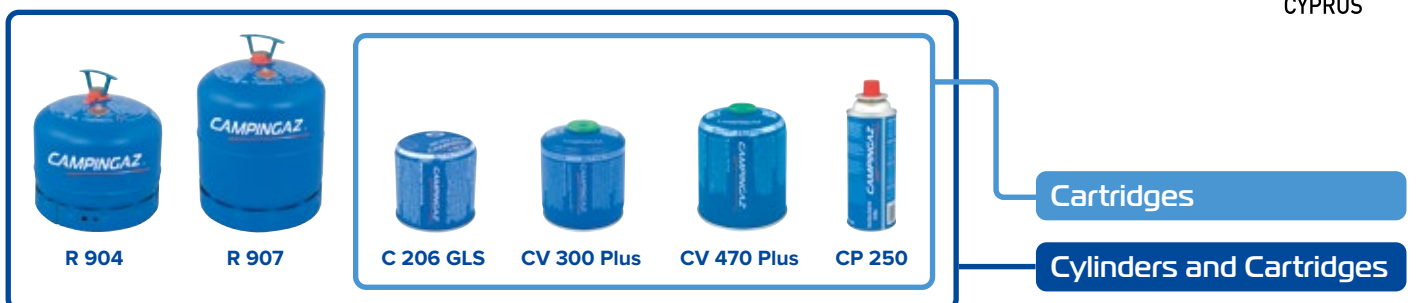
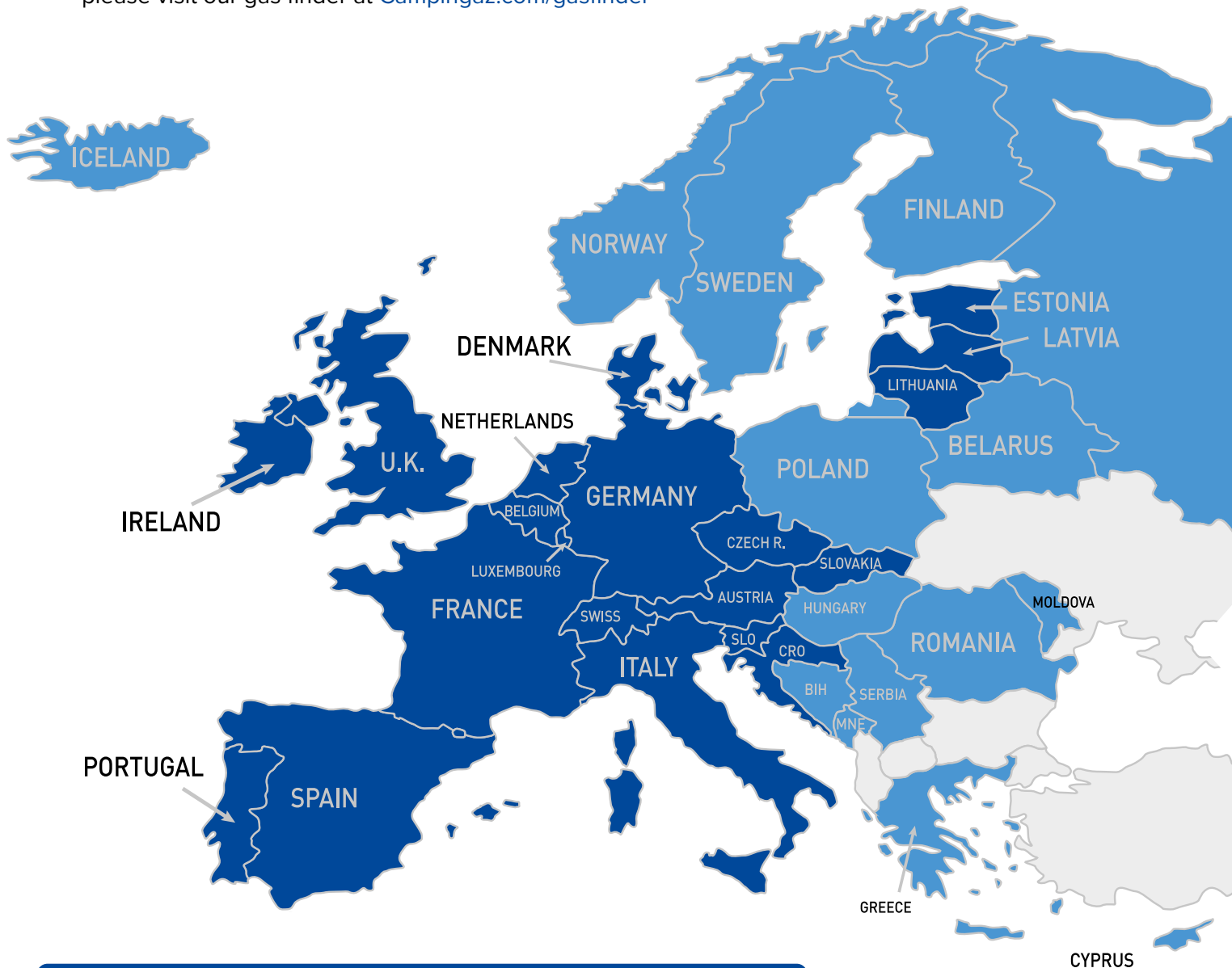

Cartridge and Cylinder Assortment may vary



CAMPINGAZ®







# Food Preparation

Whether you're on the side of a mountain or out on a family trip, we've got everything you need for a meal on the go.

Make more out of a meal with our wide range of innovative stoves. All grills and stoves are supported by our globally available range of gas cartridges and cylinders. Whichever you choose, you can be sure that they're reliable, safe and practical.



## MULTI-COOKING OPTIONS

### The Campingaz® cooking world – a world of multi-cooking options!

Whether camping with family and friends, for long or short periods, for a day on the beach or a simple picnic in a park, Campingaz® offers a wide range of portable stoves that enable all cooking possibilities. There is no need to compromise, even when outdoors, you have all the options to prepare your favourite meals, like at home.

Why not prepare an English breakfast with beans, sausages and toast? Or perhaps grill some fresh fish whilst cooking some pasta? Alternatively, you may prefer to bake a pizza? All these tasty dishes are possible with the Campingaz® gas stove range.

#### Cooking



#### Grilling



#### Toasting

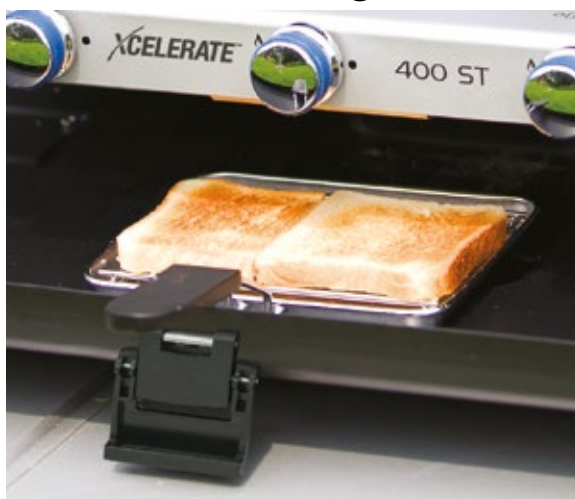

#### Spit style roasting



## CHOOSE THE RIGHT STOVE...

---

**Make sure you choose the right stove for your needs.**

### 1. Cartridge or cylinder?

Cylinder stoves are designed to run for much longer and produce more power for intensive use. Refillable cylinders are heavy and not very practical if you're going hiking. For portability, a cartridge stove is the way to go! Each of our two burner cylinder stoves can run off either Campingaz® R904/907 gas cylinders or any standard butane or propane 6kg gas cylinder.

### 2. Single or multi-burner?

A single-burner stove is lighter and more compact but only allows you to cook one thing at a time. Two burner stoves give you more options for your cooking and often come with a stand but can be a little less handy and more heavy than a single-burner stove.

### 3. Burner and grill?

Ask yourself what kind of cooking you would like to do. If you intend on mainly making a cup of tea or heating baked beans, one burner may be enough. If you want to cook a full breakfast, consider a burner and grill combination.

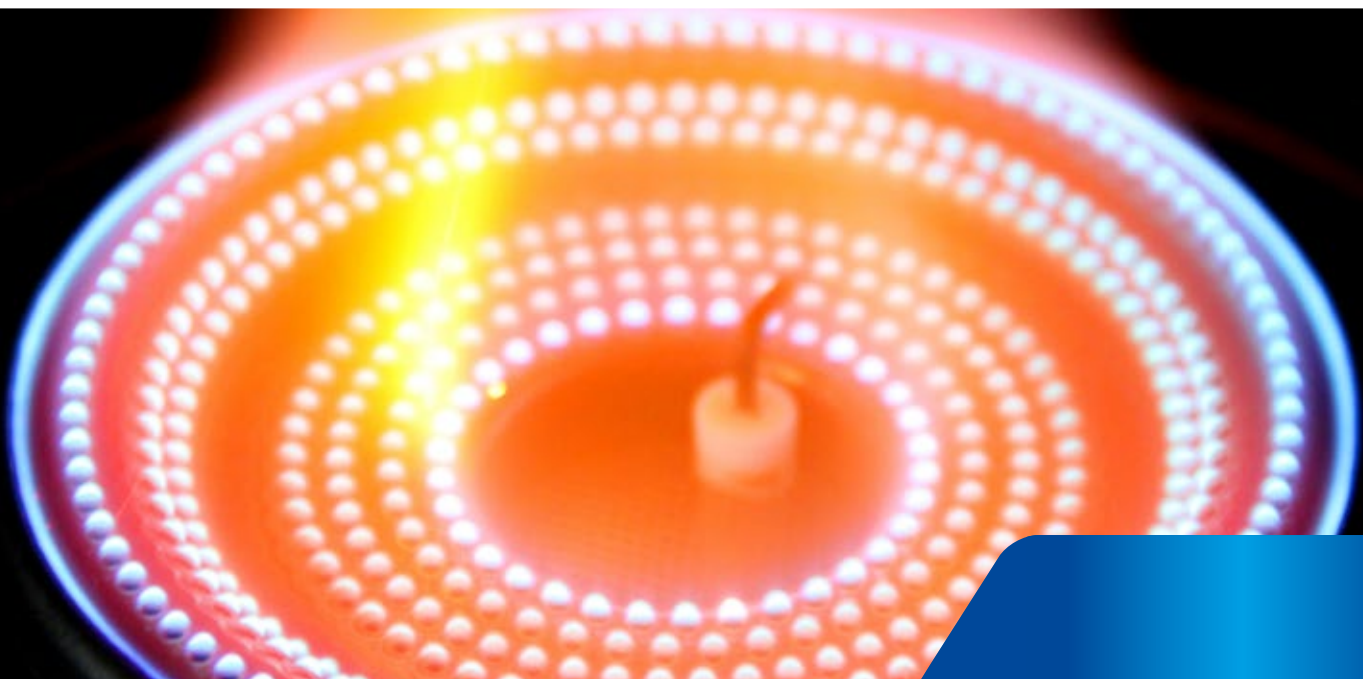



## XCELERATE™ TECHNOLOGY

Campingaz<sup>®</sup> presents another innovation in camping stove technology .

**Cut your boil time in half** with **Xcelerate™ Technology**. The combination of the Xcelerate™ burner and wind blocking pan supports provides the ultimate wind resistance for your gas stove flame, reducing gas consumption and the time you spend cooking, giving you more time for recreation in the outdoors.

### Xcelerate™ Burner

The patented burner technology features a lower, more wind resistant, higher performance flame that produces results unmatched by regular burners.

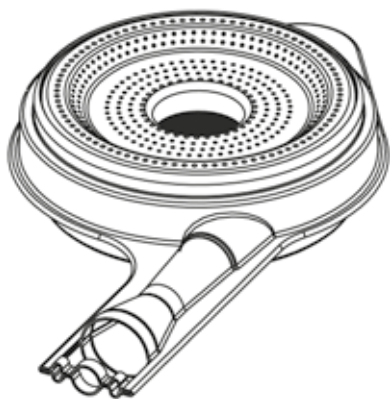

Downward “stepped” design and increased heating surface area.

### WindBlock™ Pan Support

The patented pan support technology creates a barrier around the burner that provides superior wind deflection.

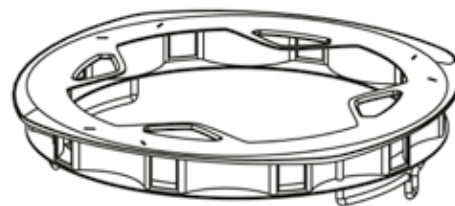

Wind is redirected and cannot enter the cooking area.

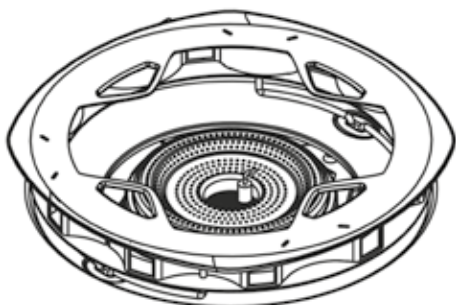

**XCELERATE**<sup>®</sup>  
Technology



## CUT YOUR BOIL TIME IN HALF!

**XCELERATE**<sup>®</sup>  
Technology

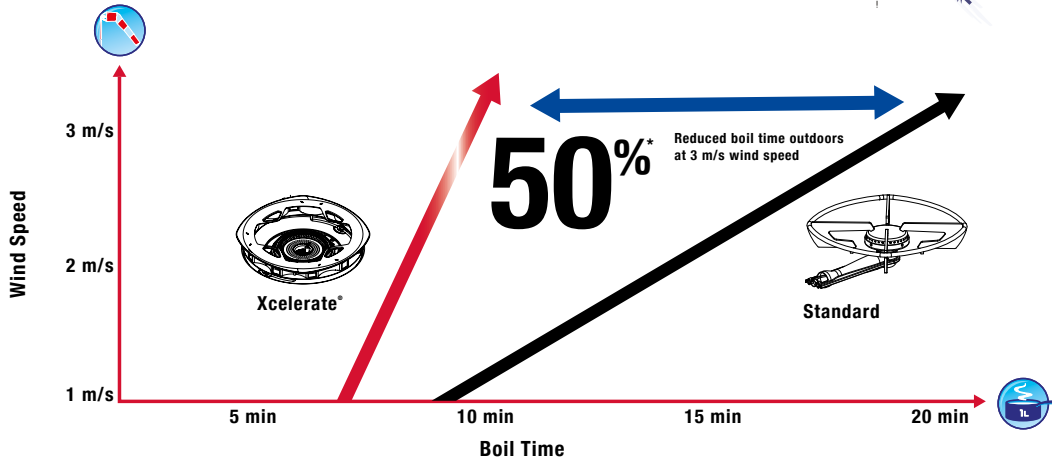
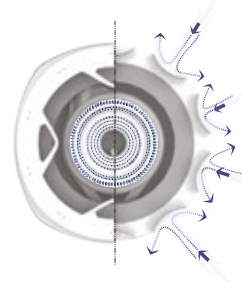

Wind speed	Boil time using 200mm pot	Gas consumption in g per hour
3 m/s	10 mins	200 mm 26 g
	20 mins	57 g
1 m/s	7 mins	200 mm 18 g
	8 mins	23 g



*Tested in a laboratory according to internal standards.*



## XCELERATE™ SERIES

The portable 2-burner stove line from Campingaz® combines a sleek design and innovative technology for a drastically improved cooking performance. Enjoy a large range of outdoor cooking options: cook, grill and toast with fast and safe devices. Easy to start with a piezo ignition. Next to our table-top solutions, the 600-SG has telescopic legs that increase comfort when cooking. When dismantled it can be easily stored away underneath the stove, so that this stove can be effortlessly carried everywhere.

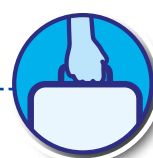

Sturdy painted steel lid with chromed handle

Powerful burners at 4400W with Xcelerate™ technology, ensure that outdoor boiling times are twice as fast as other stoves

Strong side tables to increase cooking convenience

Resilient and easy to store textile tray, ideal for storing light accessories and utensils

Telescopic legs, easy to assemble/disassemble and easy to store

**600 SG**  
2000015086

## MAIN FEATURES

2 Xcelerate™ burners



Double option of grilling and cooking on the 600 SG



Completely foldable for easy transportation



Piezo ignition



Convenient carry handle



## 600 SERIES STOVES SG

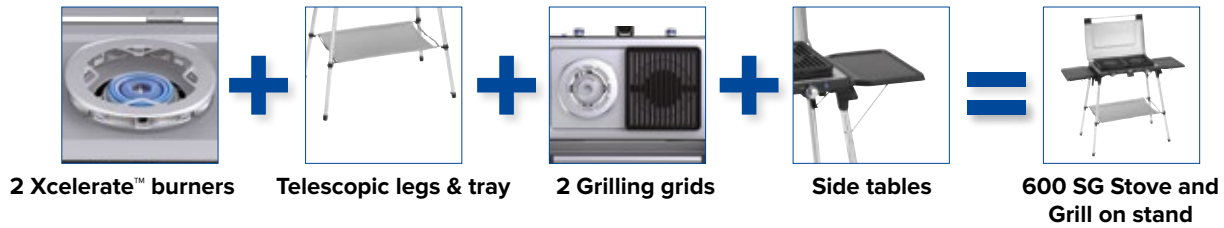

## 400 SERIES STOVES SG, ST AND S

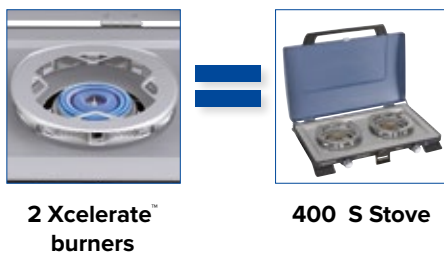
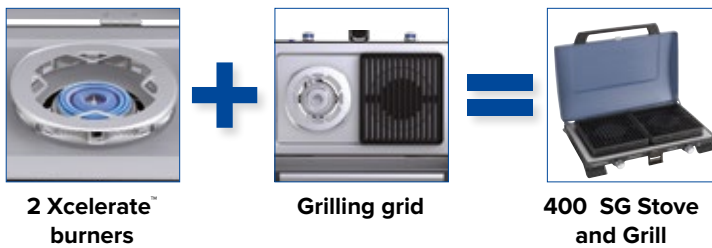

	600 SG	400 SG	400 S
Reference	2000015086	2000032230	2000032226
EAN code	3138522071271	3138522101664	3138522101626
Power	Xcelerate™ burner 2x2,200W	Xcelerate™ burner 2x2,200W	Xcelerate™ burner 2x2,200W
Gas consumption	2x165 g/h	2x165 g/h	2x165 g/h
Outdoor boil time (at 3 m/s wind speed)	1L in 10min	1L in 10min.	1L in 10min.
Ignition	Piezo	Piezo	Piezo
Runtime	5:30h (R904) 9:30h (R907) 16h (5kg cylinder)	5:30h (R904) 8:30h (R907) 16h (5kg cylinder)	5:30h (R904) 8:30h (R907) 16h (5kg cylinder)
Lid material	Painted Steel	Painted Steel	Painted Steel
Fuel source	R904, R907, butane or propane cylinder	R904, R907, butane or propane cylinder	R904, R907, butane or propane cylinder
Weight	10.7kg	7.8kg	6kg
Dimensions open (LxWxH)	107.5 x 57.5 x 112.5 cm	55.5 x 44.5 x 46 cm	55.5 x 44.5 x 46 cm
Dimensions closed (LxWxH)	63 x 42 x 18.5 cm	55.5 x 42.5 x 13.5 cm	55.5 x 42.5 x 13.5 cm
Qt. Master carton (units)	2	2	2



# CAMPING KITCHEN™ 2 CV

The Camping Kitchen™ 2 is the perfect companion stove for any family trip, either for a quick weekend away or for a longer stay. Campinggaz Camping Kitchen™ 2 is a light and easily portable, two burner stove that is available both in a cartridge and cylinder version depending on the length of your vacation. It also features heat resistant side panels with enameled steel pan supports that doubles as wind protection.



### Regulator and Hose Included

Side panels come with built-in carry grips and the lid has a secure, steel lock

Removable dishwasher-safe pan supports hold two pans up to 24cm in diameter

Sturdy steel lid

Push and turn knobs for full flame control

### ALSO AVAILABLE



**Camping Kitchen™ 2**  
2000035521



**Camping Kitchen™ 2 CV PZ**  
2000035941

Available with piezo ignition

**Camping Kitchen™ 2 CV**  
2000035522

	Camping Kitchen™ 2	Camping Kitchen™ 2 CV	Camping Kitchen™ 2 CV
Reference	2000035521	2000035522	2000035522
EAN code	3138522114015	3138522114022	3138522114022
Power	2 x 2000W	2 x 2000W	2 x 2000W
Gas consumption	291g/h	291g/h	291g/h
Boil time	5 min 45 sec	6 min 30 sec	6 min 30 sec
Ignition	Manual	Manual	Piezo
Runtime	R907(9h30m) R904(6h10m)	CV470(1h30m)	CV470(1h30m)
Lid material	Painted Steel	Painted Steel	Painted Steel
Fuel source	R904, R907, Butane or Propane Cylinder	CV 470+	CV 470+
Weight	3.5 kg	3.8 kg	3.8 kg
Dimensions open (LxWxH)	49 x 45 x 33 cm	49 x 45 x 33 cm	49 x 45 x 33 cm
Dimensions closed (LxWxH)	49 x 35 x 10 cm	49 x 35 x 10 cm	49 x 35 x 10 cm
Qt. Master carton (units)	5	5	5

# CAMPING COOK CV

The Camping Cook is a great entry stove for those first time campers. This robust, no frills, camping stove offers excellent performance and portability. No need for any setup or additional accessories as the hose and regulator already come firmly attached. Simply connect your easy clic cartridge and you are good to go. With two 1800W independently adjustable burners you can cook up a meal for friends and family in no time.



**Regulator and Hose Included**

Hose and regulator with easy clic connection comes included and attached

Two removable, dishwasher-safe pan supports

Push and turn knobs for full flame control

**Camping Cook CV**  
2000037217

Camping Cook CV	
Reference	2000037217
EAN code	3138522118815
Power	3600 W
Gas consumption	261 g/h
Boil time	6 m 45 s
Ignition	Manual
Runtime	1 h 40 min on CV470
Fuel source	CV470
Weight	1.9kg
Dimensions open (LxWxH)	45 x 30 x 9.6 cm
Qt. Master carton (units)	5





## BASE CAMP™

Pure efficiency with pure focus on cooking performance and stability. Two independent burners with limitless adjustment. The optimal balance of performance and value, a great introduction to the 2 burner stove world of Campingaz®.



**Base Camp™ with Lid**  
2000036708

Convenient lid for easy and clean storage

Compact design for easy transport

Fully adjustable power

Two independent burners

### ALSO AVAILABLE



**Base Camp™**  
2000036709

	Base Camp™ with Lid	Base Camp™
Reference	<b>2000036708</b>	<b>2000036709</b>
EAN code	3138522117207	3138522117214
Country cluster	BE-DK-CZ-ES-FI-FR-GB-GR-IE-LU-NL-NO-PT-UA-SE-ARA	BE-DK-CZ-FI-FR-GB-GR-IE-IT-LU-NL-NO-UA-SE-ARA
Power	2 x 1600 W	2 x 1600 W
Gas consumption	2x 116 g/h	2x 116 g/h
Boil time	7 min 30 s	7 min 30 s
Ignition	Manual ignition	Manual ignition
Runtime	12 hrs 30 min	12 hrs 30 min
Lid	Yes	-
Fuel source	R907	R907
Weight	1.9kg	1.4kg
Dimensions (LxWxH)	43 x 24 x 8 cm	43 x 24 x 7.5 cm
Qt. Master carton	5	5



## BISTRO STOVES

The last version of Campingaz success story, the Camp'Bistro 3, with 2 safety systems integrated, a stainless steel cartridge cover and an upgraded pan support, ensuring stability and a safe usage of the stove. This robust stove comes with its own hard plastic carry case, for easy transport and storage.



Stainless-steel cartridge cover and elevated arms, to prevent any overheating of the cartridge

Double safety to cut gas flow and to eject the cartridge when overheating

Fully adjustable power

Piezo ignition for convenient lighting

Large windshield around the burner

### Camp'Bistro 3 2000038753



Large cooking surface area



Hard plastic carry case included

	Camp'Bistro 3
Reference	2000038753
EAN Code	3138522124403
Country Clusters	FR-GB-NL-DE-IT-ES-PT-DK-NO-SE-FI-CZ-PL-HU-SI-SK-HR-EE-LT-LV-GR-RO-BG-IS
Power	2200W
Gas Consumption	160g/h
Outdoor boiling time	6 min 25
Ignition	Integrated piezo
Runtime	1h20
Fuel source	CP 250
Valve / Knobs	Progressive opening
Dimensions	34,3 x 28,4 x 13,3
Product Weight	1.6 kg
Accessories	Carry Case









# Versatile Urban & Caravan Grilling

Whether you are looking for a space saving grill for your city balcony or practical cooking gear for your caravan kit, we've got the right grills for you.

Explore our wide range of grill and stove combos perfect for small urban outdoor spaces or cozy evenings while on a caravanning adventure. All grills and stoves are supported by our globally available range of gas cartridges and cylinders. Whichever you choose, you can be sure that they're reliable, safe and practical.

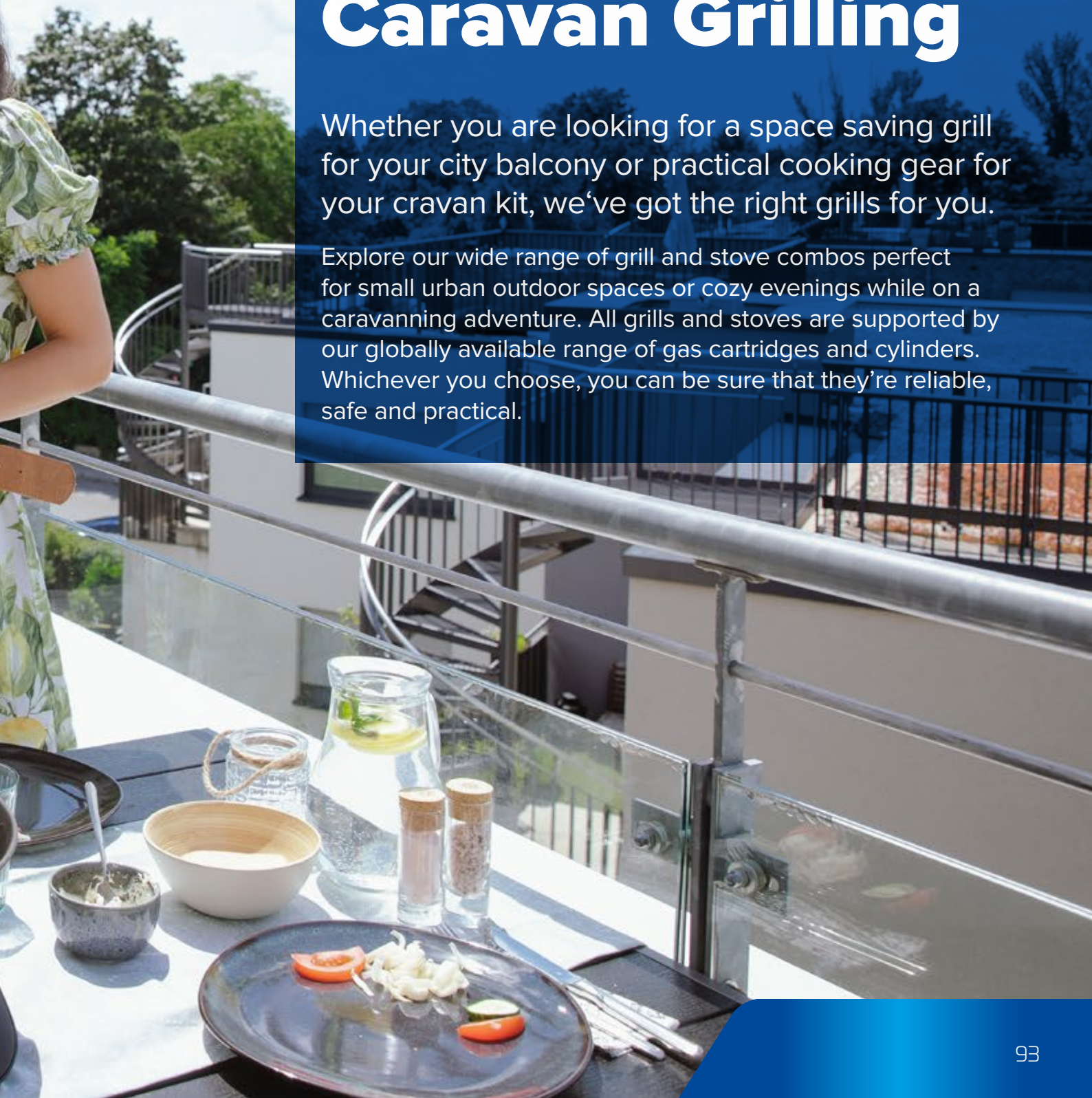



## 360 GRILL RANGE

Introducing the very first table-top style gas grill with a flat design that can be grilled on from 360° while comfortably sitting at the table. The Campingaz® 360 Grill offers extensive grilling and cooking versatility with an included ribbed griddle, flat plancha as well as a pan support for stove cooking. The practical grill comes completely pre-assembled and the sexy, yet simple design ensures it will harmoniously integrate into both close to home urban settings as well as on any caravan adventure. Light, compact and convenient to take along with you wherever the road takes you.



Preassembled table-top grill  
no screwdriver required!

Push & Turn ignition for convenient lighting!

Durable aluminium die-cast reversible riddle with  
non-stick coating

Integrated pan support enables additional and  
practical stove top cooking

Dishwasher safe fire/water bowl ensures quick  
and simple cleaning

360 ring burner with excellent flame distribution  
for even heat diffusion across the entire grill

Protective lid + convenient carry  
and storage bag included.



### **360 Grill CV**

2000038776 (ANTHRACITE)

## ALSO AVAILABLE



### **360 Grill CV**

2000038778 (COPPER)



### **360 Grill**

2000038779 (IRON GREY)



	<b>360 Grill CV</b>	<b>360 Grill CV</b>	<b>360 Grill (30mbar)</b>
<b>Reference</b>	<b>2000038776 (Anthracite)</b>	<b>2000038778 (Copper)</b>	<b>2000038779 (Iron Grey)</b>
<b>EAN</b>	3138522124540	3138522124564	3138522124571
<b>Country cluster</b>	TBC	TBC	TBC
<b>Power</b>	2400W	2400W	2400W
<b>Burner technology</b>	360 ring burner	360 ring burner	361 ring burner
<b>Cooking dimension/size</b>	30cm Ø	30cm Ø	30cm Ø
<b>Configuration</b>	Reversible griddle + pan support	Reversible griddle + pan support	Reversible griddle + pan support
<b>Cooking material</b>	Non-stick die-casted aluminium	Non-stick die-casted aluminium	Non-stick die-casted aluminium
<b>Ignition</b>	Push N Turn ignition	Push N Turn ignition	Push N Turn ignition
<b>Gas consumption</b>	175 g/h	175 g/h	175 g/h
<b>Usage &amp; run time</b>	2 hrs & 30mins on CV470	2 hrs & 30mins on CV470	15 hrs on R907 10 hrs on R904
<b>Fuel source</b>	Campingaz CV 470 cartridges	Campingaz CV 470 cartridges	Campingaz R cylinders/generic gas cylinders
<b>Carry &amp; storage bag</b>	Included Material: Polyester	Included Material: Polyester	Included Material: Polyester
<b>Dimensions (LxWxH)</b>	35 x 35 x 16 cm	35 x 35 x 16 cm	35 x 35 x 16 cm
<b>Weight</b>	5.1 kg	5.1 kg	4.8 kg
<b>Qt. Master carton</b>	1	1	1

## MAIN FEATURES

Convenient cartridge table support



Easy to eject firebowl via lock button aids hassle free cleaning



Fully adjustable power



Integrated EasyClic™ Plus system for easy connection and disconnection of cartridge





## PARTY GRILL™ RANGE

Cooking on the go, on your balcony or wherever you go was never so easy. The Party Grill™ 400 and 200 is available in different powers, sizes and gas formats. The models feature multiple cooking surfaces including a direct stove for pan cooking, grill, griddle, plancha, and the lid even doubles as a wok or oven\*. Lighting the stove is simple, based on the piezo ignition and cleaning the grill is easy thanks to its collect and tip-away cleaning system.

\*Not all models feature all cooking surfaces.

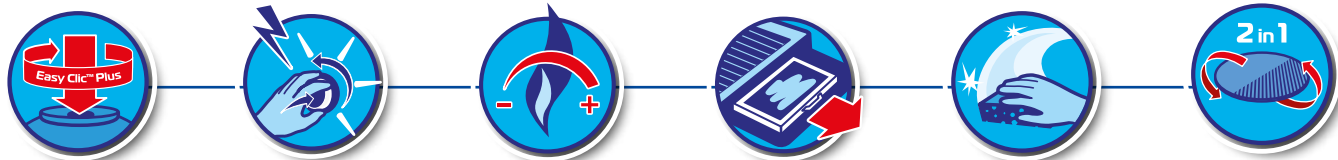

**Party Grill™ 400**  
2000030685

Grill, griddle and stove cooking options

Grill and griddle with non-stick coating for better cooking results

Integrated pan supports for stove top cooking

Fully adjustable power

Water compartment to collect fat

Push & Turn Piezo ignition for convenient lighting

### OPTIONAL ONLY FOR PARTY GRILL™ 600



#### Pizza Stone and Pizza Cutter

Ref: 2000014582

EAN: 3138522069711

Optional accessory for Party Grill™ 600

Ceramic pizza stone

Stainless steel plate + pizza cutter

### ALSO INCLUDED



**Carry Bag (Party Grill™ 600 / 400 / 400 CV)**

### ALSO AVAILABLE



**Party Grill 600**  
2000025701



**Party Grill™ 400**  
2000035499



**Party Grill™ 400 CV**  
2000030685



**Party Grill™ 200**  
2000023716



	<b>Party Grill™ 600</b>	<b>Party Grill™ 400</b>	<b>Party Grill™ 400 CV</b>	<b>Party Grill™ 200</b>
<b>Reference</b>	<b>2000025701</b>	<b>2000035499</b>	<b>2000030685</b>	<b>2000023716</b>
<b>EAN code</b>	3138522088590	3138522085124	3138522096045	3138522085100
<b>Power</b>	4000 W	2000 W	2000 W	2000 W
<b>Gas consumption</b>	290 g/h	145 g/h	145 g/h	145 g/h
<b>Boil time</b>	3 min 50 sec	6 min 5 sec	4 min 18 sec	4 min 18 sec
<b>Ignition</b>	Push & Turn Piezo	Push & Turn Piezo	Piezo	Piezo
<b>Runtime</b>	9 hrs and 30 min. on R907 6 hrs and 15 min. on R904	19 hrs and 30 min. on R907 12 hrs and 30 min. on R904	3 hrs on CV470 1 hr and 40 min on CV300	3 hrs on CV470 1 hr and 40 min on CV300
<b>Fuel source</b>	R904, R907, butane or propane cylinder	R904, R907, butane or propane cylinder	CV470+ CV300+	CV470+ CV300+
<b>Weight</b>	10.72 kg	4.92 kg	4.92 kg	2.84 kg
<b>Dimensions (LxWxH)</b>	Ø 52 x 99 cm (on stand)	Ø 36 x 42 cm (on stand)	Ø 36 x 42 cm (on stand)	Ø 32 x 33 cm
<b>Carry Bag</b>	Included. Material: Polyester	Included. Material: Polyester	Included. Material: Polyester	Not Included
<b>Qt. Master carton</b>	1	2	2	4

## MAIN FEATURES

Non-stick cooking surface



Water compartment to collect the grease and fat ensuring easy cleaning



Fully adjustable power



Folds into compact size for easy transportation



Integrated EasyClic™ Plus system for easy connection and disconnection of cartridge





## VALVE CARTRIDGE STOVES

Stoves that operate off Campingaz® valve cartridges CV300 Plus and CV470 Plus can easily be disconnected and reconnected even when they are not completely empty, which is a major advantage for carrying and storage.



### Piezo ignition

Piezo ignition works by releasing a spring-loaded hammer to strike a spark from crystal, while electronic ignition uses a battery-powered circuit. Piezo ignition sometimes requires more than one press of the button.



Wide pan support for large pots and pans

Piezo ignition for a fast and dependable ignition without a match

4 detachable legs ensure better stability and compact storage



Carry bag included

**Bivouac™**  
203044



Foldable arms for compactness and easy storage

Ultra-lightweight design

Adjustable power

**Bleuet™ Micro Plus**  
204184



#### Bivouac™

Reference	<b>203044</b>
EAN code	3138522030445
Country cluster	AT-BE-CH-DK-DE-ES-FI-FR-GB-GR-IE-IT-LU-NL-NO-SE-PT-MEA-CZ-HR-HU-SL-SK-PL
Power	2600 W
Gas consumption	190 g/h
Boil time	3 min 10 s
Ignition	Piezo
Runtime	1 hr 15 min on CV300+ 2 hrs 20 min on CV470+
Fuel source	CV300+, CV470+
Weight	950g
Dimensions (LxWxH)	Ø 17.5 x 24 cm
Carry Bag	Included. Material: Polyester
Qt. Master carton	6



#### Bleuet™ Micro Plus

Reference	<b>204184</b>
EAN code	3138522041847
Country cluster	BE-DK-FI-GB-IE-LU-NL-NO-SE-IS
Power	1250 W
Gas consumption	90 g/h
Boil time	5 min 30 s
Ignition	Manual ignition
Runtime	2 hrs 40 min on CV300+ 5 hrs on CV470+
Fuel source	CV300+, CV470+
Weight	175g
Dimensions (LxWxH)	Ø 13 x 9 cm
Qt. Master carton	24



## Easy Clic™ Plus



**1. Click.**  
Simply press the appliance into the valve cartridge.



**2. Rotate.**  
Twist the appliance 45° to the left to secure cartridge.



Wide pan supports fold up into carry pod (included).  
Heat screen to protect the knob  
Fully adjustable power



Foldable arms for compactness and easy storage

**Twister™ Plus**  
204187



Same features as the Twister™ Plus but with the added benefit of a Piezo ignition



Foldable arms for compactness and easy storage

**Twister™ Plus PZ**  
204189



Twister™ Plus	
Reference	<b>204187</b>
EAN code	3138522041878
Country cluster	BE-DK-FI-GB-IE-LU-NL-NO-SE-IS
Power	2900 W
Gas consumption	210 g/h
Boil time	3 min 45 s
Ignition	Manual ignition
Runtime	1 hr 10 min on CV300+ 2 hrs on CV470+
Fuel source	CV300+, CV470+
Weight	263g
Dimensions (LxWxH)	Ø 12 x 11 cm
Qt. Master carton	10

Twister™ Plus PZ	
Reference	<b>204189</b>
EAN code	3138522041892
Country cluster	BE-DK-FI-GB-IE-LU-NL-NO-SE-IS
Power	2900 W
Gas consumption	210 g/h
Boil time	3 min 45 s
Ignition	Piezo
Runtime	1 hr 10 min on CV300+ 2 hrs on CV470+
Fuel source	CV300+, CV470+
Weight	215g
Dimensions (LxWxH)	Ø 12 x 11 cm
Qt. Master carton	10



## PIERCEABLE CARTRIDGE STOVES

Used by campers for decades. Our famous Bleuett™ 206 range features Campingaz® exclusive Clip & Go™ system making cartridge connection quicker and easier.



4 strong aerodynamically designed stainless steel pan supports with an integrated windshield

Fully adjustable power

Stable plastic base with cartridge holder

**Camping 206 S**  
40470



### Camping 206 S

Reference	<b>40470</b>
EAN code	5012832549324
Country cluster	FR-DE-AT-GB-IT-ES-PT-BE-NL-LU-Ch-CZ-HU-PL-IE-MEA
Power	1250 W
Gas consumption	90 g/h
Boil time	5 min 30 s
Ignition	Manual ignition
Runtime	2 hrs
Fuel source	C206GLS
Weight	280g
Dimensions (LxWxH)	Ø 13.5 x 19 cm
Qt. Master carton	10



## CYLINDER STOVES

Robust stoves designed to hold large, heavy pans and to operate for longer periods using Campingaz® R904 and R907 refillable cylinders. Easy to use, they screw directly onto the cylinders without the need for a hose or regulator.



Designed to hold large, heavy pans  
Integrated windshield  
Convenient carrying handle

**Super Carena™ R**  
2000033792



Integrated windshield  
4 robust foldable pan supports

**1 Feu™ R**  
27127



### Super Carena™ R

Reference	<b>2000033792</b>
EAN code	3138520314837
Country cluster	IT-ES-PT-GR AT-BE-CH-DE-DK-FR-GB-IE-LU-NL-MEA
Power	3000 W
Gas consumption	220 g/h
Boil time	4 min
Ignition	Manual ignition
Runtime	8 hrs on R904 12 hrs on R907
Fuel source	R904, R907
Weight	600g
Dimensions (LxWxH)	Ø 19 x 11 cm
Qt. Master carton	5



### 1 Feu™ R

Reference	<b>27127</b>
EAN code	3138520271277
Country cluster	FR-DE-AT-CH-GB-IE-ES-PT-BE-NL-LU-DK-GR-CZ- HU-PL-IE-MEA
Power	1350 W
Gas consumption	99 g/h
Boil time	6 min
Ignition	Manual ignition
Runtime	18hrs on R904 27hrs 45 min on R907
Fuel source	R904,R907
Weight	235g
Dimensions (LxWxH)	20 x 11 cm
Qt. Master carton	20



## STOVE CONNECTION ACCESSORIES

No matter which Campingaz® stove you want to connect to while using an appropriate gas fuel source, Campingaz® has the right stove connection accessories for you.



**Regulator Tap Butane 28Mbar  
1300g/h**

Ref: 2000037966  
(GB-IT-PT-BE-NL-LU)

EAN: 3138522120375

Enables low pressure appliances, e.g. Party Grill™ LP range or Base Camp™ stove, to operate off Campingaz® refillable cylinders. Excess flow cut-off device. Simply screws onto the cylinder (R901, R904 or R907).



**Gas Hose and Regulator Kit**

Ref: 68280

EAN: 03138520682806

Standard kit including 29mbar regulator and 80mm hose.



# COOKING ACCESSORIES

Ingeniously compact, stackable and light, our cooking accessory pot sets offer the choice of non-stick, stainless steel or aluminium.

## Trekking Kit 8 Pieces Hard Anodised Aluminium

Ref: 202030

EAN: 3138522020309

(GB, FR, DE, NL, IT, CZ, FI, DK, SE, NO, PL, SK, HU)

For increased abrasion and corrosion resistance.

- 3 pots Ø 18 cm (2.8L), 16 cm (1.3L) and 13 cm (1L)
- 3 lids Ø 19, 17 and 14cm
- 1 pan Ø 18 cm
- Kit packed: H19 x L13cm
- Weight: 1.3kg
- Not suitable for dishwasher
- Carry bag included. Material: Polyester



Carry bag included



## Camping Cook Set 9 Pieces Non Stick Coated

Ref: 202025

EAN: 3138522020255

(GB, FR, DE, NL, IT, ES, PT, CZ, FI, DK, SE, NO, SI, SK)

**Ideal for families or larger groups where kit isn't being carried.**

- 2 lids Ø 23 and 21cm
- 3 pots Ø 22 cm (5L), 20 cm (2.5L) and 14 cm (1L)
- 2 pans Ø 22 and 20cm
- 1 universal handle
- Carry bag included
- Kit packed: H29 x L16cm
- Weight: 1.95kg
- Not suitable for dishwasher
- Carry bag included. Material: Polyester



Carry bag included



## Trekking Kit 5 Pieces Aluminium

Ref: 202031

EAN: 3138522020316

(GB, FR, DE, NL, IT, CZ, FI, DK, SE, NO, PL, SK, HU)

- 2 pots Ø 17 cm (1.8L) and 14 cm (1.2L)
- 1 pan Ø 18cm
- 1 lid Ø 16cm
- 1 handle
- 1 strap
- Kit packed: H19 x L11cm
- Weight: 570g
- Not suitable for dishwasher





CAMPINGAZ®







# Coolers

Cold, hot, large, small, rigid, soft, electric, traditional, funky, plain... we've got them all.

All our coolers are built to last and offer high performance at great value. Whether you're camping or just out in the countryside for the day, keeping your food and drink chilled is a basic luxury, and with a wide selection available, you'll find the right cooler for all occasions.



## THE RIGHT COOLER...

Whether you are on a campsite, travelling by car or undertaking a spontaneous day trip - the Campingaz® cooler ranges cover all your needs for different occasions, just choose the right one:



**AM** | ANTIMICROBIAL  
LINER  
PROTECTION  
LIMITED TO PRODUCT



### Thermoelectric coolers

Thanks to an integrated cooling system, Thermoelectric coolers offer a longer, excellent performance for your camping holiday and are treated with an antimicrobial liner. They can be plugged into:

- A car cigarette lighter
- A 230Vac via a transformer (integrated or sold separately)



## Hard coolers

The Campingaz® hard coolers are perfect for a weekend trip to keep your food and drinks fresh.

A wide range covers your individual needs and offers performance for your camping holiday:

- Antimicrobial treated lining only on Icetime Plus Extreme coolers
- Excellent insulation
- Superior quality supported by numerous tests



**Freez'Pack™ will increase your cooling performance**



## Soft coolers

A great combination of superior insulation, lightweight textiles and attractive designs for outings and short trips:

- Antimicrobial treated lining on all Tropic and Sand soft cooler ranges
- Easy to carry thanks to its lightness
- Easy storage due to foldable system and flexible shoulder strap
- Easy to clean thanks to seamless inner liner and fabrics used
- Different designs ranging from 'Classic' to 'Fashion' meeting your individual desires



A guide to the new Campingaz® TE and passive cooler ranges

## CAMPINGAZ® THERMOELECTRIC AND HARD-SIDED COOLERS

Campingaz® lineup of stylish & sleek, high performance electric and passive coolers, jam-packed with brand new features from the lid to the base! With the long-standing tradition and heritage for cooling performance from Campingaz®, campers, picnic-goers, and vacationers alike can rest assured their food and drinks will stay cool for the whole journey!



## FOUR MODE ADJUSTABLE COOLING PERFORMANCE

The Campingaz Powerbox™ Plus AC/DC hard cooler features

a control dial with 4 modes, allowing you to choose the performance and efficiency level. The coolers can be turned off by putting the dial on “OFF” mode without the need to unplug the cord.

To reduce the noise level of the fan switch to “NIGHT” mode. The internal fan operates at a 36db level, which is quieter than the suggested night noise level by WHO (World Health Organization)

For an efficient, yet environmental friendly operation, the “ECO” mode can be used, giving an A++ energy rating.

“MAX” mode is available for the ultimate cooling performance.



## THICK, PREMIUM PU HARD COOLER INSULATION

Tests show that cooling loss is significant through the base of coolers.

Campingaz® models feature an increased insulation base and have two integrated, rounded feet providing the perfect amount of space for air to flow.

All Campingaz® hard coolers are constructed with Polyurethane (PU) insulation material, the highest quality insulation material available on the market — utilising more insulation on each of our new coolers than competitors!

Our Icetime™ Plus Extreme coolers are also equipped with a PU-insulated lid for an extra boost of performance.

Prior to assembling, the PU is injected into the casing of the cooler; whereas most competitors use Expanded Polystyrene – EPS which is 20% less effective than our PU insulated coolers.

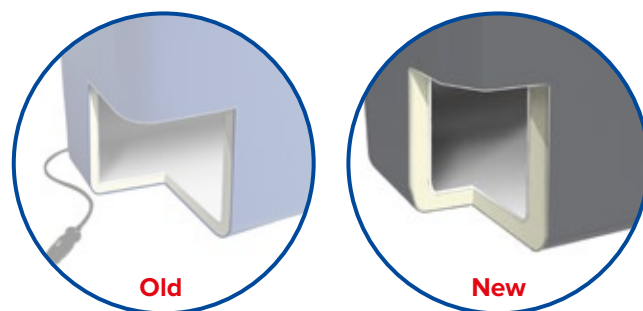

Increasingly more PU insulation compared to prior and competitor models.



**POWERBOX™ PLUS**



**ICETIME™ PLUS**

## SOFT COOLER INSULATION

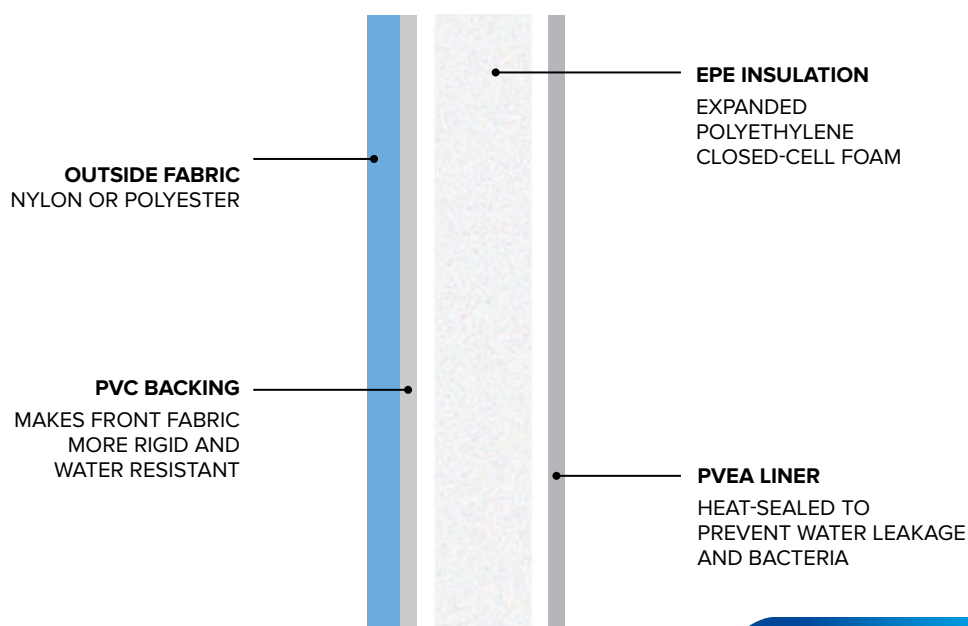



## ANTIMICROBIAL LINER

Campingaz® was the first TE cooler on the market to contain an antimicrobial liner which resists the formation of mould, mildew, and unpleasant odours which may develop from bacteria inside a cooler.

Our non-toxic, safe to use, antimicrobial effect is obtained from an additive which is melted down into the plastic before it's moulded into the liner and it's a lifetime treatment. It cannot be scratched off or weakened over time.



**ANTIMICROBIAL  
LINER  
PROTECTION  
LIMITED TO PRODUCT**



## FREEZE GUARD

---

An integrated sensor protects cooler contents from being frozen  
Includes: Powerbox™ Plus 12V/230V

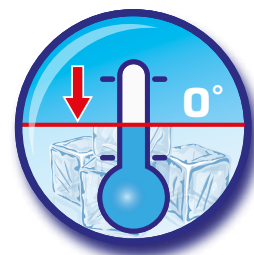

## BATTERY SAVER

---

An electronic chip senses when a car battery does not have enough charge  
start ignition and shuts off power to the TE cooler.



t o

## NEW HINGED LIDS AND WIDE LID OPENING

---

Snug fit handle for convenient storage, wide mouth for easy filling.  
Includes: All new Campingaz® Passive and Electric coolers.



## CLICK 'N LOCK

---

Lid emits clicking sound when closing for reassurance.  
Includes: All new Campingaz® Passive and Electric coolers





## THERMOELECTRIC COOLERS

The Campingaz Powerbox™ Plus AC/DC active cooler range operates off a 12V car plug-in or a 230V electrical outlet (both cables included), combined with the high-performance injected PU foam, the coolers will keep contents at 19°C below the ambient temperature. They feature a control dial with 4 modes, allowing you to choose the performance and efficiency level. The coolers can be turned off by putting the dial on “OFF” mode without the need to unplug the cord. To reduce the noise level of the fan switch to “NIGHT” mode, and for an efficient, yet environmental friendly operation, the “ECO” mode can be used, giving an A++ energy rating. “MAX” mode is available for the ultimate cooling performance. Assembled in Italy.



**Powerbox™ Plus 36L**  
**12/230V**  
2000037448



**Powerbox™ Plus 36L 12/230V**

Reference	<b>2000037448</b>
EAN code	3138522119751
Capacity	36L
Fit	10
Features	Thick, premium PU insulation, runs off a 12V car plug-in or a 230V wall outlet, built in transformer, four mode adjustable cooling performance, locking lid that 'clicks' on close, antimicrobial liner, two side handles, assembled in Italy
Insulation	PU
Insulation performance (+/- °C)	19 degrees below ambient temperature
Weight	5.2kg
Outer Dimension (LxHxW)	55.9 x 40.4 x 34.8 cm
Inner Dimension (LxHxW)	46.7 x 29 x 27.5 cm
Qt. Master carton	1

Inhibiting the ability of microorganisms to grow, many Campingaz® coolers feature an Antimicrobial Liner, a powerful protection ensuring resistance to mould and mildew growth inside the coolers and it also blocks unpleasant odours from developing.



**ANTIMICROBIAL  
LINER  
PROTECTION  
LIMITED TO PRODUCT**

An antimicrobial additive is melted down into the plastic before it's moulded into the liner to ensure that it's "there for life" and cannot be scratched off or weakened over time.



## Powerbox™ Plus 28L 12/230V

2000037452



### Powerbox™ Plus 28L 12/230V

Reference	<b>2000037452</b>
EAN code	3138522119768
Capacity	28L
Fit	8
Features	Thick, premium PU insulation, runs off a 12V car plug-in or a 230V wall outlet, built in transformer, four mode adjustable cooling performance, locking lid that 'clicks' on close, antimicrobial liner, overhead bail handle, assembled in Italy
Insulation	PU
Insulation performance (+/- 1°C)	19 degrees below ambient temperature
Weight	3.8kg
Outer Dimension (LxHxW)	40.8 x 46.9 x 32.3 cm
Inner Dimension (LxHxW)	32.8 x 34.8 x 24.3 cm
Qt. Master carton	1



# THERMOELECTRIC COOLERS

The Campingaz® thermoelectric cooler range is packed with 30% more premium insulation than its predecessor. When plugged into your car or into the main electricity port via a transformer, they keep their contents 20°C below the ambient temperature. The improved and very quiet fan emits a maximum of 39 dB, that won't wake you up at night! The power cord and plug can also be easily removed and conveniently stored inside the cooler during non-use. The 12V easily removable cord can be quickly stored inside the cooler when not in use.



The Campingaz® thermoelectric coolers also have a breakthrough, antimicrobial liner that resists odour, mould and mildew. The antimicrobial additive is injected into the plastic of the liner, meaning it's there for the life of the cooler – it can never be scratched off or removed. With a new and modern shape built from strong and thick polypropylene these coolers stay cool for hours even when unplugged.



Thicker and improved PU insulation

Integrated feet to elevate cooler from ground and create an additional insulation layer of air

Rounded edge design for a more modern look and brings food closer to the center with the utmost cooling performance

Firm locking lid

Noise reduced fan

Integrated storage for cable

**Powerbox™ Plus 36L**  
2000024957

**35% more cooling performance**



Powerbox™ Plus 36L	
Reference	2000024957
EAN code	3138522087111
Capacity	36L
Fit	10
Insulation	PU
Features	Thick, premium PU insulation, locking lid that "clicks" on close, antimicrobial liner resists odour, mould & mildew, two-side handles, modern Campingaz® look and design, assembled in Italy
Insulation performance (+/- 1°C)	22° delta versus outside ambient temperature
Weight	4.8kg
Outer Dimension (LxHxW)	55.9 x 40.4 x 34.8 cm
Inner Dimension (LxHxW)	46.7 x 29 x 27.5 cm
Qt. Master carton	1

## ALSO AVAILABLE

### Euro Transformer 230Vac/12Vdc

Ref: 203164 Continental Europe EAN: 3138522031640  
 Ref: 203442 United Kingdom EAN: 3138522034429

Indispensable accessory for use with a thermoelectric cooler. Plug-in and the thermoelectric cooler runs on 230Vdc mains supply.

- Output power: 13Vdc x 5A = 65W
- Size 15.5 x 10 x 6.5 cm (L x W x H)





## Powerbox™ Plus 28L

2000024956

**25% more cooling performance**



## Powerbox™ Plus 24L

2000024955

**30% more PU insulation**



	Powerbox™ Plus 28L	Powerbox™ Plus 24L
Reference	2000024956	2000024955
EAN code	3138522087104	3138522087098
Capacity	28L	24L
Fit	8	8
Insulation	PU	PU
Features	Thick, premium PU insulation, locking lid that “clicks” on close, antimicrobial liner resists odour, mould & mildew, ball handle for easy transportation on 24/28, modern Campingaz® look and design, assembled in Italy	Thick, premium PU insulation, locking lid that “clicks” on close, antimicrobial liner resists odour, mould & mildew, ball handle for easy transportation on 24/28, modern Campingaz® look and design, assembled in Italy
Insulation performance (+/- °C)	20° delta versus outside ambient temperature	20° delta versus outside ambient temperature
Weight	3.7kg	3.6kg
Outer Dimension (LxHxW)	40.8 x 46.9 x 32.3 cm	40.8 x 42.3 x 32.3 cm
Inner Dimension (LxHxW)	32.8 x 34.8 x 24.3 cm	32.8 x 31 x 24.3 cm
Qt. Master carton	1	1



# ICETIME™ PLUS COOLERS

Sporting a modern style from Campingaz®, the Icetime™ Plus coolers are perfect for a day-long picnic or a trip to the beach. With a tough outer shell and packed with premium PU insulation, this cooler will keep your contents fresh all day long! The convenient bail handle design makes transportation a breeze no matter how much content you put in your cooler. Recommended for use with Campingaz Freez'Packs™. Made in Italy.



**Icetime™ Plus 30L**  
2000024963

**50% more PU insulation**



**Icetime™ Plus 26L**  
2000024962

**125% more PU insulation**



	<b>Icetime™ Plus 30L</b>	<b>Icetime™ Plus 26L</b>
<b>Reference</b>	<b>2000024963</b>	<b>2000024962</b>
<b>EAN code</b>	3138522087173	03138522087166
<b>Capacity</b>	30L	26L
<b>Fit</b>	6	6
<b>Features</b>	Thick, premium PU insulation, bail handle for easy transportation on 24/28, locking side handles for 36L, modern, refreshed Campingaz® look and design, made in Italy	Thick, premium PU insulation, bail handle for easy transportation on 24/28, locking side handles for 36L, modern, refreshed Campingaz® look and design, made in Italy
<b>Insulation</b>	PU	PU
<b>Insulation performance (+/- 1°C)</b>	27 hours	24 hours
<b>Weight</b>	2.6kg	2.4kg
<b>Outer Dimension (LxHxW)</b>	40.8 x 46.9 x 32.3 cm	40.8 x 42.3 x 32.3 cm
<b>Inner Dimension (LxHxW)</b>	32.8 x 36.6 x 24.3 cm	32.8 x 32.9 x 24.3 cm
<b>Qt. Master carton</b>	1	1

## ISOTHERM EXTREME COOLERS

The Isotherm Extreme coolers keep contents cool all day thanks to high quality insulation and an integrated airtight seal. A tough outer shell offers increased durability and it includes a built in storage tray and rack for efficient packing. An incorporated drain makes it easy to clear out and a sturdy handle doubles up as a safety locking device.



Lid locking handle

Integrated airtight seal

PU insulation for superior performance

Leak-proof inner food box can be removed and cleaned

### ALSO AVAILABLE

**Isotherm Extreme**  
**17L**  
22254



**Isotherm Extreme**  
**10L**  
30060



**Icetime™ 13L**  
39401



	<b>Isotherm Extreme 17L</b>	<b>Isotherm Extreme 10L</b>	<b>Icetime™ 13L</b>
<b>Reference</b>	<b>22254</b>	<b>30060</b>	<b>39401</b>
<b>EAN code</b>	3138520222545	3138520300601	3138520394013
<b>Capacity</b>	17L	10L	13L
<b>Fit</b>	Holds 11 x 0.5L bottles	Holds 7 x 0.5L bottles	Holds 0.5L bottles vertically
<b>Features</b>	Includes lid locking handle	Includes lid locking handle	
<b>Insulation</b>	PU	PU	
<b>Insulation performance (+/- °C)</b>	20 hrs 30 min with Freez'Pack® units (1x M10 + 1x M20) (sold separately)	17 hrs with Freez'Pack® units (2x M10) (sold separately)	17 hrs with Freez'Pack® units (1x M10 + 1x M20) (sold separately)
<b>Weight</b>	2.1kg	1.4kg	1.9kg
<b>Dimensions (LxHxW)</b>	36.3 x 37 x 24.3 cm	30.6 x 32 x 20.5 cm	29 x 18 x 39 cm
<b>Qt. Master carton</b>	1	1	1



# THE JASMIN RANGE

This stylish range will keep your food cool while adding extra fashion to your summer. The new range is not only stylish, but it also follows the sustainability trend. Using recycled material for both the fabric and the insulation, these coolers will be the trend of the summer. You will want to take these everywhere!



**The Box 3L**  
2000038326



**The Backpack 9L**  
2000038329



	THE BOX - 3L	THE BACKPACK - 9L
Reference	<b>2000038326</b>	<b>2000038329</b>
EAN code	3 13852 212080 1	3 13852 212083 2
Capacity	3L	9L
Outer Material	recycled post-consumer plastic bottles polyester	recycled post-consumer plastic bottles polyester
Insulation	recycled polyester fiber	recycled polyester fiber
Fit	6 bottles of 33 cl	8 bottles of 0,5 L
Benefit	first soft cooler range using fabrics made from recycled materials	first soft cooler range using fabrics made from recycled materials
Insulation performance (+/- 1°C)	6h	6h
Weight	250 g	440 g
Dimensions (LxWxH)	190x155x120 mm	300x320x140 mm
Qt. Master carton	12	12





# THE JASMIN RANGE

This stylish range will keep your food cool while adding extra fashion to your summer. The new range is not only stylish, but it also follows the sustainability trend. Using recycled material for both the fabric and the insulation, these coolers will be the trend of the summer. You will want to take these everywhere!



**The Shopping Bag 12L**  
2000038327



**The Maximax 17L**  
2000038330



	THE SHOPPING BAG - 12L	THE MAXIMAX BAG - 17L
Reference	<b>2000038327</b>	<b>2000038330</b>
EAN code	3 13852 212081 8	3 13852 212084 9
Capacity	12L	17L
Outer Material	recycled post-consumer plastic bottles polyester	recycled post-consumer plastic bottles polyester
Insulation	recycled polyester fiber	recycled polyester fiber
Fit	6 bottles of 0,5 L	10 bottles of 0,5 L
Features	first soft cooler range using fabrics made from recycled materials	first soft cooler range using fabrics made from recycled materials
Insulation performance (+/- 1°C)	11h	11h
Weight	440g	510g
Dimensions (LxWxH)	255/355x270x195 mm	330/320x295x195/140 mm
Qt. Master carton	12	12



CAMPINGAZ®



## THE OFFICE RANGE

Our cooler bags from The Office range are the perfect companions to take to work and fit the occasion.

Not only your drinks and food will stay pleasantly cool, but the modern and urban design makes them a real eye-catcher. These cooler bags offer a great solution to stay trendy while bringing your lunch everywhere.

The outer part of the bags is made of a high-quality polyester – the inner part is equipped with an antimicrobial additive that reduces the development of odors, fungi and mold.



**Shopping bag 16L**  
2000036879



**Messenger bag 17L**  
2000036892



	Shopping bag	Messenger bag
Reference	<b>2000036879</b>	<b>2000036892</b>
EAN code	3138522117856	3138522117870
Capacity	16 L	17 L
Insulation	6mm EPE closed cell foam	6mm EPE closed cell foam
Fit	4 x 1.5L	7 x 1.5L
Features	Bike attachable with high grade velcro, transparent top cover for maps and phones, non insulated side pocket, reflective snap.	Shoulder strap, fully zipped top, non insulated side pockets for accessories.
Insulation performance (+/- 1°C)	10h	12h with Freez'Pack™
Weight	400g	550g
Dimensions (LxWxH)	19 x 38 x 31 cm	16 x 43 x 33 cm
Qt. Master carton	12	12



**Coolbag**  
2000036875



Coolbag	
Reference	2000036875
EAN code	3138522117818
Capacity	9 L
Insulation	6mm EPE closed cell foam
Fit	12 x 33cl
Features	QR buckle to attach to bag, adjustable strap, non insulated front pocket, fully zipped top
Insulation performance (+/- 1°C)	9h with Freez'Pack™
Weight	380g
Dimensions (LxWxH)	17 x 30 x 21 cm
Qt. Master carton	12





## CLASSIC SOFT COOLERS

Our classic soft coolers are comfortable to carry and come in a variety of shapes and sizes. When you're finished, many of them fold up to be stored away easily.



**Fold'N Cool™ 30L**  
2000011725

**Fold'N Cool™ 20L**  
2000011724

**Fold'N Cool™ 10L**  
2000011723

**Fold'N Cool™ 5L**  
2000011722



	Fold'N Cool™ 30L	Fold'N Cool™ 20L	Fold'N Cool™ 10L	Fold'N Cool™ 5L
Reference	2000011725	2000011724	2000011723	2000011722
EAN code	3138522063177	3138522063160	3138522063153	3138522063146
Capacity	30L	20L	10L	5L
Insulation	6mm EPE closed-cell foam insulation	6mm EPE closed-cell foam insulation	6mm EPE closed-cell foam insulation	6mm EPE closed-cell foam insulation
Fit	Holds 9 x 1.5L bottles vertically and 12 x 1.5L horizontally	Holds 6 x 1.5L bottles vertically and 5 x 1.5L horizontally	Holds 8 x 0.5L bottles vertically and 10 x 0.5L horizontally	Holds 6 x 0.33L bottles vertically or horizontally
Features	12 hrs 45 min with Freez'Pack™ units (sold separately)	12 hrs with Freez'Pack™ units (sold separately)	10 hrs with Freez'Pack™ units (sold separately)	6 hrs with Freez'Pack™ units (sold separately)
Insulation performance (+/- °C)	Foldable cooler, adjustable shoulder strap	Foldable cooler, adjustable shoulder strap	Foldable cooler, adjustable shoulder strap	Foldable cooler, adjustable shoulder strap
Dimensions (LxHxW)	760g	620g	390g	310g
Weight	24.9 x 39.2 x 38.2 cm	19.6 x 32.2 x 37 cm	17.9 x 31.3 x 24.5 cm	15.5 x 23.4 x 19.2 cm
Qt. Master carton	8 -1 x merch of 8	12 -2 x merch of 6	16 -2 x merch of 8	12 -1 x merch of 12



**Coolbag 13L**  
2000011726



**Bacpac 14L**  
2000011728



**Bottle 1.5L**  
2000011727



	Coolbag 13L	Bacpac 14L	Bottle 1.5L
Reference	2000011726	2000011728	2000011727
EAN code	3138522063184	3138522063207	3138522063191
Capacity	13L	14L	1.5L
Insulation	6mm EPE closed-cell foam insulation	6mm EPE closed-cell foam insulation	6mm EPE closed-cell foam insulation
Fit	Holds 3 x 1.5L bottles vertically	Holds 3 x 1.5L bottles vertically	Holds 1 x 1.5L bottles
Features	Foldable cooler, one large central opening, large front pocket, 2 side handles	Foldable cooler, adjustable shoulder strap, one large front pocket	Foldable cooler, adjustable shoulder strap
Insulation performance (+/- 1°C)	11hrs 45min with Freez'Pack™ units (sold separately)	10 hrs 20 min with Freez'Pack™ units (sold separately)	4 hrs with Freez'Pack™ units (sold separately)
Weight	570g	570g	210g
Dimensions (LxHxW)	15.2 x 44.6 x 35.4 cm	13.3 x 31 x 41.8 cm	11.4 x 34.4 x 21 cm
Qt. Master carton	12 -1 x merch of 12	12 -2 x merch of 6	12 -1 x merch of 12



**Freez'Pack™ M5, M10, M20, M30**

Ref: 39040 M5 x2 EAN: 3138520390404 Ref: 9377 M10 EAN: 3138520093770

Ref: 9378 M20 EAN: 3138520093787 Ref: 21628 M30 EAN: 3138520216285

**For keeping drinks, food or medicines cool for longer in your passive hard or soft cooler.**

- Food-safe materials
- Dishwasher proof
- Reusable
- Components: water, carboxymethylcellulose, acticide and blue colorantv







CAMPINGAZ®







# Lanterns

Our Campingaz® lanterns brighten your outdoor adventures and camping trips.

Explore our great range of cylinder and cartridge lanterns and find what suits your individual needs best.



# VALVE CARTRIDGE LANTERNS

We offer a complete range of valve cartridge appliances covering most consumer uses. They're equipped with a high security self-sealing valve, so they can be easily and safely disconnected and reconnected whether they're empty or not.



## Piezo ignition

Piezo ignition works by releasing a spring-loaded hammer to strike a spark from crystal, while electronic ignition uses a battery-powered circuit. Piezo ignition sometimes requires more than one press of the button.

## Easy Clic™ Plus



### 1. Click.

Simply press the appliance into the valve cartridge.



### 2. Rotate.

Twist the appliance 45° to the left to secure cartridge.



- Easy access to mantle
- Strong & reliable with integrated globe protection guard
- Piezo Ignition
- Convenient carrying chain



Carry bag included



- Strong & reliable with integrated globe protection guard
- Integrated hanging/carrying handle

## Lumostar™ Plus PZ

2000039136



Lumostar™ Plus PZ	
Reference	2000039136
EAN code	3138522124878
Country cluster	FR / DE / GB / IT / ES / PT / NL / CZ / PL
Power	80 W
Gas consumption	38 g/h
Ignition	Piezo
Runtime	6 hrs 20 min on CV300+ 12 hrs on CV470+
Fuel source	CV300+, CV470+
Weight	379g
Dimensions (LxWxH)	Ø 10 x 17 cm
Carry Bag	Included. Material: Polyester
Qt. Master carton	10

## Lumogaz™ Plus

2000039135



Lumogaz™ Plus	
Reference	2000039135
EAN code	3138522124861
Country cluster	FR / GB / DE / IT / NL / DK / GR
Power	80 W
Gas consumption	38 g/h
Ignition	Manual ignition
Runtime	6 hrs 20 min on CV300+ 12 hrs on CV470+
Fuel source	CV300+, CV470+
Weight	280g
Dimensions (LxWxH)	Ø 16 x 10 cm
Qt. Master carton	10





## PIERCEABLE CARTRIDGE LANTERNS

Lanterns that operate off pierceable cartridges are an economical single-use option – lanterns can be turned on and off, however the cartridges cannot be disconnected.



Globe protection guard

Integrated hanging handle

Large, robust base for extra stability

### Camping 206 L

2000035218



#### Camping 206 L

Reference	<b>2000035218</b>
EAN code	03138522113261
Country cluster	GB-FR-IE-DE-AT-CH-NL-IT-BE-LU-GR-CY-CZ-UA-ARA
Power	80 W
Gas consumption	38 g/h
Ignition	Manual ignition
Runtime	5 hrs
Fuel source	C206GLS
Weight	470g
Dimensions (LxWxH)	Ø 12 x 26 cm
Qt. Master carton	10



## LANTERN ACCESSORIES

Campingaz® lantern accessories include globes and mantles that help to extend the life of Campingaz® products and are compatible with all of our lanterns.



**Gas mantle Size M, S**

Pack of 3 mantles for Campingaz® lanterns

Ref: **68222** Size M EAN: 3138520682226

Ref: **68221** Size S EAN: 3138520682219



**Round globe M**

Ref: **204478** 85mm Ø EAN: 3138522044787

BRAND	SKU	NAME	MANTLE S	MANTLE M
<b>CURRENT MODELS</b>				
CAMPINGAZ	204193/204194	LUMOGAZ® PLUS LANTERN	X	
CAMPINGAZ	204195/2000035224	LUMOSTAR® PLUS PZ LANTERN	X	
CAMPINGAZ	204689	LUMOGAZ® R PZ LANTERN	X	
CAMPINGAZ	2000035218	LANTERN CAMPING 206	X	
<b>PAST MODELS</b>				
CAMPINGAZ	204191/2000010182	LUMOSTAR® PLUS LANTERN	X	
CAMPINGAZ	204683	CAMPING 206 LANTERN	X	
CAMPINGAZ	204687	SUPER LUMO 206 PZ LANTERN	X	
CAMPINGAZ	204696	BLEUET® CV300 LANTERN	X	
CAMPINGAZ	204697	BLEUET® CV300 PZ LANTERN	X	
CAMPINGAZ	na	BIVOUAC®	X	
CAMPINGAZ	na	L 470		X
CAMPINGAZ	na	LUMOGAZ 270, N 206, T 206, R, RPZ, 470	X	
CAMPINGAZ	na	LUMOSTAR C, M	X	
CAMPINGAZ	na	MINIGAZ® 106	X	
CAMPINGAZ	na	MONT BLANC®	X	
CAMPINGAZ	na	RHAPSODY® 470		X
CAMPINGAZ	na	SOLEIO®	X	
CAMPINGAZ	na	SOLEIO® R		X
CAMPINGAZ	na	SUN FORCE®		X
CAMPINGAZ	na	SUPER LUMOGAZ® 206	X	
CAMPINGAZ	na	SYMPHONY®, SUPER SYMPHONY®		X



CAMPINGAZ®





A man with dark hair and a beard, wearing a grey shirt, is sitting on a light blue airbed inside a white tent. He is looking towards the camera with a slight smile. In the foreground, there are two woven straw hats and a pair of sunglasses. To the right, a yellow and grey backpack is visible. The background shows the interior of the tent and a glimpse of the outdoors.

# Airbeds & Pumps

A beautiful camping location is even better after a good night's sleep.

Our airbeds are light but tough and come in a range of sizes to suit all situations. Our 'Airtight™ System' means that they're not only comfortable, they're also guaranteed leak free, so you won't be let down in the night.



## QUICKBED™ AIRBEDS

Campingaz inflatable airbeds are light but tough, perfect for taking camping or as a spare bed for when friends come to stay. Choose from a range of sizes (including an extra large one for taller people).

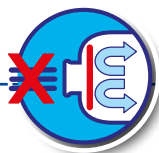

Airtight<sup>™</sup> System

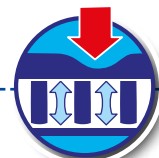

Internal coil structure



Pillow for better comfort

Easy to access storage space under the pillow

Flocked PVC on top

Coil structure maximises comfort

Integrated Airtight<sup>™</sup> System prevents unwanted deflation

Strong PVC makes the airbed more resistant against punctures

### **X'tra Quickbed Airbed Double**

2000021961

### **ALSO AVAILABLE**



### **X'tra Quickbed™ Airbed Single**

2000021959

# Airbeds & Pumps



**Quickbed Airbed Double**  
205481

Flocked PVC on top

Coil structure maximises comfort

Integrated Airtight™ System prevents unwanted deflation

Strong PVC makes the airbed more resistant against punctures

Snap 'N' Stay™ feature for attaching together

## ALSO AVAILABLE



**Quickbed Airbed Single**  
205480

	Reference	EAN code	Weight	Dimensions L x I	Repair Kit
<b>X'tra Quickbed™ Airbed Double</b>	<b>2000021961</b>	3138522082598	3.5kg	198x137 cm	Included
<b>X'tra Quickbed™ Airbed Single</b>	<b>2000021959</b>	3138522082574	1.8kg	198x74 cm	Included
<b>Quickbed™ Airbed Double</b>	<b>205841</b>	3138522082581	3.1kg	188x137 cm	Included
<b>Quickbed™ Airbed Single</b>	<b>205480</b>	3138522082567	1.6kg	188x74 cm	Included

## Pump™

204474

### Rechargeable QuickPump™ Air Pump

Ref: 204474

EAN: 3138522044749

**An extra powerful electric pump for faster inflation (and deflation), with a rechargeable power unit.**

- 230V AC charger included
- Hose and carry bag included
- Additional Double Lock™ valve and pinch valve adapters included to use pump without hose
- Runtime: 30 minutes (when fully charged)
- Airflow: 600 litres per minute
- Head pressure: 39mBar
- Weight: 1.7kg





CAMPINGAZ®

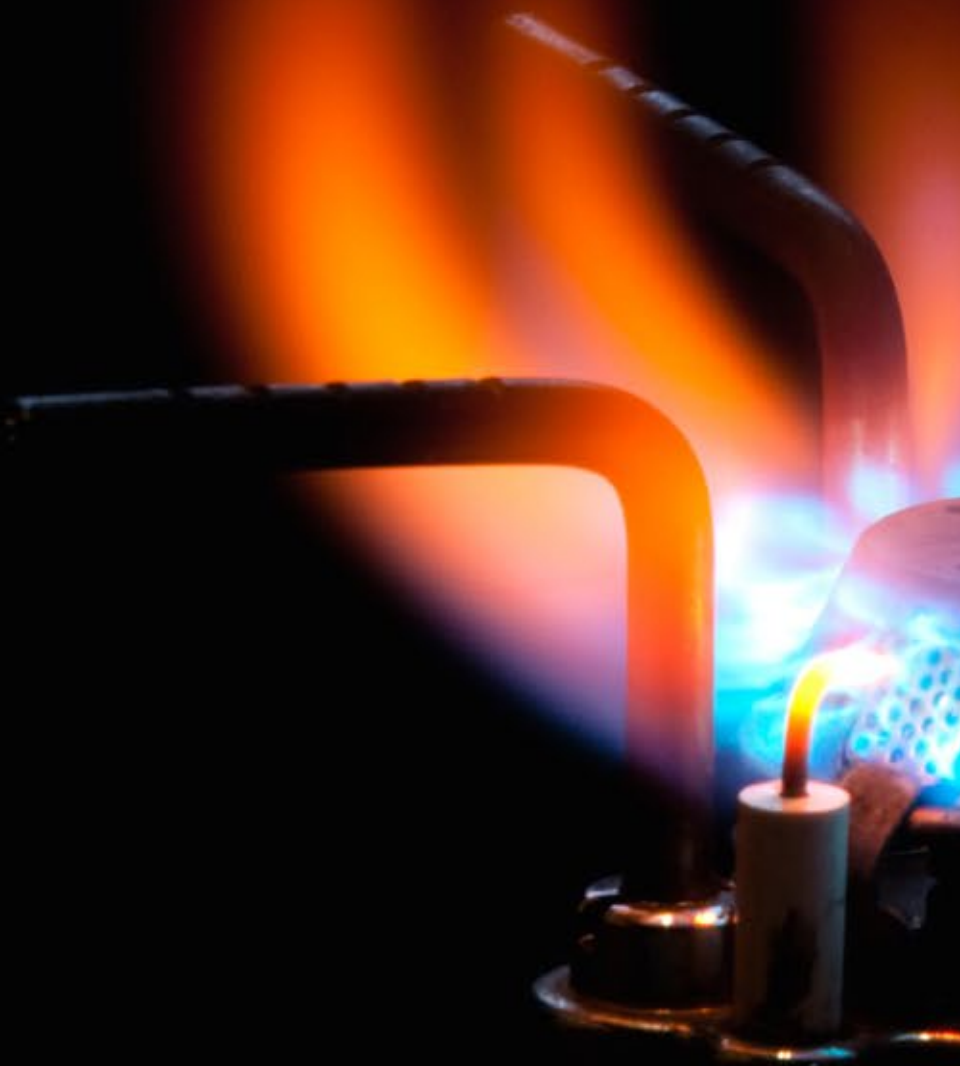

# Help section

- Pictograms recap
- Glossary
- Sku List
- Standard terms and conditions of sale





## CARTRIDGES FEATURES

**Refillable cylinders:** Intended for regular use or for extended operating times. Available in most European countries.



R901



R907



R904



Butane/  
Propane

**Valve cartridges:** Featuring a self-sealing valve, they can be disconnected and reconnected even when not empty!



CV300  
Plus



CV360



CV470  
Plus



CG1750



CP250



CG3500

**Pierceable cartridges:** Single use cartridge with the exclusive Clip & Go™ system makes cartridge connection and replacement very easy and user friendly.



C206



C206 GLS



**Easy Clic™ Plus:** Simple method for attaching a valve cartridge



1. Click.  
Simply press the appliance into the valve cartridge.



2. Rotate.  
Twist the appliance 45° to the left to secure cartridge.



**Screw in system for the cylinder connection**

## TYPE OF IGNITION



**Piezo ignition:** In a traditional piezo ignition, a small hammer hits against a crystal which creates a small spark that is used to ignite the gas. This always happens with an easily recognizable sound. Sometimes it needs more than one push to successfully ignite the gas with a piezo ignition.



**Electronic ignition:** Easy start due to a battery-powered circuit. A battery-powered tension is used to create a spark. The typical noise here is a silent clicking.



**InstaStart™ ignition:** This special type of electronic ignition is a convenient push and turn-button lighting system designed specifically for our BBQ grills. Pushing the button creates a spark. Turning the same button starts the flow of gas, that then ignites the spark to become a flame.



**Push & Turn Piezo ignition:** This special type of ignition is a convenient push and turn-button lighting the system designed specifically for our gas stoves. Pushing the button creates a spark. Turning the same button starts the flow of gas, that then ignites the spark to become a flame.

## BBQ FEATURES



**RBS™ healthy cooking:** Only our Radiant Burner System barbecues offer side-mounted, ceramic burners promoting healthy cooking with fewer flare-ups



**SBS - Campingaz® SEARING BOOST STATION FOR MASTER SERIES BARBECUE**



**Cast iron burners**



**Stainless steel burners**



**Standard burners**



**Patented blue flame burner for Master Plancha series**



**Indoor and outdoor use for more flexibility**

## STOVE FEATURES



**Side burner:** More cooking possibilities with a side burner that can be used for pots and pans.



**Even Temp<sup>®</sup> Technology:** Even heat distribution across the entire cooking surface.



**Less flare ups:** Designed for healthier cooking with less flaring from the burners.



**Campingaz InstaClean<sup>™</sup> System:** Removable dishwasher safe parts.



**Easy clean:** Can be washed and cleaned easily.



**Campingaz<sup>®</sup> Culinary Modularity:** Experience different cooking possibilities with exchangeable inserts.



**Thermometer**



**Side tables:** Side tables included.



**Foldable side tables:** Fold away for space saving storage.



**Slidable side tables:** Slide away for space saving storage.



**Included Plancha spatula and convenient spatula holder**



**Number of people that can be served per grilling session**



**Illuminated control knobs**



**Xcelerate<sup>™</sup> Technology:** The combination of the Xcelerate<sup>™</sup> burner and wind blocking pan supports provide the ultimate wind resistance for your gas stove offering a much faster boil time than regular burners.



**Integrated windshield system**



**Power adjustable:** Fully adjustable power.



**Boiling time:** Takes 3min and 3sec until boiling (numbers will vary)



**Quick cooking:** Quick cooking using a powerful burner.



**Stopgaz<sup>™</sup>:** for added safety, the gas cuts off automatically if the flame is blown out.



**Regulator and hose included**



**Two burner stove with two powerful burners**



**Toaster:** Includes toaster.



**Lid:** Includes collapsible lid



**Weight:** Product weight.



**Easy to carry:** Convenient carrying and easy storage.



**Fat collecting:** Fat collecting system for healthier cooking.



**Stable and tough base for better stability when cooking and working on uneven surfaces**



## AIRBED FEATURES



**Airtight™ System:** Advanced Double Lock™ valve with two sealing points guaranteeing a leak-free product. Makes inflation and deflation fast and simple.



**Coil structure:** All of our airbeds have an internal coil structure, ensuring firmness and comfort all night long.



## COOLER FEATURES



A non-toxic and safe antimicrobial treatment on the liners to stop mildew, mould, and odour-forming bacteria.



**12Vdc:** Runs off 12Vdc car cigarette lighter.



**12Vdc/230Vac:** Can be used in 230Vac mode with an 230Vac/12Vdc transformer.



**Capacity:** Capacity of the cooler, indicated by the amount of litres that the cooler can hold.



**Capacity:** Capacity of the cooler, indicated by numbers of bottles that the cooler can hold.



**Cooling performance:** Guarantees 17 hours (numbers will vary) temperatures below 15°C (with Freez'Pack).



**Cooling function:** The outside temperature minus 18 degrees Celsius (number varies between products) equals the temperature inside the cooler.



**WARRANTY APPLICATION TERMS AND CONDITIONS:** Please refer to the Instruction Manual. To find out more about our warranty visit [www.campingaz.com](http://www.campingaz.com) and view the After Sales section.









## STANDARD TERMS & CONDITIONS OF SALE

1. **ENTIRE AGREEMENT.** The party to whom goods are being sold, either by means of electronic data interchange or a traditional paper transaction is "Buyer." We are "Seller." The terms and conditions stated herein supplement Seller's sales agreement ("Vendor Agreement") specific to Buyer and together the terms and conditions and the Vendor Agreement constitute the entire agreement between Buyer and Seller ("Agreement"). In the event of conflict between the Agreement and those contained in any other proposal, purchase order, invoice, acknowledgement, or writing, this Agreement shall control. Any change to or addition of the Agreement must be in a separate writing and signed by both parties hereto.

2. **SELLER'S TERMS PREVAIL.** THE PURCHASE OF SELLER'S GOODS IS EXPRESSLY CONDITIONED ON BUYER'S ASSENT TO THIS AGREEMENT. ANY ADDITIONAL AND/OR DIFFERENT TERMS AND CONDITIONS ARE HEREBY EXPRESSLY REJECTED. BUYER SHALL BE DEEMED TO HAVE ACCEPTED THE AGREEMENT THE EARLIER OF SELLERS' ACKNOWLEDGEMENT OF THE ORDER AND BUYER'S RECEIPT OF GOODS.

3. **ASSIGNMENT.** Buyer shall not assign any sales order or any part thereof including, but not limited to any obligations to make any payment(s) due or to become due hereunder, without the written consent of Seller.

4. **PRICES.** Prices and terms are subject to change without notice. Seller will endeavour to provide Buyer with 30 days notice. The price to be applied shall be that which is in force on the date of delivery. Unless otherwise expressly accepted by Seller, Prices are quoted either : (i) ex-works dispatching place (Incoterms 2010-ICC), at which time Prices are exclusive of all transportation, insurance, taxes, license fees, customs fees, duties and other charges related thereto. Buyer shall pay any and all freight charges to the final destination and hold Seller harmless therefrom; or (ii) FOB port of shipment (Incoterms 2010-ICC) when Seller may offer merchandise for sale direct from Asia, at which time Seller only bears the expense of moving the container(s) to the named port in the country of origin.

Prices are for products only and do not include technical data, proprietary rights of any kind, or patent rights. Seller's intellectual property rights shall remain its absolute unencumbered property and nothing contained herein shall give Buyer any right, title or interest in or to Seller's intellectual property right.

5. **PAYMENT.** Products are invoiced on each delivery in USD, Euro or any other currency agreed by Seller. TIME IS OF THE ESSENCE for Buyer to pay Seller for the goods. The agreed upon payment terms are stated in the Vendor Agreement and on the invoice. In the absence of any such statement, payment is due in full within sixty (60) days from date of invoice by cheque, bank transfer, draft or any other mean of payment expressly accepted by Seller. In the event Buyer fails to make timely payment on one or more of Seller's invoices, Seller shall have the right to accelerate all outstanding payments Buyer owes to Seller and make such payments immediately due and payable, regardless of payment terms. Seller reserves the right to require payment by letter of credit, cash on delivery or other suitable payment terms and otherwise modify credit terms or to suspend production, shipment or delivery if prompt payment is not made. When partial shipments are made, payments for such partial shipments shall become due in accordance with the terms stated herein.

Seller does not ship any merchandise on consignment. All orders are accepted with any credit terms extended subject to the approval of the Seller's Credit Department. All late payments shall incur an interest charge of at least three (3) times the legal interest rate increased by 5 points, invoiced to Buyer without any formality. The interest rate stated herein shall continue to accrue after Seller obtains a judgment against Purchaser. The Seller has the right to exercise setoff or recoupment when needed to satisfy an outstanding debt.

6. **PURCHASE MONEY SECURITY INTEREST.** All products remain Seller's property until full payment thereof by the Buyer (price, interest and incidental expenses). Title to the products shall pass to the Buyer upon full payment.

To secure the performance of its obligations hereunder, Buyer hereby grants to Seller a security interest in all of its inventory of goods purchased hereunder for which Seller has not received payment pursuant to Section 5 hereof ("Secured Inventory"). Buyer warrants that all Secured Inventory will be owned by Buyer free of all other liens, security interests, and encumbrances that are prior to that of Seller. All of the Secured Inventory will be kept at the facilities, the addresses of which will be delivered to Seller at its request; but Seller's lien and security interest will be maintained despite the location of the Secured Inventory. Except for sales made in the regular course of business, Buyer shall not sell, encumber or dispose of or permit the sale, encumbrance or disposal of any Secured Inventory of goods without the prior written consent of Seller. In the event that Buyer sells Secured Inventory in the regular course of business, Buyer shall identify other inventory of value equal to that of the sold Secured Inventory as collateral for the security interest, which inventory then will be treated as Secured Inventory under this Paragraph 6. Buyer agrees to execute any instruments requested by Seller from time to time for purposes of further evidencing such security interest or notifying third parties by recordation or otherwise of such security interest

7. **UNAUTHORIZED DEDUCTIONS.** Seller does not recognize any deduction or penalty policies of Buyer other than a fully executed agreement and this Agreement. Should Buyer take an unauthorized deduction from a payment to Seller, Seller will reject the claim as invalid. Buyer will repay any such deduction immediately upon notification from Seller. Unauthorized deductions that are not immediately repaid will be deducted from any available credits due Buyer, including but not limited to, agreed upon merchandise returns or sales program allowances. Seller reserves the right to suspend shipments to Buyer until the unauthorized deduction(s) is repaid in full.

8. **RIGHT TO AUDIT.** Any disputes by Buyer shall be submitted to Seller in writing with proper documentation within one year of the invoice date. All Buyer claims received more than one year after the invoice date are waived.

9. **FREIGHT TERMS.** Unless otherwise accepted by Seller, sales of products are made ex-works dispatching place (Incoterms 2010-ICC) or FOB port of shipment (Incoterms 2010-ICC) when Seller may offer merchandise for sale direct from Asia. The Buyer must take delivery of the products and bear all risks of loss of or damage to the products from the time they've been rendered at the dispatching place. The Buyer shall issue a specific cargo insurance policy for any damage to the products from the time they've been rendered at the dispatching place; it is therefore the Buyer's obligation to submit claims for damages or shortages directly to their contracted carrier for any shipments. Seller is subrogated in the Buyer's rights towards his insurer. In the event that Seller procures insurance against the Buyer's risk of loss of or damage to the products during the carriage, the Buyer undertakes to (i) check the products on delivery (defects and/or shortages) and to (ii) immediately notify Seller of any transportation reserve.

10. **DELIVERY.** Delivery dates are approximate and shall be computed from the date of acceptance of the order by the Seller. Seller will deliver promptly on acceptance of each order. Seller will use its reasonable best efforts to fill all orders according to their terms. However, if any conditions arise which prevents compliance with the delivery schedule, Seller shall not be liable for damages, general, incidental, consequential, compensatory or otherwise, or for failure to give notice of any delay and Seller shall have such additional time within which to perform as may be reasonably necessary under the circumstances and shall have the right to apportion its production among its customers in such a manner as it considers equitable. Seller shall also have the right to deliver the goods in instalments including but not limited to, delivering from multiple origins.

11. **PRODUCT RETURNS.** Products in new condition (including but not limited to overstock, shelf worn or shelf damaged goods, or previously unsold obsolete goods) or defective goods may not be returned to Seller without prior written authorization and instructions properly issued by Seller. Seller shall not accept returned products except in accordance with such authorization and instructions. In the event of a rejection of any of the Products, risk of loss shall remain upon Buyer until the returned Products are accepted by Seller. Unless otherwise agreed, Seller will not bear any charges from the Buyer associated with the return, including transport costs, special handling fees or storage fees. Seller shall decide, at its exclusive option, if the products are to be replaced.

12. **RIGHT TO CANCEL.** Seller is under no obligation to grant Buyer's request to cancel or change quantities on previously submitted and accepted orders. If in its sole discretion, Seller allows Buyer to cancel all or a portion of an order and the work, delivery preparation, labelling or loading has already begun or is complete, Seller reserves the right to charge the Buyer restocking fees.

a. **Hold to Confirm Orders ("Booking Orders").** Seller will accept Booking Orders for mutual planning of future deliveries to Buyer. Booking orders may not be changed within 15 (fifteen) days of delivery, including but not limited to, changes to the quantity ordered or the mix of goods ordered. The requested delivery date on Booking Orders may not be changed. At no time may the value of the Booking Order be changed by virtue of quantity reductions, substitutions or item cancellation, so as to reduce the overall value more than 10% (ten percent) of the original submitted value.

b. **Manufactured to order cannot be cancelled or changed once the Buyer has confirmed the order.**

In addition to all other rights and remedies available to it, Seller reserves the right to cancel the order immediately by written notice to the Buyer in case of failure of the Buyer to perform or comply with any of the terms or conditions herein.

13. **PROPRIETARY GOODS.** Seller may agree at its sole discretion to produce or procure Special Make Up ("SMU") goods for Buyer. SMU goods may include but are not limited to a proprietary colour, carton markings, design or combination of multiple finished goods sold as a single selling unit. Buyer and Seller will collaboratively plan the lead-time production and sales forecast for the SMU items. Seller will produce or procure the forecasted quantities. Buyer agrees to purchase the total amount of SMU goods forecasted for the calendar year. If Buyer's orders have not consumed the forecast for the SMU items by December 1st of the given year, Buyer will immediately place an order for the balance to deliver from Seller by the end of the calendar year.

14. **SALE OF EXCESS OR OBSOLETE GOODS.** Seller may offer from time to time, close out purchases of excess, obsolete or discontinued goods ("E&O"). Orders for E&O goods are filled on a first come, first served basis. To secure the E&O goods, Buyer must submit a firm order before any other customer's order for the same goods.

15. **DIVERSION OF GOODS, LIMITATION ON RESALE.** Seller maintains sales relationships with a wide variety of retailers, wholesalers, discounters and distributors. Unless otherwise expressly agreed by Seller, Buyer agrees not to resell the goods on a whole-sale basis and understands that the goods may be specially coded to identify them as goods sold to Buyer. Should Buyer resell goods on a wholesale basis without being expressly authorized by Seller, Buyer shall pay damages to Seller in the amount equal to the difference between the price at which Buyer purchased the goods from Seller and the price which Seller could have received from the party to which Buyer sold the goods at wholesale, together with all reasonable attorneys' fees, costs of investigation and expenses expended by Seller to enforce this provision.

16. **INTERNET SALES.** With prior written approval from Seller, Buyer may use and display Seller's logos and trademarks ("Marks") in connection with the marketing, distribution and sale of goods online. Buyer acknowledges that all such Marks are the exclusive property of Seller. Any product descriptions or pictures ("Content") provided by Seller for use on Buyer's website(s) is the exclusive copyright protected property of Seller. Use of any of the Seller's Marks in any Uniform Resource Location ("URL"), domain name, trade name, or business name is prohibited without express prior written consent of Seller. Seller reserves the right not to establish new business relationships with Internet only Buyers that have no physical store locations and/or do not maintain an inventory of goods

17. **NO EXPORT OF GOODS.** Buyer agrees and represents that the goods sold hereunder are sold solely for use and consumption within Europe and are not for export outside of Europe, regardless of method of sale including Internet sales. Buyer further understands that Seller's consumer warranty is only valid for consumers in Europe unless Seller has explicitly stated otherwise in writing. Buyer is aware that the goods are not designed to comply with the requirements for sale in any other jurisdiction than the respective markets in which they are sold. If Seller is made aware, through any means, that Buyer is exporting goods purchased from Seller without the express written consent of Seller, Seller reserves the right to cancel all outstanding orders from Buyer and to refuse all future orders. If Seller has given its written authorization for Buyer to export the goods outside of Europe, Buyer shall comply with all export laws and regulations including, but not limited to, export licensing requirements, and Buyer shall be responsible for any goods' compliance or non-compliance with applicable laws in the country to which such goods are exported. Buyer agrees not to resell the goods to a country or person prohibited from engaging in commerce with the United States.

18. **PRESENCE ON SELLER'S PREMISES.** If Buyer's performance hereunder requires the presence of Buyer, its employees, agents or subcontractors upon Seller's premises, Buyer (and its employees, agents and subcontractors) shall comply with all relevant laws and with Seller's policies and internal procedures. Buyer shall also take such further precautions necessary or reasonable to prevent any personal injury or property damage from occurring as a result of the presence of Buyer, its employees, agents and/or subcontractors on Seller's premises. Any such precautions that Buyer takes which affect Seller's property or operations shall require Seller's prior consent. Buyer shall indemnify Seller for any and all damages, losses, costs and expenses, including attorneys' fees and expenses and costs of investigation, which Seller suffers or incurs in any way which result, in part or whole, from an act or omission of Buyer, its employees, agents or subcontractors. Buyer shall maintain such Commercial General Public Liability, Workers' Compensation and Employer's Liability Insurance as will protect Seller from any and all such liability. Buyer shall provide Seller with proof of coverage upon Seller's written request.

19. **NO AGENCY.** Nothing in the Agreement shall create or be deemed to create any relationship of agency, partnership or joint venture and Buyer will bear all of its expenses in connection herein. In this context, Buyer shall be solely responsible for the remuneration of its employees and for paying all expenses and outlays whatsoever of said employees, which are not connected in any way whatsoever with Seller. Buyer shall hold Seller harmless for any claim which would be directed against it by an employee at anytime during or after the Agreement.

This Agreement shall not have any authority to assume or create any obligation, express or implied, on behalf of Seller. Buyer shall not make quotations or write letters over the name of Seller but in every instance shall use its own name.

20. **INDEMNIFICATION.** Buyer shall indemnify, defend and hold Seller harmless from and against any and all claims, damages (including incidental and consequential damages), losses, costs and expenses (including reasonable attorneys' fees) which Seller may suffer or incur arising out of: (i) any breach of the terms and conditions herein by Buyer; (ii) any acts or omissions by Buyer, its employees, agents or subcontractors; (iii) any alteration(s) to the goods not authorized by Seller; (iv) Buyer's removal of or failure to include any and all instructions and warnings regarding the goods and provided by Seller; (v) Buyer's oral or written instructions or warnings inconsistent with those provided by Seller; (vi) goods that have been damaged by Buyer or those that have been damaged by a consumer and/or returned by a consumer after a retail sale; and/or (vii) Buyer's or Buyer's customer's failure to comply with all applicable laws, rules, regulations or ordinances.

21. **WARRANTIES.** Seller warrants: (i) that the goods delivered pursuant hereto are

manufactured in accordance with applicable laws and regulations; and (ii) that Buyer, upon full payment of the purchase price therefore, will receive title to the goods. Seller may provide the retail purchaser of the goods with a consumer warranty, as set forth in the packaging or labelling of such goods. Seller MAKES NO OTHER WARRANTY, EITHER EXPRESS OR IMPLIED, WITH REGARD TO THE GOODS DELIVERED PURSUANT HERETO. SELLER EXPRESSLY DISCLAIMS THE IMPLIED WARRANTIES OF MERCHANTABILITY AND FITNESS FOR A PARTICULAR PURPOSE. IN NO EVENT SHALL SELLER BE RESPONSIBLE TO BUYER OR TO ANY PARTY FOR INCIDENTAL, CONSEQUENTIAL, SPECIAL OR PUNITIVE DAMAGES. Seller's sole responsibility and Buyer's exclusive remedy for breach of this warranty shall be the offer of an update for or the repair or replacement of such products or, if neither of the foregoing is feasible in Seller's reasonable discretion, refund of the purchase price paid for such products. Except for Seller's limited warranty accompanying the products, this warranty and the remedies identified herein is in lieu of all warranties, terms or conditions, express or implied, either in fact or by operation of law, statutory or otherwise, including warranties, terms or conditions of merchantability, fitness for a particular purpose and satisfactory quality.

22. **EFFECTIVENESS.** Any term(s) or condition(s) set forth herein which is/are invalid or unenforceable shall be ineffective only to the extent of such invalidity or lack of enforceability and shall not render invalid or unenforceable the remaining terms and conditions.

23. **FORCE MAJEURE.** Seller shall not be considered in default hereunder or be liable for any failure to perform or delay in performing any provisions of this Agreement in the customary manner to the extent that such failure or delay shall be caused by an act of God; fire, explosions, hostilities or war (declared or undeclared); or striking or work stoppage involving its employees. Seller shall use every reasonable means to resume full performance of this Agreement as promptly as possible; it being understood that Seller shall be entitled to automatically cancel the order after a (3) three months period of suspension.

24. **LAW/DISPUTE RESOLUTION.** The rights and duties of the parties to this transaction shall be determined by the laws of the Seller's country without regard to conflict of law principles. Any and all disputes arising in connection with this transaction shall be decided by the relevant Courts in the Seller's country.

25. **CONFIDENTIALITY.** Buyer shall hold the terms and conditions of this Agreement, including but not limited to the pricing, offered discounts, other sales program specifics or selling and distribution practices or methodologies of Seller confidential for any and all purposes excepting those purposes necessary to the fulfilment hereof.

Data privacy protection. Buyer recognizes and agrees that Seller may collect, use, store and transfer personally and non-personally identifiable information that Buyer may voluntarily provide during the course of their business relationship. The Seller will do its best endeavors to adequately protect such information, in the conditions set forth under a Privacy Policy that the Buyer may consult on the website [www.coleman.eu](http://www.coleman.eu). The Privacy Policy outlines the information that Seller may collect and in which conditions the Seller may use that information.

26. **FAILURE TO ENFORCE AGREEMENT.** Failure by Seller at any time or from time to time to enforce or require strict observance and performance of any term or condition of this Agreement will not constitute a waiver of or affect such term or condition in any way, nor shall such failure affect the right of Seller to avail itself at any time of such remedies as it may have for any breach of such terms or conditions by Buyer.





**Benelux & Nordic  
Coleman Benelux B.V.**

Minervum 7168 - 4817 ZN Breda  
THE NETHERLANDS  
Tel: +31 76 572 85 00  
infobnl@newellco.com

## ISO 9001

### Quality Management System Approved by LRQA

Over the years, Campingaz® has demonstrated its commitment to customer satisfaction by focusing on the quality and safety of its products. Application des Gaz (Saint Genis Laval, France) and Camping Gaz Italia (Centenaro di Lonato, Italia) have both been awarded Iso 9001 certificates in recognition of their quality assurance programmes which are applied to every stage of product design, manufacturing, quality control, development and delivery.

The Quality Management System is applicable to design, inter-company purchasing or sourcing, industrialization, manufacturing, storage and distribution of gas appliances and other outdoor leisure and camping products, barbecue and accessories. LPG cartridges, gas cylinders, DIY appliances and accessories under the Campingaz® brand name.



Due to our policy of continuous improvement, Application des Gaz reserves the right to alter or change the specifications of models shown. Some articles may vary in availability and specification from country to country. Please check with your local Campingaz® organization for further details. All pictures are non-contractual. All trademarks contained herein are the property of their respective owners.